

## DOCUMENT RESUME

ED 068 087

08

JC 720 240

AUTHOR Sainsbury, John C.  
TITLE A Vocational Technical Institute Developmental Program for Commercial Fisheries. Final Report.  
INSTITUTION Rhode Island Univ., Kingston.  
SPONS AGENCY National Center for Educational Research and Development (DHEW/OE), Washington, D.C.  
BUREAU NO BR-6-2166  
PUB DATE Jul 72  
CONTRACT OEG-1-6-062166-1994  
NOTE 314p.

EDRS PRICE MF-\$0.65 HC-\$13.16  
DESCRIPTORS Curriculum Design; \*Curriculum Development; \*Fisheries; \*Junior Colleges; \*Marine Technicians; \*Vocational Education  
IDENTIFIERS \*Rhode Island

## ABSTRACT

This document describes the development of a 2-year vocational-technical program in commercial fisheries designed to reduce the traditional training period for fishermen, educate and train future captains for the fishing fleets, and improve the technical and general education level of fishermen. A 72-credit curriculum was developed, three-quarters of which consisted of applied commercial fisheries coursework. All graduating students either entered the fishing industry, an associated marine industry, or continued their education. A wide range of employment opportunities were identified. Staff requirements, qualities, and potential recruitment sources were established. Laboratory facilities, including a wide range of equipment, were developed at a waterfront location and a training vessel, used as a floating laboratory, was outfitted to undertake all principal methods of commercial fishing. Recommendations were developed for establishment of future programs of a similar nature. (Author/RN)

U.S. DEPARTMENT OF HEALTH,  
EDUCATION & WELFARE  
OFFICE OF EDUCATION  
THIS DOCUMENT HAS BEEN REPRODUCED EXACTLY AS RECEIVED FROM THE PERSON OR ORGANIZATION ORIGINATING IT. POINTS OF VIEW OR OPINIONS STATED DO NOT NECESSARILY REPRESENT OFFICIAL OFFICE OF EDUCATION POSITION OR POLICY.

ED 068087

FINAL REPORT  
Project No. 6-2166  
Grant No. OEG 1-6-062166-1994

A VOCATIONAL TECHNICAL INSTITUTE  
DEVELOPMENTAL PROGRAM FOR  
COMMERCIAL FISHERIES

John C. Sainsbury  
UNIVERSITY OF RHODE ISLAND  
Kingston, R.I. 02881

July 1972

The research reported herein was performed pursuant to a grant with the Office of Education, U.S. Department of Health, Education and Welfare. Contractors undertaking such projects under Government sponsorship are encouraged to express freely their professional judgement in the conduct of the project. Points of view or opinions stated do not, therefore, necessarily represent official Office of Education position or policy.

JC 720 240

U.S. DEPARTMENT OF  
HEALTH, EDUCATION, AND WELFARE

Office of Education  
National Center for  
Educational Research and Development

UNIVERSITY OF CALIF.  
LOS ANGELES

NOV 29 1972

CLEARINGHOUSE FOR  
JUNIOR COLLEGE  
INFORMATION

## ABSTRACT

Describes the development of a two-year, vocational-technical program in commercial fisheries, designed to reduce the traditional training period for fishermen, to educate and train future captains for the fishing fleets and to improve the technical and general education level of fishermen. A 72-credit curriculum was developed, three-quarters of which consisted of applied commercial fisheries coursework. Of 96 students entering the program during a period of four years, 50 percent graduated and all entered the fishing industry, an associated marine industry, or continued education. A wide range of employment opportunities were identified. Staff requirements, qualities and potential recruitment sources were established. Laboratory facilities, including a wide range of equipment, for subject areas found necessary, were developed at a waterfront location, which was considered essential. A training vessel was outfitted to undertake all principal methods of commercial fishing, berthed adjacent to the facilities, and used as a floating laboratory. Recommendations were developed for establishment of future programs of a similar nature.

## PREFACE

Funding for the development of the two-year, Associate Degree Program in Commercial Fisheries under this project was provided through the U.S. Office of Education, and the University of Rhode Island. The program is now continuing as part of the general teaching program at the University.

The interest and assistance of the fishing industry has been a vital factor leading to any success that has been achieved during the project, and a special acknowledgement is due to the Point Judith Fishermen's Cooperative Association for their continued support.

As with most acknowledgements, many people who have made important contributions to the project will remain anonymous; however, particular recognition is due to the following who have been deeply involved in the activities for up to five years:

- Dr. James W. Cobble, Dean, College of Resource Development
- Dr. Andreas A. Holmsen, Professor, Resource Economics
- Capt. Geoffrey A. Motte, Assistant Professor, Fisheries & Marine Technology
- Mr. Albert A. Hillier, Assistant Professor Equivalent, Fisheries & Marine Technology
- Mr. James A. McCauley, Assistant Professor Equivalent, Fisheries & Marine Technology
- Dr. Thomas L. Meade, Associate Professor, Fisheries & Marine Technology
- Mr. Robert W. Merriam, Assistant Professor, Fisheries & Marine Technology
- Mr. Richard A. Wing, Special Assistant, Fisheries & Marine Technology
- Mr. Robert Taber, Commercial Fisheries Extension Specialist
- Mr. Thomas Stout, Instructor, Fisheries & Marine Technology

## TABLE OF CONTENTS

Chapter	Page
I. BACKGROUND . . . . .	1
II. HISTORY . . . . .	4
Initial Activities . . . . .	5
Preparations for First Students . . . . .	6
Initial Teaching Activities . . . . .	8
Second Year's Activities . . . . .	11
Third Year's Activities . . . . .	13
Fourth Year's Activities . . . . .	16
Completion of Program Development . . . . .	17
III. STAFF . . . . .	19
Professional Fisheries Personnel . . . . .	19
Personnel in Other Colleges and Departments . . . . .	20
Staff Requirements . . . . .	20
The Position of the Student Counselor/Evaluator . . . . .	24
Qualities, Availability and Recruitment of Faculty . . . . .	25
Technicians . . . . .	29
Secretarial Positions . . . . .	29
IV. CURRICULUM . . . . .	31
Procedure for Major Curriculum Revisions . . . . .	32
Procedure for Minor Changes . . . . .	34
Development of Final Curriculum . . . . .	35
The First Major Revision . . . . .	39

TABLE OF CONTENTS (cont.)

Chapter	Page
IV. CURRICULUM (cont.)	
Experience with the Curriculum Following First Major Revision . . . . .	41
The Second Major Revision . . . . .	44
The Final Curriculum . . . . .	46
Subject Outlines . . . . .	47
V. STUDENTS . . . . .	51
Admission . . . . .	51
Grading and Required Achievement Levels . . . . .	54
Performance . . . . .	55
Effect of Performance on Student Numbers and Section Size . . . . .	57
Criteria for Graduation . . . . .	58
Employment and Achievement of Graduates . . . . .	60
Placement of Graduates . . . . .	64
Recruitment . . . . .	66
Faculty/Student Relationship . . . . .	70
The Student Association and Activities .	71
Experimental Summer Program for High School Students . . . . .	72
VI. FACILITIES . . . . .	74
Location of Waterfront Facilities . . .	74
Construction of Facilities . . . . .	75
The Completed Facilities . . . . .	76
Detailed Description of Facilities . . .	81

TABLE OF CONTENTS (cont.)

Chapter	Page
VII. TRAINING VESSELS . . . . .	98
Development of Training Vessel "Gail Ann" . . . . .	99
Operation of the Training Vessel "Gail Ann" . . . . .	103
Operation of 57-Foot Commercial Vessel . . . . .	112
Choosing and Outfitting a Training Vessel . . . . .	113
VIII. EVALUATION . . . . .	118
Acceptance by Industry . . . . .	119
Capability of Graduates . . . . .	121
Self Study . . . . .	121
The United States Coast Guard . . . . .	124
New England Resource Center for Occupational Education . . . . .	125
National Sea Grant Program . . . . .	126
IX. CONCLUDING REMARKS AND RECOMMENDATIONS . .	127
Industry Support . . . . .	127
Development of Associated Programs . . . .	128
Opportunities for Graduates . . . . .	130
Future of the Program . . . . .	133
Value as a Regional Program . . . . .	134
Need for Additional Programs in the United States . . . . .	135
Establishing a Program . . . . .	136

TABLE OF CONTENTS (cont.)

	Page
APPENDIX A: The Advisory Council . . . . .	143
APPENDIX B: List of Professional Fisheries Personnel Based in the Depart- ment of Fisheries & Marine Technology . . . . .	146
APPENDIX C: Class Schedules . . . . .	158
APPENDIX D: Individual Employment History of Graduates . . . . .	165
APPENDIX E: Courses Dropped During Curriculum Revisions . . . . .	170
APPENDIX F: Summer Cooperative Education Experience . . . . .	173
APPENDIX G: Complete Course Descriptions . . .	190
APPENDIX H: Samples of Final Examination Papers . . . . .	279
APPENDIX J: Student Data . . . . .	303
APPENDIX K: List of Scholarships . . . . .	311
APPENDIX L: Equipment List . . . . .	313
APPENDIX M: Training Vessel Particulars . . .	318
APPENDIX N: Report of Survey Evaluation by New England Resource Center for Occupational Education . . .	329
APPENDIX O: Donation Sources . . . . .	332



## LIST OF TABLES

Table	Page
1. Student Faculty Ratio During Program Development . . . . .	23
2. Original Curriculum (1967) . . . . .	36
3. Curriculum Following First Major Revision . . . . .	40
4. Final Developed Curriculum . . . . .	45
5. Admissions Data . . . . .	53
6. Student Performance Data . . . . .	55
7. Performance of Graduates . . . . .	56
8. Students Commencing Each Semester's Work of the Program . . . . .	57
9. Distribution of Graduates to Industry and Further Education . . . . .	61
10. Distribution of Graduates to Fishing Industry and Associated Industries . . . . .	62
11. Students Entering Program by Geographical Area . . . . .	67
12. Estimated Annual Operating Costs for Two-Year Commercial Fisheries Program . . . . .	142

## LIST OF FIGURES

Figure	Page
1. Area Plan of Wickford Facility . . . . .	77
2. Arrangement Plan of Buildings . . . . .	78
3. View of Wickford Facility . . . . .	79
4. Net Storage . . . . .	79
5. Display Case in Reception Area . . . . .	82
6. Electrical Laboratory . . . . .	82
7. Seamanship Laboratory . . . . .	84
8. Wall Displays in Seamanship Laboratory . .	84
9. Electronics Aids Laboratory (looking west) . . . . .	85
10. Electronics Aids Laboratory (looking east) . . . . .	85
11. Radar Room . . . . .	86
12. Lecture Room . . . . .	86
13. Navigation Laboratory . . . . .	88
14. Building Number 2 from Entrance . . . . .	90
15. Fishing Gear Laboratory . . . . .	90
16. Mast and Boom Assembly . . . . .	91
17. Scale Model Nets . . . . .	91
18. Rhode Island Trap Net . . . . .	92
19. Engineering Technology Laboratory . . . . .	93
20. Hydraulic Teaching Facility . . . . .	93
21. Welding Shop . . . . .	95
22. Tool Room . . . . .	96
23. Carpenter Shop . . . . .	95

LIST OF FIGURES (cont.)

Figure	Page
24. Loft Storage for Purse Seine . . . . .	96
25. Nets and Gear Storage Area . . . . .	97
26. "Gail Ann" Before Conversion . . . . .	100
27. "Gail Ann" Following Initial Modifications . . . . .	100
28. "Gail Ann" Stern Trawling . . . . .	104
29. "Gail Ann" Purse Seining . . . . .	104

## CHAPTER I

### BACKGROUND

The basic concept behind the original proposal leading to the funding of this research program was developed in 1966 as a direct result of the cooperative efforts between the University of Rhode Island, the Point Judith Fishermen's Cooperative, and various Federal and State Government Agencies.

The coordinator of these activities was Dr. Andreas Holmsen, an agricultural economist who had been working with the commercial fishing industry for several years, and had found a need for an education program directed towards the industry and to prepare young men for future positions as fishing skippers.

At that time, the United States fishing industry had declined to the point where the country was importing more fish and fishery products than it was producing. The total catch by all nations fishing in the Northwest Atlantic had increased by 41 percent over the previous six years, while the U.S. catch from the same area had declined 17 percent.

This decline was due to a number of causes, but there is no doubt that one cause was the lack of proper education for those entering the fishing industry. While fisheries colleges existed in many countries, as in Russia, Japan, Poland, Canada, and Chile, technical education for fishermen in the United States was about nonexistent. The United States was sending experts abroad to help establish fisheries institutes, for instance, in Ceylon, while there were none at home.

It was possible for any young man wishing to go into farming, to enter institutions in every state in the nation where he could obtain a good education in farm management or other phases of agriculture. If the same young man wished to enter the fishing industry, he could not obtain an education in this field at any university in the United States, and very few community colleges or vocational technical institutes offered a program that would be of much help to a commercial fisherman.

Before 1965 many ports in the United States, and especially in New England, had been dependent on foreign technical know-how. At that time about 80 percent of the captains, mates and engineers in the Boston trawler

fleet were born and raised in Nova Scotia or Newfoundland. The post-war growth of the fishing industry in New Bedford had, to a large extent, been due to emigration from Norway. Since the average age of the officers on the trawlers was high in many ports, and since the labor market was getting tighter in the countries where the U.S. industry generally had recruited experienced fishermen, it was expected that severe problems would be faced in the near future in finding competent captains for the New England trawler fleet.

With increasing boat sizes, more complicated equipment, increased automation, and considerably greater capital/labor ratio, ability of the captains was becoming more and more important. The trend was towards more corporation-owned boats due to the financing problems with bigger vessels, and knowledge and skill were expected to be of more importance in manning these vessels.

Although the local port of Point Judith had experienced no problems in attracting young people to the industry, the average age of captains in that port was 42 years, and growth in vessel numbers was restricted by a lack of "captain material," despite the good earnings experienced. In interviews conducted by the University to determine whether deckhands or mates had plans for buying vessels, the same answer was received again and again, "too many problems, too many headaches." This showed that they did not possess the knowledge or training to solve the problems which face a captain.

The traditional manner of training meant that fishermen gained their knowledge in a slow and expensive way. The basic training was generally given by the poorer captains in the fleet, and as experience and knowledge were gained by the novice, the better captains were willing to hire him; it took a long time, however, before a man was hired by the best captains in the fleet. The amount of knowledge gained, then, depended on the willingness of the captains to teach (which was often limited) and even under the best conditions, the experience gained at one time was limited to one boat and one kind of gear.

In general, fishermen lacked knowledge of the marketing system with the economics involved, leading to much ill will among the people concerned. Since fishermen through their cooperatives were operating fish processing plants for food fish, fish meal plants, supply stores, etc., a wider general educational background would have prevented many problems.

A need existed, therefore, for suitable educational facilities in the field of commercial fisheries to reduce the training period for fishermen, to educate and train the necessary supply of future captains for the fleet, and to improve the technical and general education level of fishermen.

There being no existing source in the United States able to provide the knowledge and experience in this new educational field, the University took advantage of its existing close working relationship with the fishing industry, and various Federal and State Government agencies, to prepare a program, including a curriculum designed by cooperation between:

- The University of Rhode Island (Colleges of Agriculture\*, Arts and Science, Engineering, Business, and the Graduate School of Oceanography).
- The Point Judith Fishermen's Cooperative (President and Board of Directors).
- The Bureau of Commercial Fisheries (The Technological Lab and the Exploratory Fishing and Gear Research Base, Gloucester, Mass.).

In addition, their efforts received the full support and cooperation of the State of Rhode Island Departments of Education and Natural Resources.

---

\*Now the College of Resource Development

## CHAPTER II

### HISTORY

This chapter is written to provide a general summary of activities, undertaken throughout the project, leading to the development and evaluation of a two year vocational-technical education program in commercial fisheries at the associate degree level. The contents are intended as a guide to the remaining chapters, which provide details of methods, procedures and results of work under the various important headings. It is therefore written in a general manner, with mention being made of actions taken but with only brief background remarks; as appropriate, references are provided to later chapters which give more complete accounts of the various questions raised here.

In total, work of the project extended over six years, with active development being undertaken during the last five years. Due to the length of time involved, it is convenient to divide the activities, for the purpose of this chapter, into the following sections:

Initial Activities: June 17, 1966 - Feb. 6, 1967.  
Preparation for First Students: Feb. 7 - Sept. 19, 1967  
Initial Teaching Activities: Sept. 20, 1967 - Sept. 19, 1968.  
Second Year Activities: Sept. 20, 1968 - Sept. 10, 1969  
Third Year Activities: Sept. 11, 1969 - Sept. 16, 1970  
Fourth Year Activities: Sept. 17, 1970 - Sept. 15, 1971  
Completion of Program Development: Sept. 16, 1971 -  
June 1, 1972

The first section is mainly concerned with the establishment of a suitable administrative base for the project within the University, while section two covers activities, following arrival of the full-time project director, to ensure facilities and teaching programs were ready on arrival of the first student class. The starting dates of remaining sections are arranged to coincide with the beginning of each academic year. During the project it was found that the summer months provided an opportunity to evaluate activities during the preceding academic year and to plan future developments, so that these time divisions follow this natural sequence.

Initial Activities: June 17, 1966 - Feb. 6, 1967

Immediately following the official starting date, the Program Advisory Council, consisting of persons from within the University, the fishing industry, and State and Federal Government agencies, was called together to formulate procedures for implementing the development program (Appendix A). This group met regularly during the period June through December 1966.

It had already been determined that administrative responsibility for the program within the University would rest in the College of Agriculture, so that action was initiated by the college to pass the curriculum, as initially designed with the aid of the cooperating agencies (Chap. I), through the necessary formalities and approval procedures as an Associate Degree curriculum in Commercial Fisheries. This curriculum was approved as designed with minor changes to accommodate alterations in semester course offerings within the university system (Chap. IV).

At this stage, arrangements were begun to establish a new Department of Fisheries and Marine Technology within the University, which would take direct administrative responsibility for the program during its initial development in conjunction with the research proposal, and later as a part of the general program of the University following termination of the Office of Education funding.

Once these actions had been initiated, a search was begun for a permanent project director who would also be appointed chairman of the Department of Fisheries and Marine Technology. The existence of the new program, together with the need for a project director, was made known throughout the United States with the cooperation of the fisheries press, and by personal contact through members of the advisory council within the fishing industry, universities, research establishments, and government agencies. The effectiveness of this publicity may be judged by the fact that more than fifty applications and expressions of interest, both formal and informal, were received for the position of project director within the period June through October 1966.

However, the Advisory Council felt that the type and innovative nature of the program was such that none of the applicants who would actually be able to take the position were entirely suitable, and a person of somewhat different background and qualifications was required.



Dr. Andreas Holmsen was therefore appointed Acting Director of the project and charged with locating a suitable permanent director. Having exhausted possibilities within this country, Dr. Holmsen extended the search into Canada and in November 1966 visited the College of Fisheries, Navigation, Marine Engineering and Electronics in St. John's, Newfoundland. This college had been established in 1964 to operate programs of a similar nature to that proposed, and was the only institution within the North American Continent engaged in activities at an appropriate level. During his visit, Dr. Holmsen received expressions of interest from a number of the faculty there in transferring to Rhode Island to become associated with the new commercial fisheries curriculum.

Following his return to Rhode Island, and after reporting to the Advisory Council, informal contact was established which led to a formal application being received for the position of project director from Dr. John C. Sainsbury, who was at that time head of the Naval Architecture and Shipbuilding Department at the College of Fisheries in St. John's. This resulted in the appointment of Dr. Sainsbury as project director and chairman of the Fisheries and Marine Technology Department at the University of Rhode Island, effective February 6, 1967.

Dr. Holmsen relinquished his duties as Acting Director of the program on that date.

Preparations for First Students: Feb. 7 - Sept. 19, 1967

With the arrival of a permanent project director, preparations began to ensure the program was operational and ready to receive the first students in the fall of 1967.

As a result of the publicity given the start-up of this program, applications were being received at this time from prospective students who would form the first entry in September, and the necessary acceptance procedures continued throughout the summer (Chap. V). To ensure adequate communication with the Office of Admissions, it was considered appropriate at that time to make an appointment to the counselor/evaluator position and Mr. David Mead took up his duties on May 6, 1967.

At this time, due to the lead time involved, staffing was considered of primary importance; existing applications for further teaching positions were reviewed

and additional expressions of interest solicited by the Project Director. These efforts resulted in offers of appointment being made to two men who were at that time on the staff of the College of Fisheries in St. John's, Newfoundland, and who had talked with Dr. Holmsen during his visit. Thus a nucleus of staff having experience in fisheries education would be available for the beginning months of the program.

The first of these positions was in the field of fishing gear and fishing methods, and the second in seamanship and navigation; teaching staff were therefore available to meet the needs of the first semester's work. Mr. David Thomson and Capt. Geoffrey Motte took up their appointments at the end of June 1967.

While these negotiations were in progress, a department office was established in the College of Agriculture building, and a secretary appointed on May 6, 1967.

As a large portion of the teaching work during the first semester of the curriculum involved part-time instructors from other departments and colleges within the University, appropriate communication and class scheduling arrangements were concluded by the beginning of June to facilitate a smooth start to the teaching program following the summer vacation period.

The principal remaining need was to ensure that suitable facilities were available to house the "professional" (seamanship and fishing gear) courses during the first semester. Arrangements were made for classroom space on the main campus for the academic courses, but it became apparent, following a careful examination of possible areas, that a building off campus would be needed to house the laboratories for seamanship and fishing gear, due to requirements for open floor space, room height, and exterior access for handling of gear and setting up nets.

A number of buildings available for rent within reasonable distance of the main campus were examined; ideally, it was hoped that space on the waterfront at Galilee, the adjacent fishing port, could be found. This did not prove possible, however, and the most suitable building found was some two miles from the main campus and adjacent to a federal government establishment in West Kingston, Rhode Island.

Arrangements were made to rent this building on September 1, 1967, as a temporary site for the program laboratories; space was available there for a classroom/drawing room/navigation room, a seamanship/nets and gear laboratory, and an engineering laboratory, so that space requirements for the full first year's operation of the program were satisfied. As the building was "in the middle of a field" and totally divorced from marine facilities and atmosphere, it was considered a temporary measure only.

As occupancy of the building was not possible until September 1, only some three weeks would be available for setting up the laboratories; all necessary equipment and supplies were therefore ordered and stockpiled prior to that date. This work was completed following arrival of the two staff members involved at the end of June.

The one piece of major equipment needed for the first year of the program was a training vessel, and this need became more urgent due to the laboratory facilities being located some twelve miles from the water, so that students needed the vessel contact experience.

Following examination of a number of craft, the most suitable was found to be a 47-foot vessel available for charter from the Graduate School of Oceanography. Considerable modifications to change the vessel from its research vessel role to a fisheries training facility were necessary, and these were begun in July 1967 (Chap. VII).

Following initial outfitting of the laboratories, which was carried out by the program faculty and completed during the first three weeks of September, the first entry of students was received and began classes on September 19, 1967 (Chap. V).

Initial Teaching Activities: Sept. 20, 1967 - Sept. 19, 1968.

When outfitting of laboratories needed for the first semester had been completed, and the varied problems associated with the students beginning a new program had been settled, attention turned to preparation for the second semester's classes timed to begin in early February 1968.

The primary concern, at this stage, was the appointment of an instructor for the marine engineering course to be taught in the second semester; the program

was extremely fortunate in obtaining the services of Mr. James McCauley, one of the "top" skippers from Point Judith, who agreed to accept a six-month appointment while recovering from a back injury. In addition to offering both training and immense practical experience in local fisheries, he brought to the program an excellent communication with the Point Judith fishermen, a vital factor which had been lacking before he took up his appointment on January 1, 1968 (Chaps. III and V).

During the fall semester, equipment and supplies required for the navigation and marine engineering courses were ordered and installed on arrival, much of the engineering equipment being obtained through donations or at nominal cost from manufacturers and local agents. As no technician was available at this stage, all laboratory construction work was carried out by the instructors involved.

A most pressing need became apparent for a technician to service the laboratories and work with the shipyard during the conversion of the training vessel. As it had not proved possible to attract a suitable person for this position, it was necessary to employ several students, during the first semester and part of the second semester, as laboratory assistants responsible for clean-up duties and to assist instructors in the establishment and maintenance of laboratories.

Early in 1968, it proved possible to employ, as technician, another former Point Judith fishing vessel skipper, Mr. Joseph Krawiec, who took up duties at the beginning of April 1968.

An important development during the second semester was the receipt of the training vessel "Gail Ann" from the shipyard, following conversion, at the end of February. After a short period of evaluation and working-up, she was placed in regular use in mid-March, based at Wickford some ten miles from the main campus. The vessel operated on Narragansett Bay on a regular basis three afternoons each week for the remainder of that semester, these sessions proving to be most advantageous in providing a link between the classroom and laboratory work and actual sea-going situations (Chap. VII).

Once these immediate matters of direct importance to the second semester teaching program had been finalized, attention was turned to requirements for the second year's operation due to begin in September.

Two important instructional positions were necessary for the fisheries technology and second navigation courses. Arrangements were made for Dr. Thomas Meade, who was to join the university faculty on July 1, to teach part time in the area of fishery technology. Mr. Robert Merriam, a local electronics engineer, was contracted to provide teaching services in the field of electronic aids to fisheries and navigation. In addition, Mr. James McCauley was appointed to a full-time position in the program to teach fishing operations in addition to his marine engineering responsibility.

Experience during the first year's teaching indicated that additional space would be needed when both first and second year students arrived on campus in the fall. In particular, the engineering and nets and gear laboratories had an urgent need for more space, and a further area for establishment of an electronic aids laboratory was required.

At this time, a building adjacent to the training vessel berth at Wickford became available; as this presented a favorable opportunity to take a first step toward centralizing facilities in a waterfront location, arrangements were made to rent the building with occupancy on June 15, 1968 (Chap. VI).

The seamanship and navigation laboratories were transferred to this new building, and an electronic aids laboratory established during the summer of 1968. In addition, space was available for a classroom, a small area for net work in conjunction with training vessel operations, a student room, and some office space.

The engineering and nets and gear laboratories were expanded in the West Kingston building to meet the needs of the second year courses in these subject areas. In addition, some fishery technology equipment was obtained and placed at West Kingston.

In May 1968 arrangements were begun to place students aboard commercial fishing vessels for their required eight weeks of practical training at sea; with excellent cooperation from both the Point Judith and New Bedford fleets, all students were placed and began their cooperative experience in early June. Further information on the requirements for practical training will be found in Appendix F.

Through the New England Board of Higher Education, the program had been accepted as a "regional program"

so that students from the other New England States could be admitted without payment of the usual out-of-state tuition fees. During the final weeks of 1967 and the early months of 1968, the student counselor visited high schools throughout the region to explain the program and the regional arrangement. Some twenty-five schools were visited, resulting in about sixty-five percent of the applications for the second entry in September 1968.

The student admission's procedure was in progress throughout the year and 23 men formed the second entry in September 1969.

Second Year's Activities: Sept. 20, 1968 - Sept. 10, 1969

The second year's operation of the program began smoothly with 15 students returning to begin second-year classes in addition to the 23 freshmen.

The newly rented and outfitted laboratory building at Wickford was available for use in September, and appropriate classes were transferred to that location, which proved to be effective in providing students with a waterfront atmosphere in which to work.

Considerable difficulty was experienced during the year due to the great distances between the main university campus, the West Kingston building, and the Wickford facility. Despite careful scheduling to ensure students and staff spent a full day at one center wherever possible, considerable time and expense was incurred by them in traveling between locations.

From the beginning, Wickford proved a most satisfactory base of operations for the training vessels, and the advantages inherent in the location pointed-up, to an even greater extent, the rather disappointing atmosphere in which students and staff worked at West Kingston. One of the main objectives during this year was therefore set as the centralization of facilities at the Wickford waterfront site, including the addition of a new building.

Owners of the Wickford Shipyard, where the facility was located, indicated their willingness to construct a building shell to meet the program's requirement for the engineering and nets and gear laboratories to be transferred from West Kingston. The owners were also willing to cooperate further by providing for a long-term lease for all the facilities including vessel

berthing. Negotiations proceeded favorably throughout the year with the intention that the new building would be ready for occupancy prior to the second semester the following year. In the meantime, classes continued at the separate locations throughout the period.

The second major concern during this year was to revise the curriculum. There was general agreement among faculty, students, and local industry people that although many aspects of the program were excellent, others did not meet the needs of students preparing for entry into an industry with rather specific requirements for personnel. In particular, many of the regular university courses taught in other departments and colleges were considered overly academic in nature with little or no relation to the work of the industry (Chap. IV).

Regular meetings of an evaluation group concerned with the program were held throughout the year to assess the need and effectiveness of each course and these led, as a first step, to a revised curriculum being introduced effective with students entering in September 1969 (Chap. IV).

Acquisition of equipment and supplies, to provide students with a well-rounded exposure to that in commercial use, continued; achievement in some areas was greater than in others, but sufficient progress was made to allow necessary rounding out during the later years of the program development. Again, several important items of equipment were donated or made available at nominal cost, especially in the areas of engineering and electronic aids.

Mr. David Thomson resigned from the faculty effective June 30; he was replaced as nets and gear specialist by Mr. Albert Hillier, a well-known skipper from New Bedford, who had previously been teaching a vocational "twine" course for trainees in that port. Mr. Hillier's arrival provided an additional advantage of direct connection between the program and New England's premier fishing port.

Mr. David Mead, the counselor/evaluator, also resigned effective June 30; following a full discussion among those concerned with the program, it was decided that no replacement should be sought for this position, future activities being undertaken in this area by an advisor system and the University Counseling Center (Chap. III).

The summer cooperative experience program continued for the second year, with students aboard vessels sailing from Point Judith and New Bedford.

Nine students, from the original entry of twenty-five, satisfied all requirements and graduated in June 1969 (two completed their work the following year).

It had been planned that the training vessel would be operated during the summers to provide an opportunity for young people to find out whether they "liked the water." Some attempt had been made the previous summer to make such trips available aboard the vessel. In general, however, this was relatively unsuccessful; very few young persons took advantage of the opportunity as many did not want to take the time from jealously guarded summer jobs, or preferred to be at the beach or in a similar occupation. The expense and faculty time involved in operating a vessel for the "one at a time" situations that arose were not felt to be justified.

Following a discussion among the faculty, it was decided to offer a special two-week program during August 1969 that would be open to high school students entering their junior year and above, in order to assess the effectiveness of such an approach in providing a pre-program introduction to the sea and fishing. A program was put together in which students lived on campus in the dormitories to gain a taste of university life, and were introduced to each of the subject areas of the program, together with regularly scheduled sessions aboard the training vessel. Sixteen boys were accepted for the program, which was operated during the last two weeks of August.

Although a number of those enrolled found the program of benefit, only one student later applied to join the program; this, together with the numerous problems involved, was felt to outweigh any small benefit gained by either participants or the program, and it was concluded that it was not worthwhile to repeat the effort in future years (Chap. V).

Preparation continued throughout the summer to receive the third entry of 18 students in September 1969.

Third Year's Activities: Sept. 11, 1969 - Sept. 16, 1970

Sixteen students out of the original 23 of the 1968 entry returned to begin second-year studies.



The low total of 18 freshmen students for the 1969 entering class was the cause of considerable concern, which was deepened by the fact that relatively few of them came from Rhode Island and nearby fishing areas. The counselor had markedly reduced his program of school visits during the previous year, and most of the freshmen had entered as the result of their own efforts in seeking out information after reading of the program in the press.

A particular effort was made during the year, therefore, to set up a program of school visits and acquaint both counselors and students with opportunities provided by the program. This activity was pursued during the closing weeks of 1969 and in the early months of 1970, resulting in a considerable multiplication of applications received during the year; it is reported fully in Chapter V.

This was the first year of operation with the newly revised curriculum, which was found to offer many advantages; at the same time, however, several problems arose. A requirement that students take standard freshman physics courses did not prove very successful, but it was decided to await the results of the following year's classes before making further revisions (Chap. IV).

A further problem was that students were granted credit for their summer cooperative training experience. Although this was felt by faculty, students, and skippers to be a sound educational arrangement, considerable practical difficulties were encountered, and this area was designated for review the following year during the second stage of program revision (Chap. IV).

The year was notable in that facilities were concentrated at one main location during the second semester. The shell of the new building at Wickford was available for occupancy in February and was in use to a limited extent during the spring semester of 1970, the rented building at West Kingston being released at that time. The program office remained at the main campus and the regular academic courses continued to be held at Kingston.

During the summer months, the new building shell was outfitted with an engineering laboratory, nets and gear laboratory, tool room, welding room, carpenter shop, and a nets and gear storage loft; existing equipment was moved in from West Kingston and new equipment obtained to provide a greater range of experience for

students. It is notable that all internal building construction and equipment installation was undertaken by the department staff working with a minimum of outside aid, so saving the considerable expense involved if contractors had been used, and allowing an increased proportion of the available funds to be used for obtaining a greater range of equipment and supplies (Chap. VI).

Mr. Joseph Krawiec, who had been associated with the program for two years, died in early 1970 and was replaced as technician by Mr. Richard Wing.

During July, following twelve months of negotiations, the U.S. Coast Guard authorized a considerably reduced sea-time requirement for graduates wishing to take first license examinations for uninspected vessels. Instead of the normal three years at sea, the requirement was reduced to nine months for graduates of the program. This was reduced further the following year to a six-month sea-time requirement for graduates. This was considered an important achievement and is discussed further in Chapter VIII.

The original program completion date had been set as August 15, 1970; however, a request for a one-year extension was initiated during June, and approved. The main reasons behind this request were: (a) that the first student entry was in September 1967 rather than in 1966 as originally intended, so that only three entries of students had passed through the program instead of four; (b) only one graduating class had entered the industry and accumulated only one year's experience so that insufficient feedback was available; (c) only the first stage of planned curriculum revision had been completed and it was felt that further experience was important to the results of the program development.

Of the 1968 entry of 23 students, 13 graduated in June 1970, and all entered some phase of the fishing or marine industry.

As mentioned previously, the special effort made during the year regarding student recruitment resulted in a considerable rise in the number of students joining in the fall. A total of 29 freshmen made up the fourth entering class in September 1970.

Fourth Year's Activities: Sept. 17, 1970 - Sept. 15, 1971

This year saw continued progress towards development of the program, particularly important activities being the second and final phase of curriculum revision, and the first full year of instruction at the combined Wickford facility.

Fourteen of the previous year's 18 freshmen returned to begin second year classes in September 1970, and found the new building outfitted to provide considerably improved course programs in engineering technology and nets and gear. These facilities were found especially valuable for teaching work during the second-year classes, where professional courses were concentrated following the first phase of the curriculum revision.

Additional construction and equipment were added during the summer of 1971 following this first full year of classes. Again, all work was undertaken by the program staff, with much of the teaching equipment being custom designed and constructed to suit the needs of the courses (Chap. VI).

A second revision of the curriculum was prepared during the first half of 1971, to be effective with students entering the program in September that year. This was the last phase of the revision activities and resulted in the final developed curriculum.

Experience had indicated the need for changes in courses introduced during the previous revision, and these were made in addition to some further alterations of the original curriculum. A complete account of activities and background for the development of the final curriculum is contained in Chapter IV. The principal changes at this time included the introduction of a new course in Fisheries Economics, to replace the existing standard economics course, and the replacement of the standard university physics requirement by a new marine-applied course in physics. Credit requirement for the summer training was removed as a result of practical difficulties experienced in its operation (Chap. IV).

It had become apparent, the previous year, that although the 47-foot craft was ideally suited as a training vessel, it was restricted in its operation during the winter months of the year when required to work outside sheltered water during the final semester

teaching program; also, its size restricted the number of students that could profitably be carried aboard, so increasing the number of sections necessary with the larger intake of freshmen.

This increased number of freshmen students led to greater teaching contact hours being required of instructors, due to the rather small student groups found desirable in a program of this nature, coupled with the physical restriction of the vessel. As this problem was likely to increase the following year, when larger second-year classes could reasonably be expected, an additional instructor was hired in early 1971; Mr. Thomas Stout took up his appointment in February 1971, to teach seamanship and vessel operation.

In order to assess the effectiveness of a larger craft, a 57-foot commercial fishing vessel was chartered for two days a week during the spring semester and found to offer advantages for offshore work. The "Gail Ann" continued in use for courses during the first three semesters of the curriculum.

A program of high school visits and active recruiting was continued during the year and again proved successful in attracting applicants.

During the early summer of 1971, a second extension of the program completion date was requested and approved; this was felt necessary in order to gain experience with the further revised curriculum which was set to apply to the September 1971 entry of students. It was also considered important to have the results of an additional graduating class showing a rather different mix of entering students from previous years (Chap. V).

Eleven of the original 18 students who entered in 1969 graduated in June 1971, all but one entering the industry. Of 70 applicants, 33 students made up the freshman entry in September 1971.

Completion of Program Development: Sept. 16, 1971 - June 1, 1972

This final academic year of the program was used to assess the second phase of curriculum revision. As alterations in the second-year courses were restricted to changes in credit hours for particular subjects, these were applied to the 15 students who returned to complete their work in September 1971. The completely revised first year was applicable to entering freshmen,

so that it was possible to gain experience with both years of the revised curriculum for presentation in this report. A complete account of the curriculum development is contained in Chapter IV; in summary it was found that these final revisions were effective in producing a curriculum containing the work necessary to meet the aims of the program.

During this period, development of course materials was continued, additional equipment and teaching aids being obtained and constructed as necessary to round out the needs of various courses. At this stage, the range of visual and other teaching aids available from industry showed an increasing trend as companies and agencies became more involved in the marine situation and found value in exposing students to equipment and services being accepted for use in the industry. The larger vessel was again chartered for work during the final semester of the program.

A less active recruitment program was pursued during the year, partly as a result of experience with the last two student entries and partly to assess whether the higher number of applicants would continue without such intensive activity.

The final graduating class under the development program consisted of ten students, some of whom will still have an additional requirement to complete in the fall of 1972, but may reasonably be included in a realistic total.

As indicated in the original program proposal, the University of Rhode Island is continuing the program, as developed, and it will form part of the University's regular activities in marine science and technology.

In addition to the direct involvement in development of the fishing industry within the State from the provision of qualified manpower, the presence of the program, together with its staff offering a wide range of skills, has contributed toward the physical development of the industry and the marine related teaching programs and services offered by the University. Chapter IX includes discussion of these important developmental aspects of the program.

## CHAPTER III

### STAFF

The professional fisheries personnel involved in the project is based in the Department of Fisheries and Marine Technology, within the College of Resource Development (formerly the College of Agriculture); these people are responsible for teaching all courses designated as "Fisheries" (Chapter IV) in the curriculum as developed (75 percent of the total credit content), and for student advising.

The general education content of the curriculum (25 percent) is taught by faculty in other departments and colleges of the University as follows:

#### College of Arts and Sciences

Department of Mathematics  
Department of English  
Department of Speech  
Department of Physical Education for Men

#### College of Resource Development

Department of Food and Resource Economics

In addition, the following colleges and departments have provided courses at some stage during the program development:

#### College of Arts and Sciences

Department of Physics

#### College of Business Administration

Department of Management  
Department of Accounting

#### Professional Fisheries Personnel

At the beginning of the project, two faculty positions had been included, together with allowance for a counselor/evaluator post, and a number of part-time teachers for various specialized subjects. However, numbers of sections required for laboratory courses had not been taken into account, and it was found necessary to include additional teaching positions, while the counselor appointment was left vacant after the first two years.

A complete list of all staff involved in the program administration and "fisheries" teaching will be

found in Appendix B, together with curricular vitae for appropriate faculty.

In summary, the following allocation of teaching positions covering the various subject areas was found appropriate:

- 1 position - Project Director, general fisheries, vessel operations, vessel technology
- 1 position - Navigation, seamanship, meteorology, vessel operations
- 1 position - Marine engineering technology, fishing gear, fishing operations
- 1 position - Fishing gear, vessel operations, fishing operations
- 1/4 position - Fish technology
- 1/4 position - Marine electronics and electrical engineering

An additional position approximating a half-time appointment was used during the final year when student numbers increased and it was necessary to provide release time for additional administrative activities.

A more lengthy discussion of the staff requirements, allocation of time, section sizes and student-staff ratio is provided later in this chapter.

#### Personnel in Other Colleges and Departments

In most cases, teachers of the general education and service courses provided by other departments changed from year to year; continuity was maintained through the Department Chairmen.

A notable exception was in the Department of Food and Resource Economics, of which senior personnel taught courses in the earliest years of the program, later developing a five-credit fisheries economics course specifically to suit the needs of this curriculum, and which is taught by a senior person of national standing in the field.

#### Staff Requirements

Commercial fishing is somewhat unique in the number of disciplines involved, each of which is applied in a particular fashion to the work of the industry. Specialties include fishing operations, fishing gear, navigation, seamanship, engineering technology, electronics, fish technology, vessel technology, meteorology, fisheries biology, business, and economics;

the application of each discipline to the fishing industry is a specialized field in itself, and is gradually beginning to be recognized as such in this country.

Teaching needs of the program dictated the availability of specialists in each of the disciplines involved; in some cases it became apparent that a particular person had the capability of teaching in several areas as a result of training and experience, so that a full-time position was indicated; in other cases, a man having the usual training and experience in his specialty was unlikely to have such flexibility, so that a part-time position was indicated.

It was found that although all fishermen have some knowledge in each of the areas, as a necessary background to their operation, they primarily offered expertise in fishing gear and fishing operations, unless having undertaken formal study in a particular area.

Subject areas in which a staff person could undertake a combination of teaching responsibilities were found to be: a) fishing operations, fishing gear, and fishing business, b) seamanship, navigation, and meteorology.

Areas that might be expected to require part-time specialists were found to be: vessel technology, marine electronics, marine engineering technology, economics.

Some overlap in capabilities between the combined areas, calling for full-time staff, and the specialist areas could be expected, depending on individual training and experience. In development of this program, one particular staff member effectively combined teaching in fishing gear, fishing operations and business, and marine engineering technology.

This type of combination becomes more important if very low student numbers are expected, and the converse was found to hold as student numbers increased. In the final years of the program development, it was necessary to use an additional staff member to handle the number of sections in the areas of seamanship and vessel operations, with the increase in freshmen students as reported in Chapter V.

The specialist areas for each teaching position used in the program have been listed previously; data on the persons involved will be found in Appendix B,



and details of the actual courses taught by each are included in the descriptive section on courses in Appendix G.

Student/faculty ratios were found to be dependent on both the number of students it was possible to handle at one time in the laboratory sections, and the number of specialist teachers required. As the minimum faculty needed was found to be governed by the specialist factor, it followed that additional requirements depended on the size of laboratory class section. Depending on the subject area, the number of students it was possible to handle varied from seven at one time aboard the training vessel (governed by the size of the vessel in this case) up to approximately twenty-five in a navigation laboratory.

The high number of student clock hours required by the curriculum, coupled with staff time tables, made it necessary to schedule laboratory classes for several courses concurrently, so that the student group size was often controlled by the maximum number it was possible to place aboard the training vessel. This is considered further in Chapter VII, but it is useful to note here that by a suitable rotation system it proved possible to use sections of ten students for training vessel classes, and hence for the laboratory sections of other courses scheduled concurrently. Details of the actual laboratory section sizes used for various courses in the program will be found in Appendix C.

In the case of courses in which the laboratory classes entailed the attainment of particular levels of skill proficiency by the students, for example, fishing gear and seamanship, it was found that during the first year with freshmen students, a maximum of ten per section was allowable, any additional number making it difficult to spend the necessary time with individual students. It is felt that this number could be extended to twelve or thirteen if some decrease in effectiveness is accepted. It is considered unrealistic to go beyond this number unless a laboratory assistant can be made available.

Discussions among faculty throughout the development of the program indicated that rather than increase the number of students per laboratory section, individual staff members preferred to work an overload of contact hours; this resulted not only from the degree of effectiveness it was possible to attain, but also from safety considerations when freshmen are being introduced to equipment and operations that present

potential danger in inexperienced hands. The actual contact hours and arrangement of laboratory sections and student numbers are included in Appendix C.

If a larger training vessel were used (involving acceptance of increased cost, see Chap. VII), it appears possible to schedule ten students for each session at sea, and by using a rotation arrangement to provide for a total section complement of twelve or thirteen. It is felt, therefore, that after the first semester this number may represent a reasonable goal for the skill development courses in a curriculum of this type, if the accompanying loss of effectiveness is recognized and accepted.

The actual student/faculty ratio for each year during the program development will be found in Table 1. As might be expected, the ratio is low during the earlier years, and is heavily dependent on the number of students serviced. Figures for the mid-years (1969 to 1971) when curriculum changes were taking place cannot be considered particularly meaningful due to the phasing out of certain courses while the new curriculum was being phased in. The table shows equivalent full-time faculty positions for the fisheries staff, and the equivalent instructor time spent by personnel from other departments in teaching the fisheries program students. It should be noted that the additional fisheries faculty time during 1971-72 is due to added administrative and other duties undertaken by the project director during the final year of the program.

The figures have been extended to the following year (1972-73), and these are felt to represent an attainable and reasonable level for this type of program.

TABLE 1  
Student/Faculty Ratio During Program Development

Year	Students	Faculty		Stud/Fac Ratio	
		Fisheries	Other	Fisheries	Total
1967-68	26	3 1/2	3/4	8:1	6:1
1968-69	38	4 1/8	1 1/4	9:1	7:1
1969-70	34	4 3/8	1 1/8	8:1	6:1
1970-71	43	4 5/8	3/4	9:1	8:1
1971-72	48	5	3/4	10:1	8:1
1972-73 (anticipated)	56	4 5/8	3/4	12:1	11:1

- Notes:
1. All staff totals include full-time allowance for program director, who actually allocates half-time to administrative duties.
  2. Counselor/evaluator is not included in these totals, as this position did not involve teaching duties and was later omitted.
  3. Part-time teachers from other departments and colleges are given estimated equivalents of full-time positions per year at the rate of 3 credits for one semester, being considered equivalent to one-eighth full time, following general university practice regarding teaching loads.
  4. Expected student numbers are estimated from an analysis of freshmen applications and second year pre-registrations at the time this report was prepared.

#### The Position of Student Counselor/Evaluator

As noted in Chapter II, an appointment was made to the position of student counselor/evaluator in early 1967; in addition to completing requirements for a master's degree in counseling, the appointee was an ex-Naval aviator who exhibited interest in the students and was active in this work.

The unusual nature of the fishing industry has been mentioned previously, and it became apparent that the appointee experienced considerable difficulty in counseling students and in evaluating their needs and those of the program due to the fact that he did not possess connections within the close-knit fishing community, and was unable to gain their acceptance. It was found that students preferred to approach faculty members experienced in the industry, rather than the counselor, when they were seeking guidance.

Following the resignation of the counselor, a series of discussions among faculty and staff, which included two fishermen, was held. This led to the conclusion that in place of a specific appointment in this area of responsibility, advisory duties so far as the curricular, marine, and fishing industry aspects of the students were concerned should be allocated among the professional faculty having industrial experience; unusual or personal problems of the students falling outside the capabilities of the program staff

members were assigned to the University's Student Counseling Center. This followed the usual advisor system practiced at the University and was found to work most effectively.

Assessment of the program's effectiveness in meeting the needs of students and the industry was assisted by an excellent communication arrangement established through faculty members who continued their participation in the local industry, and by drawing upon the experience of other faculty having previous experience in fisheries education activities. The progress of graduates was watched actively and their comments and evaluations, when coupled with views of the increasing number of fishermen showing interest in the program, proved most helpful. Regular meetings among the faculty, guided by the above activities, were found to offer an effective and continuing means of evaluating the effectiveness of the program, and of developing the curriculum.

#### Qualities, Availability and Recruitment of Faculty

It was found desirable for the full-time faculty involved in teaching activities under the program to have the flexibility to instruct in overlapping subject areas wherever possible. This proved particularly useful where large student numbers were concerned, and when, as happened on several occasions, a faculty member was prevented by illness or other reason from teaching his classes for a time. Such flexibility was found to be particularly important with courses during the freshman year, where large numbers of contact hours in the practical laboratories and introductory courses are found, and also with the courses involving training vessel time.

With a new program of the type being developed, considerable difficulty was experienced during the early stages in finding suitable staff, and it was necessary in the beginning to obtain faculty from Canada. As the number of graduates from this and other programs increases and a number of men continue their education to higher levels, it is to be expected that this situation will become more favorable. Until then, however, the recruitment of faculty is likely to remain difficult, although a number of possible sources did become apparent and are mentioned under the various headings which follow. In general, it is unlikely that people having generally accepted academic qualifications will be found to fill all positions, especially in the more general areas.

The Program Director. This man could be drawn from any of the subject areas, and should be a full-time appointment; it was found most important that the director maintain contact with the student body through the teaching of regular classes throughout the program, and especially with the incoming freshmen students. This provided the necessary contact to overcome problems at an early stage, whereas during the first two years of the program development, when this was not practiced, the lack of regular formal contact was found to be detrimental to student morale and progress. The project director should therefore be qualified to teach at least a phase of an introductory fisheries course.

If the program is associated with an institution where academic qualifications are prominent, then it would appear important that the director be suitably equipped. Such persons from within the practical fisheries field have proved extremely difficult to locate, whereas men qualified in one of the specialist fields with commercial fisheries application experience may be more readily available.

It was found that the program director spent approximately half his time in administrative and student work, and this again points towards a person from one of the specialist areas whose teaching duties would leave the required time.

Fishing Operations, Fishing Gear, Fisheries Business. It was found necessary that instructors in these fields be drawn from the commercial fisheries. Fishing operations and fishing gear are complementary specialist areas in which only commercial fishermen were found to have detailed knowledge needed for instructing potential fishermen. Fisheries business is a specialist field, so that the generally accepted business school courses were not found suitable. For the program it proved possible to obtain the services of extremely experienced owner/skippers, who had been forced to "come ashore" due to health problems, and in one case a person who was also academically qualified; this combination of qualities was found to suit the needs of the program extremely well. Experience indicates that unless a fisherman wishes to come ashore for a particular reason, such as family or health considerations, it would be almost impossible to attract him due to the high earnings prevalent in the industry.

Faculty members qualified to teach in this field might also be capable of handling some teaching

activities in seamanship and practical aspects of fisheries navigation.

Navigation, Seamanship, Meteorology. Experience indicates that this position is exactly suited to a person who has graduated from one of the merchant marine (maritime) academies and progressed to the position of Master at sea. Such a combination of accepted academic credentials and responsible experience enables such a man to adapt rapidly to the needs of the commercial fisherman, and is considered necessary for the faculty member who supervises the training vessels. Inquiries indicated that a number of such men are often available and the academies offer a useful contact in recruiting.

It was apparent that the direction of the training provided by service academies and the experience of line officers differed considerably from that needed in this type of program, so that retired service officers, especially those in the upper ranks, do not appear to offer a source for recruitment.

Specialist Areas. Although each of these areas, which are considered in turn, require instructors qualified in the particular discipline, it has been found even more important that they are highly experienced in the application and practice of those disciplines to the work of the commercial fishing industry; experience indicates that such people are often extremely difficult to locate and attract to teaching because of the high earnings they normally command in industry.

Marine Engineering Technology. This has been taught by two instructors at different stages of the program development, and the difference in background of these men illustrates the desirability of matching particular individuals to the teaching need. For the first three years, the course was taught by a faculty member who was owner and part-time skipper of a "top" trawler in Point Judith; a business graduate with several years engineering education, he had taken a particular interest in fishing vessel engineering, and established the courses in this field. During the past year, he handed over responsibility to a younger man who had pursued an apprenticeship, has experience with a local marine engine distributor, and is also completing a degree in vocational education; his depth of practical knowledge in the field coupled with the academic work provides an ideal background.

A promising potential source of instructors in this field is merchant marine engineer officers who have graduated from a maritime academy, served a number of years at sea, and often wish to take a position ashore for family reasons. Such men are usually well versed in marine engineering practice and have the experience to adapt quickly to the fishing industry applications. Again, graduates of service academies who have been serving officers are considered unlikely to be appropriate.

Marine Electronics, Electrical Engineering. The need is for an instructor to be experienced in the application of electronics to the commercial fisheries, where types and use of equipment differ from that of the services, and this narrows the field of potential candidates. In this program the instructor holds a master's degree, operates a distributorship for fisheries and navigational electronic equipment, and is an acknowledged and trusted expert in the field; he holds a part-time appointment. If such a man can be interested, the background has been found ideal for the position. It is apparent, however, that this type of person is relatively uncommon; a possible alternative may again be found from merchant marine or service personnel, who are prepared to adapt their background to the fishing industry application.

Fisheries Biology. Experienced people are readily available and should be adaptable to the commercial fisheries viewpoint required. Universities, research institutes, and government agencies offer excellent sources for recruitment.

Fishery Technology. As a number of universities offer programs in this area, suitable people are available, although some care may be needed in order to ensure instructors have an interest in the applied fishing aspects. Again, universities, research institutes, and government agencies are useful sources, and it may be possible to attract a candidate from industry, as was the case in this program.

Vessel Technology. This requires a person who not only has formal qualifications in naval architecture and shipbuilding, but is also experienced in fishing vessel design and construction. In most fishing areas, several such people may be available, often practicing designers who fully understand the applications involved, and may be interested in a part-time teaching appointment. People qualified and experienced only in large vessel work should be avoided if possible.

### Technicians

Although most faculty applicable to a program of the type considered may be expected to be skilled in the practical aspects of their field, technician help was found to be essential both during and following the development stage.

Principal activities found appropriate for technician participation were:

1. Construction and modification of facilities
2. Assistance to faculty in setting up laboratories
3. Fabrication of specialized teaching equipment and aids
4. Maintenance of facilities and equipment
5. Maintenance of training vessel

Instructors normally preferred to be responsible for undertaking activities concerned with class work, involving students in setting up, stowage and clean-up duties as an integral part of the program, to establish a natural tendency towards good shipboard habits.

Although not involved in the day-to-day preparation and stowage duties, technicians were called upon, periodically, to assist in certain laboratory classes or demonstrations requiring their expertise or additional assistance.

In order to ensure smooth and reliable operation of classes, and the sometimes sophisticated equipment involved, it was found essential that a high standard of maintenance be established and a technician be on call in order to keep loss of class time due to inoperative equipment to a minimum. This was particularly important with respect to the training vessel.

One technician position was provided for this project and was found sufficient once the facilities were established; however, in the early stages of development for this type of program, it would appear desirable for an additional position to be included due to the large amount of self-fabricated equipment and unusual facilities involved.

### Secretarial Positions

The separation of waterfront facilities, which are needed for the program, from the main university campus



led to the necessity of maintaining an office in both locations in order to ensure adequate communication with the support facilities of the main organization (Chap. VI). During the development stage, with the associated administrative work involved, it was found important that the secretary be based at the main campus.

At the same time, however, the faculty based at the waterfront did not have direct access to the secretary, and this led to considerable difficulty and delay in the handling of the large amount of instructor-prepared teaching material needed as a result of the novel nature of the program.

## CHAPTER IV

### CURRICULUM

As noted in Chapter I, the existing manner of training fishermen was through practical "on the job" experience aboard fishing vessels, which had been found an overly lengthy and relatively inefficient procedure, advancement even for young men with good potential often being a slow, lengthy and uncertain process.

The principal aims of the curriculum were therefore to reduce the training period for fishermen, to educate and train the necessary supply of future captains for the fishing fleets, and to improve the technical and general education level of the fishermen.

Due to the structure of the industry, it was assumed that graduates of the program would normally first gain employment aboard a fishing vessel at the deckhand or equivalent level, advancement depending on their individual performance. It could be expected, however, that the time scale for advancement would be considerably reduced compared with young men who entered the industry without passing through the program. At the same time, some graduates having previous fishing experience might be expected to assume command or become owner/skippers on completing the program. As can be seen from Chapter V, and Appendix D which lists the positions taken by graduates, this assumption was found to be correct.

The direct goals of the curriculum were therefore established as:

1. To provide students with the knowledge and skills necessary to gain employment in the fishing industry as crew members aboard all types of fishing vessels.
2. To provide the background and theoretical knowledge required by fishing vessel skippers and owner/skippers.
3. To increase the general education level of students.

It was realized that some graduates might find themselves unsuited for work at sea, wish to gain employment ashore or in an associated marine industry, or be forced to come ashore for health or other reasons. A secondary goal was therefore to provide students with a background in associated and supporting sectors of the industry.

Development of the curriculum to meet these goals was a continuous activity throughout the project, starting in 1967 with a course layout designed in cooperation with the fishing industry and government establishments. Major revisions were undertaken at two-year intervals, in 1969 and 1971; minor changes were introduced on a trial basis in intervening years as found necessary.

The first step when undertaking each major revision was to examine the curriculum layout and content of individual courses. This layout was expected to show a blending of the required subject areas, taken to appropriate levels, in order to produce a cohesive pattern of work leading to the established goals. Individual courses were expected to provide the appropriate subject matter together with its specific application to the skills and technical background needed in each field. The results of this examination showed where modifications were needed; this was followed by the establishment of proposed changes, including alterations in course content and emphasis considered necessary to make the program a cohesive entity. Finally, the proposed changes were passed through the established lines of discussion and approval within the University in order to qualify for award of an Associate Degree.

#### Procedure for Major Curriculum Revisions

In practice it was found that activities for the evaluation and proposed changes overlapped to a large extent, so that a common method could be used. The method chosen to undertake the evaluation and formulation of proposals was the use of a committee representative of the industries served, people having previous experience in commercial fisheries education, and the program staff.

At times when major revisions were in preparation, the workload for the committee was heavy, meetings extending over several hours normally being held weekly for a period of between three and four months. At other times, meetings were held at approximately monthly intervals.

It was considered unrealistic to expect commercial fishermen and other industry people to work regularly in these activities, as they would have experienced considerable loss of earnings due to the time spent away from their business operations. Full use was made, therefore, of faculty who had been recruited directly

from industry positions; their knowledge of both the needs of industry and practical teaching made them especially valuable in relating the work of the program to the established goals. In this way, a fully representative committee was set up, which was able to commit the necessary time without sacrificing earnings from commercial activities.

Full time committee membership included:

- The project director, as chairman.
- Two experienced fishing vessel owner/skippers, representative of New England fisheries.
- Professional fisheries faculty.
- A fisheries technologist, formerly an industrial research and development director.
- An operator of a marine electronics company serving the fishing industry.
- A fisheries extension agent.
- An experienced merchant marine shipmaster.

Contact with industry, to obtain direct input, was maintained through the natural association of the vessel owners/skippers on the faculty, the fisheries extension agent, and specialist faculty in their appropriate areas. This arrangement proved extremely effective in two-way communication and representation of the various sectors without the need to ask for their regular attendance.

As appropriate, faculty members from the other departments, whose courses were used in the curriculum, together with other interested faculty, were invited to formal meetings; as in the case of the industry input, however, it was found most satisfactory to undertake most of the consultations between formal meetings so that the results and opinions were available for discussion at those meetings. This method of working avoided difficulties of scheduling committee meetings among so many people, particularly as they were held at the waterfront facility, some ten miles from the main campus.

Input from students was gained both by the use of informal group discussion and through formal meetings between the project director, faculty and the student body. The experience of graduates working in the industry was considered most important; various faculty members followed up the work and progress of individual

graduates to obtain their input.

Where the evaluation committee found that courses in the various fields did not blend to form a continuous progression towards the goals, or where the course content was not found appropriate to commercial fisheries application, various alternative actions were considered, including the dropping of courses, the addition of new courses or changes in the existing course content. Courses found inapplicable to the program goals were dropped; new courses were added to fill gaps in important subject areas, and existing courses were changed where the emphasis or level of work was considered inappropriate.

Curriculum and course changes resulting from these findings were then passed through the routine curriculum procedure within the University. The first step was approval by the faculty of the Department of Fisheries and Marine Technology; this was followed by submission to the Curriculum Committee of the College of Resource Development before consideration and approval by the College Faculty. From this point, the proposals were placed before the Curricular Affairs Committee of the Faculty Senate, and upon clearing discussion at that level were considered and approved by the Faculty Senate, the final step.

It was the responsibility of the project director to carry the proposals through the university procedure, other faculty becoming involved if needed for discussion of their particular area. The process was extremely thorough, lengthy and time consuming, so that in as many cases as possible, experience was gained with changes before they were made into formal proposals, in the interest of efficiency.

#### Procedure for Minor Changes

Between major revisions, in cases where existing courses were found completely unrelated to the program goals, or where an urgent need for coverage of a new subject area existed, necessary minor changes were made immediately on an experimental basis, and were then considered fully in the following major revision. Implementation of such changes was handled by the project director in consultation with the program's Curriculum Evaluation Committee and the faculty involved. Under this heading might be included such items as the substitution of a new course for one found unsatisfactory at the first offering, or change in course content. Once new courses had been passed through the university

approval procedure, they were substituted through a procedure in which students petitioned their acceptance in place of the formally required course.

This combination of major revisions with the simpler procedures involved for minor changes proved a most satisfactory means of developing the final curriculum.

#### Development of Final Curriculum

The initial curriculum used for students entering the program in September 1967 and September 1968 is shown in Table 2. It had been designed by the various interested colleges of the University, the President and the Board of Directors of the Fishermen's Cooperative at Point Judith, Rhode Island, and the Bureau of Commercial Fisheries Laboratories at Gloucester, Massachusetts.

Of the 72 credits required, 44 were in the professional fisheries field, the remaining 28 falling under a general education heading, although chosen with the intent of providing a background in the various areas of importance. Course outlines for the initial curriculum are included in Appendix E.

After the first full year of experience with the curriculum, several important problem areas had been identified, which may be stated generally as:

- No direct goals for the curriculum had been established; it included a number of courses in the professional fisheries field, without following a path leading to any goal other than providing a general education with emphasis on subjects useful to a commercial fisherman.
- Many of the background courses were introductory in nature, with virtually no application to the commercial fishing industry or work of a commercial fisherman whose specific utilization of the subject matter represented a specialization not mentioned in the courses.
- Insufficient time had been allotted to the professional work, if students were to achieve any degree of practical proficiency in their profession.

It was apparent, therefore, that if the program was to reach its general aims, considerable modification of

TABLE 2 - ORIGINAL CURRICULUM (1967)

This course layout applied to students entering the program in September 1967 and September 1968.

FIRST YEAR

First Semester		Credits
ENG 1	Composition	3
FISH 1	Seamanship	3
FISH 2	Fishing Gear I	5
MATH 9	Algebra and Trigonometry	3
MGT 10	Introduction to Business	3
PH.ED. 60M	First Aid	1
		<u>18</u>
Second Semester		
F&R ECON 5	Econ. of Food Production	3
FISH 5	Marine Engineering I	4
FISH 7	Navigation I	4
FISH 9	Biology and Conservation	3
PHY 14	General Physics	5
		<u>19</u>

SECOND YEAR

First Semester		
ACCT 5	Accounting Principles	3
FISH 3	Fishing Gear II	3
FISH 6	Marine Engineering II	4
FISH 8	Navigation II	3
FISH 10	Vessel Construction & Appraisal	3
FISH 11	Fishery Technology	3
		<u>19</u>
Second Semester		
FISH 4	Fishing Gear III	4
FISH 12	Fishery Hydrography	4
FISH 20	Fisheries Problems	1
F&R ECON 40	Marketing of Food Products	3
MGT 103	Personnel & Industrial Relations	3
SPE 1	Fundamentals of Speech	3
		<u>18</u>

(Plus 8 weeks on-the-job training between 1st and 2nd school years)

the original course layout and content would be necessary. (Experiences of the first graduates on entering industry confirmed these problems.)

Before initiating any major changes, however, it was necessary to establish direct goals for the curriculum; this was the first task of the Curriculum Evaluation Committee and resulted in the set of goals reported earlier in this chapter.

It was then possible to determine the general form the curriculum should take in order to reach the goals set, and this was summarized as follows:

1. The first year to emphasize preparation of students in an introduction to the work and background of commercial fisheries, general education courses, and basic development of practical commercial fisheries skills.
2. The second year to consist entirely of professional commercial fisheries courses covering the various important fields, and including a course where all the areas are applied to an actual commercial fishing operation.
3. The general education content should amount to one-quarter of the total credit requirement in order that the curriculum qualify for an award of an Associate Degree. This was a standard University requirement, and it was considered important to follow such procedures where they did not obviously conflict with the program goals.

The next step was to set out the various subject areas of importance in preparing students to enter the fishing industry, together with the knowledge needed to provide them with "skipper potential." It was important (referring to the goals) that the subject areas should include a significant content of fields having application to both the commercial fishing and associated industries. The following subject areas were established:

1. Basic mathematics and physical principles.
2. Communication, both written and oral.
3. First aid.
4. General fisheries - an introduction to fisheries biology, and to commercial fishing operations.



5. Vessel operations - experience with all types of vessel operated fishing methods.
6. Seamanship.
7. Fishing gear - general twinework, principles of construction and operation for all types of fishing gear.
8. Navigation - chartwork, electronic aids, celestial.
9. Meteorology.
10. Marine engineering technology - diesel engines, general systems.
11. Fisheries economics.
12. Fisheries business.
13. Marine electronics - basic electrical engineering, aids to navigation and fishing.
14. Fish technology - storage, preservation, industrial.
15. Vessel technology.
16. Commercial fishing operations.

A comparison of the initial curriculum layout with the established form and subject area requirements indicated that considerable modification would be required. It was considered desirable, therefore, to undertake the modification in two stages; in this way it was possible to evaluate results of changes made at the first revision and incorporate additional modifications found necessary during the second major revision.

The general form of the two stages for revision was established as:

#### First Revision

- a. Place principal professional fisheries courses in second year.
- b. Remove most courses found ineffective in application to the commercial fisheries.
- c. Add or change courses to provide the introductory and applied fishing activities.

#### Second Revision

- a. Modify results of first revision as found necessary.
- b. Complete process of removing courses found ineffective and replacing them with fisheries courses.

At the same time, it was considered desirable to reduce the total credit requirement from 74 to 72, due to a general feeling among the faculty that the large number of clock hours spent in the laboratory and workshop, in sea-time aboard the training vessel, and

report writing left the students with insufficient time for preparation and assignments.

### The First Major Revision

The revised curriculum, as established for students entering in September 1969, is presented in Table 3, and shows the concentration of professional fisheries courses in the second year; the first year is directed to preparatory work necessary to undertake the second year courses, introductory fisheries knowledge, and some skill development courses.

The reasoning and actions taken are outlined in the following sections:

General Education Courses. Content of the following courses was found to be of an introductory nature having no relation to either the background or work of the commercial fisheries. They were therefore dropped:

- MGT 10 - Introduction to Business
- ACCT 5 - Accounting Principles
- MGT 103 - Personnel and Industrial Relations
- F&R ECON 40 - Marketing of Food Products

Although F&R ECON 5 was considered only partially effective, it was retained for the first revision, a separate section being provided for the program's students in which the instructor would emphasize both production and marketing economics using some fisheries examples. It was the intent that a completely new fisheries economics course would be introduced during the second major revision.

It was apparent from the students' performance that the original physics course was over concentrated. As a trial measure, therefore, the standard physics freshman courses, involving three additional credits, were included in place of the existing five-credit course, this to be reviewed following a single year's experience with use of the arrangement.

In accordance with the decision to place all general education subjects in the first year, the three-credit speech course was transferred to the second semester.

Fisheries Courses. Those fisheries courses built upon the general and skill development subject areas of the first year were placed in the second year of the curriculum layout; included were new courses to ensure

TABLE 3 - CURRICULUM FOLLOWING FIRST MAJOR REVISION

This course layout applied to students entering in September 1969 and September 1970.

FIRST YEAR

First Semester		Credits
ENG 1	Composition	3
FISH 13	Shipboard Work I	1
FISH 18	Intro. to Commercial Fisheries	4
MTH 9	Algebra and Trigonometry	3
PH.ED. 72	First Aid	1
PHY 1	General Physics	4
		<u>16</u>
Second Semester		
FISH 14	Shipboard Work II	1
FISH 21 (2)*	Fishing Gear I	3
FISH 31 (1)	Seamanship	3
F&R ECON 5	Econ. of Food Production	3
PHY 2	General Physics	4
SPE 1	Fund. of Oral Communication	3
		<u>17</u>
Summer between 1st and 2nd years		
FISH 19	Industrial Practicum	5

SECOND YEAR

First Semester		
FISH 15	Shipboard Work III	1
FISH 35	Fisheries Meteorology	1
FISH 41 (5)	Marine Engineering Technology I	4
FISH 51 (11)	Fish Technology	4
FISH 61	Marine Electronics	3
FISH 81 (7)	Navigation I	4
		<u>17</u>
Second Semester		
FISH 22 (4)	Fishing Gear II	3
FISH 42 (6)	Marine Engineering Technology II	4
FISH 71 (10)	Vessel Technology	3
FISH 82 (8)	Navigation II	3
FISH 92	Fishing Operations	4
		<u>17</u>
Total credits required - 72		

\*Many courses renumbered -- old numbers shown in ( )

coverage of the subject areas established, with a course on Fishing Operations designed to bring together the various professional subjects in their application to the work of a fishing vessel skipper.

In the original curriculum, no specific time had been allocated to on-board vessel work; a new sequence of three one-credit courses on Shipboard Work was included to provide practical skills in the operation of vessels and the principal fishing methods.

To provide the introductory work required, a new course was introduced covering both the subject matter previously included in Fisheries Biology, together with commercial fishing methods and fishing gear.

Other fisheries courses dropped were Fisheries Hydrography (the work now being included under Fishing Operations), and one course in the Fishing Gear sequence (where a more efficient allocation of the total fishing gear content of the curriculum was achieved through distribution of the material among two formal Fishing Gear courses, the first Shipboard Work course, and the Fishing Operations course).

A most important addition was the inclusion of a five-credit Industrial Practicum course to provide formal credit for the two-month shipboard training period, which had previously been a non-credit requirement. This action reflected the importance placed on this aspect by the Curriculum Evaluation Committee.

The new course in Marine Electronics was introduced as a minor change for the second student entry in place of Personnel and Industrial Relations, which had proved completely unsuitable on its first showing. The experience gained in this way proved the effectiveness of making minor trial changes in this manner, and confirmed the value of the new course.

Complete course outlines for the curriculum following the first major revision are included in Appendix E.

#### Experience with the Curriculum Following First Major Revision

In general the revised curriculum was found to provide a more sequential, cohesive and complete coverage of the required subject areas than that used previously. Two problem areas were identified, however: the physics requirement, and the industrial

practicum cooperative education experience.

Physics. It was noted in the previous section that the standard freshman series of two physics courses was introduced as a trial measure. The first year's experience (with the 1969 entry of students) was not encouraging, only three of the students passed the first course in the fall semester, although several more students were able to pass at a second attempt during the spring semester. Investigation indicated that students were combined with the regular freshman physics classes on campus, with large numbers being in class at one time (approximately 250 students a session), the purely classical approach followed, and the complete lack of problem application to the marine field. Although not indicated by the outline, about one-half of the second course was in practice devoted to modern physics.

In order to confirm that the courses rather than the particular group of students were responsible for the poor results in this particular type of curriculum, the physics requirement was left unchanged for the first semester of the following year, to be dealt with as a minor change should the need arise. The experience was repeated so that it was decided to make available a course taught within the Fisheries Department as an alternative; this course, Marine Technology, is described under the second major revision heading, and was offered during the spring semester in 1970 on a trial basis before being included under the final curriculum. To avoid undue penalty on students for what was considered an error of judgment, the "minor change" procedure was adopted to accept satisfactory completion of either one Physics course or Marine Technology as meeting the program requirement. Students were permitted to offer equivalent credits in subjects of their own choosing to reach the total credit requirement for graduation.

Industrial Practicum (Summer Cooperative Education Experience). The second problem, which was entirely unexpected, arose in connection with granting credit for this requirement. During the first two years of the program, the two months at sea experience had been a requirement without earned credit, and had proceeded smoothly, being considered of great benefit by students, faculty, and the industry. As noted previously, the practical commercial fishing experience was felt to be of such value by the Curriculum Evaluation Committee that it should carry formal credit. However, the year 1970 in which the formal credit requirement

was first introduced coincided with the general decline in the country's economy, which not only was reflected by the fishing industry but meant that many skippers and owners who had previously accepted students for summer training were then hiring relatives or friends, displaced from other employment, and could not take the students.

Following considerable effort, it proved possible to place all the students for at least a portion of the necessary time, but the requirements had to be modified to take account of the situation.

Several problems arose as a direct result of granting credit for the experience instead of simply making it a requirement:

- For administrative purposes, the course was placed under the University Summer School Program; its length did not coincide with standard summer school terms, leading to problems with reporting and official grading.
- Students were required to pay relatively high summer school fees although no university facilities were used, and as expressed on one occasion, "We pay to work our hearts out."
- One student was placed aboard two different vessels; on each occasion the skipper refused to keep him aboard for more than a few days, and it proved impossible to arrange a further placement. This led to a claim that he had not been provided the opportunity to undertake the required work for credit, and resulted in considerable difficulty regarding return of fees paid. The situation was finally resolved by allowing him to make his own arrangements to repeat the course during the following summer in order to gain the required credits.
- Insurance for students while on board commercial vessels led to some difficulty; if the student was employed as a crew member, then he was included in the vessel's liability coverage; however, in cases where the owners placed him on board as an extra hand, insurance was not included.

These problems were sufficient to call for reconsideration of the allocation of credit to the summer cooperative education experience. The problems have

been outlined at some length to indicate the types of unexpected difficulties that can arise due to the unusual arrangements common in the commercial fishing industry.

As problems had arisen in three areas, the University administrative arrangements, placement in the industry, and student attitude, and as discussions indicated that none of these problem areas was likely to be resolved before the following year, the requirement was dropped for the 1970 entry, students being allowed to substitute other credits to meet the total requirement for graduation.

A complete description of the procedures involved in placement and performance evaluation for the summer cooperative education experience is contained in Appendix F.

#### The Second Major Revision

This revision produced the curriculum as finally developed, and was effective with students entering in September 1971 (Table 4). In order to gain experience with changes applicable to some of the second year courses, the modified arrangements were offered during the 1971-72 academic year, and applied to the 1970 student entry as minor changes. The principal changes made were:

Removal of FIS 019 - Industrial Practicum. Difficulty in placement, together with the problems outlined previously, indicated the need to re-examine arrangements for the course. A poll of the 1970 student entry indicated that approximately 95 percent had arranged, or intended to arrange, employment in some phase of the marine industry for the summer; it was decided, therefore, to remove the formal course requirement, but to note that students are expected to work in some sector of the fishing or marine industry during the summer vacation between the two academic years.

This arrangement appears to be working satisfactorily, the majority of students in the 1970 entry having engaged in suitable employment, and most of the 1971 entry having initiated such arrangements at the time of writing.

Replacement of Physics 111 and 112 by FIS 110 - Marine Technology (a new course). It was considered that students would show greater motivation and receive

TABLE 4 - FINAL DEVELOPED CURRICULUM

This course layout applied for the first time to students entering in September 1971.

FIRST YEAR

First Semester			Credits
ENG 113 (1)*	Composition		3
FIS 013 (13)	Shipboard Work I		2
FIS 118 (18)	Intro. to Commercial Fisheries		4
MTH 109A (9)	Algebra and Trigonometry		3
PEM 172 (72)	First Aid		1
REN 135	Fisheries Economics		5
			<u>18</u>
Second Semester			
FIS 014 (14)	Shipboard Work II		1
FIS 110	Marine Technology		5
FIS 121 (21)	Fishing Gear I		3
FIS 131 (31)	Seamanship		3
SPE 101 (1)	Fund. of Oral Communication		3
-	General Education Elective		3
			<u>18</u>

SECOND YEAR

First Semester			
FIS 015 (15)	Shipboard Work III		1
FIS 135 (35)	Fisheries Meteorology		2
FIS 141 (41)	Marine Engineering Tech. I		4
FIS 151 (51)	Fish Technology		4
FIS 161 (61)	Marine Electronics		3
FIS 181 (81)	Navigation I		4
			<u>18</u>
Second Semester			
FIS 122 (22)	Fishing Gear II		3
FIS 142 (42)	Marine Engineering Tech. II		4
FIS 171 (71)	Vessel Technology		4
FIS 182 (82)	Navigation II		3
FIS 192 (92)	Fishing Operations		4
			<u>18</u>
Total credits required - 72			

\*Many courses renumbered -- old numbers shown in ( ).

Note: Students are expected to work in some sector of the fishing or marine industry during the summer vacation between the two academic years.



greater benefit from an applied marine consideration of basic physical principles, rather than the classical approach used in the standard freshman physics courses. A new five-credit course, emphasizing the basic principles of physics needed by students in this type of program, was therefore established with application to marine and fisheries activities. As noted previously, it was offered on a trial basis in the spring of 1971, proving to meet the needs, before being made a part of the final curriculum.

Replacement of F&R ECON 105 (formerly F&R ECON 5) by REN 135 - Fisheries Economics (a new course). At the time of the first major revision this change had been anticipated. Discussions between the Curriculum Evaluation Committee and the Department of Resource Economics resulted in this more extensive five-credit economics course formulated to meet the program needs.

Addition of a Three-Credit Free Elective. This was included to bring the general education courses to the required 25 percent of total credits; it permits students to elect a course to suit individual wishes and has been well received by the 1971 entry.

Addition of Credits to Fisheries Courses. An additional credit was added to three existing fisheries courses in areas where additional emphasis had been found desirable. One credit added to FIS 171 (formerly FIS 71) Vessel Technology, to include a laboratory session. One credit added to FIS 013 - Shipboard Work I, to provide a more reasonable allocation of credit for a six-hour laboratory course. One credit added to FIS 135 (formerly FIS 35) to allow increased depth of topic coverage and additional application to practical vessel operation.

#### The Final Curriculum

Course layout for the curriculum as finally developed is presented in Table 4. It should be noted in reading this curriculum that a general change in course numbering had occurred throughout the University between the times of first and second major revision; new course numbers are used in Table 4, the old number being shown in parentheses following the new numbers, in order to assist in cross reference with the earlier curriculum layouts of Tables 2 and 3.

All students entering the program in September 1971 passed through the revised first year; the new second year course layout and content were applied to students

beginning their final year at that time. In this way it was possible to gain experience with all the changes during the one remaining year of the project. No further revisions in curriculum layout or content were found necessary.

### Subject Outlines

Subject outlines are included under course headings in this section for the curriculum as finally developed. A complete description of each course, including subject outline, weekly lecture and laboratory schedules, texts, aids, equipment, instructors method of working, grading, and other pertinent information forms Appendix G. Typical examination papers, which indicate the level and standard reached in each course, are included in Appendix H.

### General Education Subjects

English 113 Composition -- Emphasizes correctness in writing and clear presentation of ideas. Reading exercises in exposition, and composition of essays.

Math 109A Algebra and Trigonometry -- Basic principles of algebraic logarithmic, and trigonometric calculations with applications to problems related to navigation; preparation for navigation.

Physical Education 172 First Aid -- Basic instruction and practice in accident prevention and first aid procedure. Students successfully meeting requirements will receive a Standard First Aid Certificate.

Resource Economics 135 Fisheries Economics -- Analysis of supply and demand for fish and fishery products. Cost and return in harvesting and processing. Crew remuneration systems. Fisheries policy and management.

Speech 101 Fundamentals of Oral Communication -- Development and integration of skills and attitudes essential to effective and responsible participation in typical communication situations. Emphasis on clear diction, proper use of voice, reading aloud, and the fundamentals of speech organization and presentation.

### Fisheries Subjects

013 Shipboard Work I -- Work aboard training vessels in port and at sea. Experience is gained in operating vessels, their equipment and principal methods of fishing.

014 Shipboard Work II -- Work aboard training vessels at sea and in port. Experience gained in rigging and working common gear used in the commercial fishing industry.

015 Shipboard Work III -- Work aboard training vessels at sea and in port. Rigging, working and evaluation of fishing gear.

110 Marine Technology -- Application of basic physical principles of statics, dynamics, heat, light, sound, and electricity to problems encountered in vessel operation, fishing gear, navigation, fish finding, handling and storage of fish, engineering and electrical systems.

118 Introduction to Commercial Fisheries -- Commercial fisheries of the world, the United States and New England, including fishing grounds, resources, catch statistics and legislation. Introduction to fisheries biology with emphasis on the natural history of important commercial species and the food chain. Effect of fishing pressure and introduction to management of fishery resources. Utilization and principal catching methods for the various important commercial species, including vessels and gear.

121 Fishing Gear I -- Detailed study of bottom and mid-water trawls and other dragging gear. Emphasis on construction, repair and use of different rigs and net designs, including the seine net.

122 Fishing Gear II -- Detailed study of the purse seine, gillnet, trap and longline. Emphasis on the construction, repair and use of the various arrangements and designs of each. Brief treatments of other fishing methods.

131 Seamanship -- Basic shipboard terminology and orientation. Safety at sea. Characteristics and use of rope and wire, tackles, gear systems, stress factors. Shipboard maintenance. Ship handling. International rules of the road. Knots, bends, hitches, rope and wire splicing.

135 Fisheries Meteorology -- Basic practical meteorology and weather forecasting for the mariner. The atmosphere, heat budget of the earth, hydrometeors. Fundamental pressure systems, air masses, formation of fronts and associated weather. Precursory signs, tracks and vessel conduct for tropical revolving storms. Ice, icebergs and icing-up conditions. World Meteorological

organization, coding and decoding of weather reports.

141 Marine Engineering Technology I -- Diesel engine operation, maintenance, testing, timing and overhaul. Basic principles of diesel designs in common use, including fuel systems, combustion chambers, piston and liner assemblies, camshafts and crankshafts, cooling systems, and lubrication systems.

142 Marine Engineering Technology II -- Introduction to hydraulics, including operation, maintenance, troubleshooting, installation, and applications. Study of basic hydraulic systems, design of common hydraulic components, and selection of components for various applications. Study and application of mechanical and hydraulic diesel powered drive units. Layout and uses of shipboard water pumps.

151 Fish Technology -- Introduction to microbiology and biochemistry as they relate to spoilage of fish. Preservation and processing methods at sea and ashore. Plant sanitation and quality control. Processing of industrial fish.

161 Marine Electronics -- Basic electricity applied to fishing. Basic solid state vacuum tube electronics. DC and AC machinery, ship wiring, communications, depth and fish finders, radar, electronic navigation systems. Noise control, siting and preventive maintenance of equipment.

171 Vessel Technology -- Flotation principles, the lines plan, detailed treatment of stability, use of hydrostatic and stability information. Powering, propeller selection. Construction in wood, steel, ferro concrete and GRP. Introduction to vessel economics leading to choice of size and particulars.

181 Navigation I -- Fundamental rules and methods of chartwork. Chart projections and types. Position fixing, wind and tide allowance. Variation, deviation and compass error. Principle of transferred position line and doubling angle on the bow. Use of sextant angles, radar, hyperbolic, and celestial position lines for chartwork. Tidal theories and calculations involving parallel, plane and mercator sailings.

182 Navigation II -- Continuation of Navigation I. Basic astronomy applied to celestial navigation. Study of time and the solar system. Azimuth, amplitude, pole star and meridian altitude problems. Sight reduction by calculation, short method tables and inspection.

Use of information from electronic aids to navigation.

192 Fishing Operations -- Principles of fishing vessel operation. Year-round, seasonal, trip, daily planning and work. Working the New England grounds for principal commercial species, including correct rigging of gear and fishing procedures. Fishing vessel management and business procedures.

## CHAPTER V

### STUDENTS

The program received its first entry of students in September 1967; since that date four entering classes have completed the two-year curriculum and a fifth class has been entered which will complete work in June 1973. A total of 96 students have entered in the four classes, of which 47 (49% of those entering) are graduates or will complete graduation requirements within the next year. Most graduates have found employment in some sector of commercial fisheries or associated marine industries upon graduation; the remainder have elected to continue their college education (in many cases supported by funds from a part-time fishing operation).

Of the 129 students who have started the program during the five years (including 33 freshmen who entered in 1971), 59 have come from Rhode Island, 40 from other New England states, 18 from other areas of the United States, 1 from Kuwait, and 1 from Colombia.

In 1967, the program was designated as regional in nature under the cooperative plan of the New England Board of Higher Education; under this plan, students from other New England states are accepted on the same terms as Rhode Island residents, and are not required to pay the additional non-resident tuition fee. The high proportion of students from the other New England states who have entered the program must be attributed largely to this plan.

#### Admission

The handling of applications and admissions for students entering the program has been the responsibility of the University's Dean of Admissions.

In general, candidates for admission had to meet the requirements for all students applying to the College of Resource Development (formerly the College of Agriculture), but they were judged also on their aptitude, interest, and background (in terms of their commercial fishing interest).

The stated requirements for all applicants included:

1. Sixteen units of college preparatory work, including 4 units of English, 2 units of Algebra and Plane Geometry, 1 unit of

Physics or Natural Science, 1 unit of History or Social Science, and 8 additional units.

2. Completion of the Scholastic Aptitude Test, the English Composition Achievement Test, and at least two other achievement tests administered by the College Entrance Examination Board.
3. Completion of the standard Admission's Questionnaire in which the student was able to explain his interests and any previous background in the field.

The Admissions Office found that the applicants for this program mirrored in smaller scale the applicant pool for the University's entire freshman class, in that a wide range of talents and achievements was reflected in the total candidate group, which included some superior students, many average to fair students, and others ranging down in terms of academic performance in their preparatory experience.

In making admission decisions, some orientation of interest to a fisheries career was assumed on the part of strong or average students, and these were accepted promptly. The background of the remaining applicants was then re-examined to identify those with a strong motivational interest in the fisheries industry. Such factors as work experience in fisheries or related industry, and family association with fisheries were weighed in the assessment of these applicants. In some cases this assessment could be made from the Questionnaire, and in others the candidate was asked to the campus for interview, which normally included talks with both an admissions office counselor and the program director. During each year of the program, a substantial number of students have been admitted on the basis of the weighted appraisal. As might be expected, this was more noticeable during the earlier years of the program, but as the applicant group grew during the last two years, it became of rather less importance.

It was apparent that many applicants having considerable fishing experience, especially sons of fishermen, did not test well or show adequate preparatory achievement due, in many cases, to a lack of recognition that a high school education was of importance, or because they did not consider it relevant. Despite this, such applicants could be expected to enter the industry due to their close association and obvious desire, so that

every effort was made to accept these students in order to provide them with additional background, although they might not be expected to graduate. Additional discussion of this point is included under the Criteria for Graduation section later in this chapter.

Basic statistical information regarding admissions is given in Table 5. The number of applicants in the early years was relatively constant, falling in 1969 but rising in 1970 and 1971; this was considered due directly to the efforts made by program staff to acquaint local high school counselors and students with the program, and is discussed further in a later section.

TABLE 5 - ADMISSIONS DATA

Year	Applied	Rejected		Withdrew		Started	
	Number	No.	Percent	No.	Percent	No.	Percent
1967	46	12	26.0	8	17.5	26	56.5
1968	42	5	12.0	14	33.0	23	55.0
1969	33	6	18.0	9	27.0	18	55.0
1970	51	10	19.5	12	23.5	29	57.0
1971	70	19	27.0	18	26.0	33	47.0
TOTAL	242	52	21.5	61	25.0	129	53.5

On the average, it can be seen that between one-fifth and one-quarter of all applicants were rejected each year due to their poor preparatory achievement; a further 25 percent withdrew or did not appear for registration, so that about 50 to 55 percent of all applicants could be expected to begin classes. With the increase in applicant numbers during 1971, this percentage showed a decrease, but no guide towards whether this may be a continuing trend can be determined from data presently available for the 1973 entry.

Appendix J provides background data available for all students who started classes; as in any freshman class, a wide range in background was apparent with a varying mix each year among students entering straight from high school, men with experience in the military, men with previous college experience, and with previous



fishing experience. It is notable that a number of older men, and men with previous college education to the baccalaureate level, or above, passed through the program in order to obtain the applied knowledge it provided.

#### Grading and Required Achievement Levels

The standard grading system used by the University was applied to all coursework throughout the program. This used the letter system with quality points being awarded for each course, depending on the grade earned and the number of credits involved. The letter grades used were: A = Superior; B = Good; C = Average; D = Below Average but Passing; F = Failure. For each credit in a course, four quality points were awarded for a grade of A, three for a grade of B, two for a grade of C, and one for a grade of D; zero quality points were applied to a grade of F. As an example, if a student was awarded a grade of B in a three-credit course, he earned nine quality points.

In order to graduate, a student was required to complete the work of the curriculum, and earn a total number of quality points equal to twice the total number of credits for which he registered; it was necessary that a student repeat any required course for which a failing grade was obtained.

Students were required to maintain a cumulative average of 2.0 or better; where the average was less than eight points below the 2.0 level, the student was placed on academic probation for the following semester and given the opportunity to raise his achievement level; if his average remained below 2.0 at the end of the following semester's work then he was liable for dismissal.

Men liable for dismissal were able to appeal this decision to the Academic Standing Committee of the College of Resource Development, who in consultation with the project director and program faculty then could waive or confirm the dismissal action.

In the case of students with a very strong fisheries background and having poor academic achievement, but who showed good practical ability and progress in skill achievement, dismissal was often waived, or they were permitted to continue as special students registered for particular courses so as to complete as much of the program as possible within the two-year period. It was common that students with this background would express themselves as not interested in graduating but wishing to obtain as much practical knowledge as possible, often

showing good achievement levels in these courses.

Students graduating with a quality point average of 3.7 earned "highest distinction," those with an average of 3.5 earned "high distinction" and those with an average of 3.3 earned "distinction." In each semester, students with a quality point average of 3.0 or better earned "Dean's List" status.

Data on graduation levels for those entrants who graduated are included in Appendix J.

Procedures used to assess achievement and grades varied with each course, and information on the methods of grading will be found in the complete course descriptions forming Appendix G.

#### Performance

Numerical data on the actual performance of students is presented in Table 6. Approximately 50 percent of the students who started classes have graduated or will complete requirements within six months (students who plan to continue in college beyond the two-year level often delay completing requirements for the Associate Degree as an administrative device of no interest here, and are included in the total number of graduates for the 1970 entry). A further 7-1/2 percent completed the two years without meeting requirements for graduation for one reason or another; they all had previous experience in the fishing industry, and returned to fishing following completion of two years in the program.

TABLE 6 - STUDENT PERFORMANCE DATA

<u>Year of Entry</u>	<u># Start-ing</u>	<u># Gradu-ating</u>	<u># Completing 2 Years But Not Graduating</u>	<u># Withdrawn</u>	<u># Dismissed</u>
1967	26	11	2	6	7
1968	23	14	1	8	0
1969	18	12	3	3	0
1970	29	10	1	15	3
TOTAL	96	47	7	32	10

One-third of the total of those entering have withdrawn, either because the program did not suit their needs or to save being dismissed, and 10 percent have been dismissed.

Of the 47 graduates, 8.5 percent graduated with the "highest distinction," 10.5 percent with "high distinction" and 10.5 percent with "distinction." The complete data for performance of graduates is contained in Table 7.

TABLE 7 - PERFORMANCE OF GRADUATES

Year of Entry	Level of Graduation				Total Graduates
	Pass	Dist.	High Dist.	Highest Dist.	
1967	7	1	1	2	11
1968	9	1	3	1	14
1969	10	-	1	1	12
1970	7	3	-	-	10
TOTAL	33	5	5	4	47

A large proportion of all students entering exhibited poor high school preparation in mathematics, physics, and a general ability to write clear, concise descriptive material using sketches as an aid to presentation.

The most important lack was in computational ability and the use of simple formulae and trigonometric ratios. Although material in the program was placed in as simple a form as the various subject areas allowed, a large number of the students entering each year proved unable to handle even the simplest calculations and were seriously held back in achievement because of this. The mathematics course was re-arranged to help provide this ability and was found of use by a number of students who later successfully graduated.

In physics, the lack was in the understanding and use of basic principles, and in most cases students unable to handle the program's work in this area were also severely handicapped by an associated lack of math skills. Instructors in most of the courses emphasized the basic

skills in physical principles and computation in order to assist students in raising their achievement in these areas.

The use of clear concise writing, using sketches to illustrate descriptive material, was apparently not in keeping with students' previous preparation in many cases; emphasis was therefore placed in this area in the composition course and also in the introductory fisheries courses, where it was applied to actual descriptions of fishing operations with some success.

Discussions with students exhibiting poor achievement in these areas indicated that most of them, before learning about the program, had not expected to enter college and had not expected to need such ability in work connected with the fishing industry; they had therefore failed to place effort in the relevant subjects during their school years. As a result of these findings, every effort was made when visiting schools, or when interviewing prospective students on campus, to emphasize that mathematics and the other problem areas were as much tools for fishermen in their future work as the hammer, the knife, the wrench, or the twine needle.

#### Effect of Performance on Student Numbers and Section Size

The performance of students is important from the viewpoint of class size and number of sections needed for laboratory courses, which was determined from the number of students beginning classes each semester. The relevant figures are provided in Table 8.

TABLE 8 - STUDENTS COMMENCING EACH SEMESTER'S WORK OF THE PROGRAM

<u>Year of Entry</u>	<u>Number of Students Commencing Each Semester's Work Semester 1</u>	<u>Semester 2</u>	<u>Semester 3</u>	<u>Semester 4</u>
1967	26	21	16	13
1968	23	19	15	15
1969	18	17	15	15
1970	29	24	16	11
1971	33	29	19	NA

NA = Not Available.

In assessing the data of Table 8, it should be noted that there was an unusually small entering class in 1969, the proportion remaining each semester being high. The class entering in 1970, although larger in numbers, was noted by the faculty as showing a relatively low number of students expected to graduate and this is reflected in the low percentage of graduates and generally low performance levels shown. The 1971 entering class is expected to show a similar performance to those of 1967 and 1968. Using these three classes as typical, it could be expected that between 80 and 85 percent of the students entering would remain for the second semester, a further group falling out during that semester to leave between 60 and 65 percent to begin the third semester (second year); further attrition during the second year may or may not occur.

It is particularly noticeable that most of the students dropping out have done so during the first year, so that the number beginning the second year has been relatively independent of the entering class size.

On considering these results within the framework of the discussion on desirable laboratory section size in Chapter III, it may be stated, as a first approximation, that the following number of sections are required for skill development laboratory sessions, assuming a student entry of between 36 and 40.

First semester:	4 sections of 9 - 10 students
Second semester:	3 sections of 10 - 11 students
Third semester:	2 sections of 10 - 12 students
Fourth semester:	2 sections of 8 - 10 students

These figures are considered to represent a reasonable guide for use in formulating requirements for this type of program.

#### Criteria for Graduation

Students entering the program showed a wide range in background and preparatory scholastic achievement; data collected by the Office of Admissions and summarized in Appendix J included details of aptitude test scores, high school class rank, military and previous college experience. Information on previous connection with the commercial fisheries, either through work experience or family connection, was available through the questionnaire or knowledge of individual students.

In order to determine whether any of these factors or interactions between them were relevant to student

success in graduation, an analysis of variance was run using the available data, which was sufficient to provide a satisfactory sampling.

The following criteria were used: a) scholastic aptitude test scores average above or below 500, b) veteran or non-veteran, c) some previous college experience, or no previous college experience, d) previous fishing experience, or no previous fishing experience.

Using a conventional F test, it was found that the following factors and combinations were significant or highly significant as criteria leading to graduation:

Highly Significant: Average test scores above 500  
Significant: Previous college experience, and military service combined with college experience.

The results of this analysis were unexpected in that previous fishing experience was not a significant factor, on its own, leading to success, whereas the standard scholastic aptitude tests appear to provide an indicator for use in assessing the likelihood of graduation.

A further examination of the scholastic aptitude test scores of students who graduated from the program showed that:

- No student with less than 275 average test score has graduated.
- The minimum average test score of students who were able to graduate within two years is 325.
- Seventy-five percent of graduates have shown average test scores on entry of above 425.

Faculty knowledge of individual students indicates that, without exception, students who graduated with average test scores below 350 at entry have shown particularly strong motivation and determination to succeed; in three out of four cases, they required an additional year to complete requirements for the Associate Degree.

The highly significant role played by achievement scores indicates that this may be as much a criteria for success in this type of applied program as for other areas. The extent to which this finding forms a basis for admission decisions is felt to depend on the aims of a particular program.

In this program, the general aim was to provide better educated and trained fishermen; students with previous experience or family connections have generally entered the industry whether or not they graduated, and in nearly all cases have derived some benefit from their stay in the program, which will assist their career. This consideration must be weighed carefully before any decision is made to exclude such students purely on the basis of test results or preparatory achievement.

An important factor to be considered in any such actions is possible loss of support from the local fishing community if their sons are denied a chance to undertake at least some training in their field. The importance of support from the fishing community cannot be over-emphasized.

#### Employment and Achievement of Graduates

Success of graduates in achieving and holding positions in industry has been mentioned previously. Of the 47 who have graduated, 80 percent obtained suitable employment in some sector of the commercial fisheries or an associated marine industry. The remaining 20 percent elected to continue their college education, which in several cases was financed by a part-time fishing operation.

Two graduates (4% of the total) found themselves unsuited to a career in the fishing industry and entered other fields within the first year of work experience. All other graduates from the first three entries have continued working in the industry up to this date, or have been forced to leave due to military commitments.

A summary of the graduates entering industry or continuing their education, together with the numbers successfully completing one year's experience, is given in Table 9. Of the graduates entering industry, 70 percent were employed in the sea-going commercial fisheries, 13-1/2 percent in shore-based activities connected with the fishing industry, and 16-1/2 percent in either sea-going or shore based work with associated marine industries. A summary of the numbers entering each sector is shown in Table 10.

A number of graduates, most of whom had extensive fishing experience before entering the program, are owner/skipper of their own vessels, others have progressed to skipper or officer positions after entering at the deck-hand level in the sea-going sector. Typical positions

TABLE 9 - DISTRIBUTION OF GRADUATES TO INDUSTRY AND FURTHER EDUCATION

Year of Entry	Total Graduates	Graduates Entering Industry		Graduates Continuing Education	
		Number	Number Employed After 1 Year	Number	Number Remaining After 1 Year
1967	11	10	9	1	1
1968	14	12	12	2	2
1969	12	8	7	4	4
1970	10	7	NA	3	NA
TOTAL	47	37	NA	10	NA

NA = Not Available



taken by students ashore are as trainee plant managers, work with government agencies as technicians, or in one case as a Fisheries Development Officer. Positions in associated industries included fisheries technician aboard an Antarctic survey vessel, owner/skipper of a charter sports fishing vessel, and mate of a party fishing vessel (head boat).

TABLE 10 - DISTRIBUTION OF GRADUATES TO FISHING  
INDUSTRY AND ASSOCIATED INDUSTRIES

Year of Entry	Commercial Fishing At Sea	Fishing Industry Ashore	Associated Industry
1967	6	3	1
1968	9	1	2
1969	6	-	2
1971	5	1	1
TOTAL	26	5	6

A listing of the employment history and achievement of graduates was maintained following the entry of the first graduating class to industry, and this is summarized in Appendix D.

The commercial fishing industry, in general, is noted for lack of response to distributed questionnaires, so that on the advice of those faculty having close connection with the industry, this means of following up graduates' activities was not pursued. In its place, the information was gained by a process of individual interviews between program faculty, graduates, and employers. The close connection maintained with the industry through various faculty members assisted greatly in this. It was found that faculty having immediate connection with day-to-day industry activities were able to obtain an in depth assessment of graduates' strengths and weaknesses through informal discussions with their colleagues aboard other vessels. Interview activities were undertaken primarily by these people, therefore, and found particularly useful in the case of graduates employed at Point Judith and New Bedford.

Many graduates took employment in other areas of the United States; in most cases, contact with these individuals and their progress was maintained through correspondence, visits from ex-students, and through the wide contact maintained by all faculty with their associates in various phases of the industry throughout the country. Visits to other areas for meetings, and especially for FISH EXPO, which drew visitors from all over the country, were found particularly useful in this activity.

The close connection between faculty and students developed during the program has been found to continue after graduation, and it is usual for graduates, when in the Rhode Island area, to visit the program facilities at Wickford. Many former students have kept in contact with friends working in other areas of the country and visit with them; they have been found an extremely effective source of information on employment and achievement.

The wide diversity of graduates' activities made it extremely difficult to undertake a measurement of their achievement. In the case of those employed as crew members aboard fishing vessels, it was thought to be relatively simple to measure progress by means of such factors as promotion from deckhand to engineer, mate or skipper; however, the difference in quality of crews aboard different vessels tended to negate this approach. For instance, one graduate from the first class in 1969 began as a deckhand aboard an offshore lobster vessel out of a Massachusetts port; within a year he had been promoted to skipper, but left the company in order to take a position as deckhand with Point Judith's "high line" fisherman. In terms of earnings, this may be a more favorable situation but not in terms of position.

Other graduates form four-fifths of the crews of two vessels of the same owner, and all work at their specialized activities as a team to maximize earnings. Another graduate took a position as technician aboard an Antarctic research vessel for a year, and then returned to work his own small vessel from a port in his home state of Alaska.

The use of earnings as a criterion for achievement was not found to be justified due to the difference in levels common to different areas of the country, together with the difference in life styles desired by individuals, many of whom preferred to work with their own small operation in their home area rather than undertake the regular longer voyages aboard vessels from major ports.

It was concluded, therefore, that the achievement of graduates should be a qualitative rather than a quantitative judgment, each case being considered individually. The complete listing of graduates was therefore prepared for Appendix D to enable the wide range of occupations to be visualized. It can be expected that over a longer period, as more graduates advance in employment within the industry, a more discernible trend will develop, but insufficient time has elapsed at this stage to allow this.

Faculty members with close industry connection also became involved in the comparison between achievement of graduates and other young men who entered the industry without passing through the program. Again, it was not found possible to produce a meaningful quantitative assessment, but through informal discussions with industry people, it did appear that graduates entering the industry had the advantage of specific skill requirements allowing them to begin as full share deckhands, together with the background permitting advancement to more responsible duties as openings became available. The rate of promotion was slower aboard the better vessels, and more rapid aboard vessels having a greater turnover in crews. It became usual for the best skippers to hire graduates whereas they did not normally take on inexperienced men.

Fishermen felt that graduates were able to take their place in the industry following a short period of familiarization with a particular vessel or equipment, and were between five and ten years ahead of entrants without the training; also, it was felt that graduates possessed the knowledge to advance rapidly if they wished, depending on development of their individual attitude and competence.

#### Employment of Non-Graduates

Thirteen students who entered the program, but who did not graduate, have entered the fishing industry, all but two as a result of previous experience or family association. All these men have remained at this work until the present time, and appear to be well settled in their life.

#### Placement of Graduates

When attempting to place graduates, it was found necessary to take into account the widely varied operational arrangements found in the commercial fishing industry. Fishing vessels are normally operated under ownership of a vertically integrated company, or under

private ownership by either an absentee owner or skipper/owner. In the case of a company owned vessel, individual skippers are often solely responsible for the hiring and firing of crew, although in a growing number of companies this is being undertaken with the aid of the owner's personnel department. With privately owned vessels, the skipper (often in consultation with the owner) will personally deal with all crew matters.

Normally, placement was made through personal contact between individual graduates and the skipper or owner of a vessel aboard which a man wished to work. In this sector of the industry, therefore, the usual procedures of job-finding, using a placement office or through letters, proved completely ineffective, and it was necessary for graduates to make a personal approach, following up leads which pass around the waterfront. The wide range of contacts available in the industry through various faculty members was found particularly useful in placing graduates in the private sector, but in all cases this could only be used to provide a guide and recommend a student, it being necessary for the individual to take the initiative in seeking out the industry people concerned.

A number of the larger or newer companies operating vessels either contacted the program director or were contacted by letter; they apparently preferred to work in this direct manner rather than through the University Placement Office, again because of the individual nature of recruitment in the industry, and because they were generally looking for "skipper potential." This approach proved disappointing, however, and only one student obtained employment (as a skipper) in the commercial fishing industry following formal contact between a company and the program director. As in the private sector, a much more effective means was for a graduate to present himself personally to the company

The majority of fishing vessels do not operate under a union/owner agreement, but in some New England ports this is required, in which case it proved necessary for graduates to fulfill union membership rules, which could usually be achieved following a short period as a "trainee" aboard a vessel.

It was usual for graduates who did not have existing industry connections to make a number of contacts for possible employment during the final semester, and individuals showing good potential often found they had a choice between several "sites." Often employers or skippers with whom a student had worked during the summer

training period would find a place for him after graduation.

Students who wished to establish their own operations usually began making arrangements during the final year, in order to begin fishing as soon as possible after graduation.

Personal contact and faculty connections were also the principal means of arranging employment for graduates wishing to work in the industry ashore, or in associated industries.

### Recruitment

During the early years of the project, applications for admission resulted from natural publicity in the local press and the national fisheries press.

In late 1966 and early 1967, news releases were used to inform the fishing industry through fisheries papers and journals, and the general public through newspapers, about establishment of the program. This publicity had two aims: to assist in the search for a full-time project director and staff, and to alert schools and interested young people to the unique and new educational opportunity presented by the program.

As a further aid to recruiting, a fold-out pamphlet was produced entitled, "CHALLENGE - A new program in commercial fisheries at the University of Rhode Island"; it featured photographs illustrating various aspects of commercial fisheries and an explanation of the program's aims and proposed course content. This pamphlet was distributed to schools, youth organizations, government establishments, and other institutions that might have contact with potential students.

The effectiveness of this approach in spreading information was confirmed by the applications coming from such widely separated areas of the country as Alaska, California, Florida, and Puerto Rico, in addition to many from the New England States. It resulted in a most convenient size for the first entering class, as shown in Table 11, which presented a reasonable distribution of students from various areas.

During late 1967 when classes had started, a revised version of the pamphlet "CHALLENGE" was prepared and distributed to schools and institutions as well as to the press and commercial fisheries organizations. The counselor undertook a series of visits to schools in

fishing areas throughout New England as an additional means of informing prospective students of the educational opportunity available through the regional program. At this time, the press was following developments and several news releases assisted in making the program known.

TABLE 11 - STUDENTS ENTERING PROGRAM  
BY GEOGRAPHICAL AREA

<u>Year of Entry</u>	<u>Rhode Island</u>	<u>Other New England States</u>	<u>Other Areas of U.S.</u>	<u>Foreign Countries</u>
1967	11	11	4	0
1968	10	9	3	1
1969	3	13	1	1
1970	15	7	7	0
1971	20	10	3	0
TOTAL	59	50	18	2

The second year class showed very much the same distribution as the previous entry, with the addition of the first foreign student. Once the program had passed the initial development stage, press action slowed; during late 1968 and early 1969, the counselor also restricted his program of school visits.

At this time, information on the program was beginning to be published in various national directories on ocean-related education programs. These directories have proved an effective means of recruiting, apparently being used as references by many young men seeking education and training in ocean-oriented activities, and resulting in a considerable number of letters of inquiry each year, especially from areas outside New England and from servicemen.

The rather disappointing total of applications and the small entering class in September 1969 indicated that greater efforts would be needed to acquaint prospective students with the program. As shown in Table 11, a representative selection of students from other

states appeared, but those from Rhode Island showed a sharp decrease, appearing to indicate where recruitment should be concentrated. A particular effort was made during late 1969 and early 1970 to take information on the program to the high school students of Rhode Island.

Two important pieces of informational material were prepared to assist in making high school students aware of what is involved in the fisheries program: a new descriptive booklet, and a visual presentation using slides and a 16mm film showing the facilities available at the University, with action shots of students working in the laboratories, aboard the training vessel, and aboard a commercial vessel.

The 18-page booklet was entitled "The Commercial Fisheries Program - University of Rhode Island," and featured descriptive material on program activities, Coast Guard Licenses, instruction and facilities, the curriculum and course outlines, and details of student fees and expenses, together with ten photographs illustrating the various facilities, student activities and faculty. A section entitled "A Day on the GAIL ANN" (the training vessel), written by a student was also included; this will be found in Appendix M.

As with previous informational material, the booklet was distributed to schools, fisheries organizations, colleges and other institutions, and in response to letter requests. The larger format was found particularly useful by school counselors, as it did not get pushed aside or mislaid as easily as the previous pamphlets.

All members of the staff participated in the school visit program; presentations were made to student groups, including both senior and junior classes, at about a dozen high schools in late 1969 and early 1970. It was noticeable that this time period coincided with the upsurge of interest among students in marine matters, conservation, and the environment. In all cases, program representatives were well received, the visual materials being especially appreciated by both counselors and students. The most effective staff members involved in the activities were an experienced fishing vessel owner/skipper, who many students apparently considered to represent the competence and success they were seeking, and a young man who was able to relate directly with activities in which students would be involved in their immediate future. Most of the high school visitation programs were therefore undertaken by these staff members.

Following this experience, the visual materials were developed further. The 16mm film material had been found especially effective so that a commentary was prepared and placed on a tape cassette to be played in synchronization with the silent film. This was used during the last part of the school visit program, the slide materials being omitted. The combination of film and taped commentary proved extremely effective, and was developed further for the following year's visit activities by placing a sound track on the film.

These efforts proved successful in making prospective students aware of the opportunities, as shown by a sharp rise in the number of applications and students entering from Rhode Island in September 1970.

The success of the high school visit program, both in terms of recruitment and in assisting the school counselors, resulted in invitations to repeat the visits the following year, when activities were expanded to include several additional schools. The 16mm sound film material was found to represent an even more effective aid to presentation than the mainly visual material used the previous year. A further increase in admissions from Rhode Island schools resulted from that year's activities, as shown by the figures in Table 11 for 1971. On questioning students from Rhode Island who commenced classes, it was found that about two-thirds had entered as a direct result of the school visit program.

Other informational activities undertaken by program staff, both of a general nature and as an aid to recruitment, included press articles, radio talks, and two television appearances in shows beamed to local fishing communities in Connecticut and Massachusetts as well as Rhode Island. Talks to fishermen and fishermen's wives organizations were found particularly fruitful.

Each year the program was represented at FISH EXPO, the U.S. International Fisheries Exposition that started in 1968. In addition to a booth display manned by staff, various faculty members played a full part in the associated seminar programs in order to acquaint the fishing industry with the program. As FISH EXPO was held in different areas of the country, this proved an effective means of information dissemination, which was assisted by the use of an 8mm film cartridge display on a self-contained projector unit. This cartridge was prepared from the 16mm material and attracted considerable attention at the booth display in 1970 and 1971.



## Faculty/Student Relationship

When at sea, the commercial fisherman works in close company with other crew members for perhaps weeks at a time; all are mutually dependent for their earnings, safety, well-being, and maintenance of a harmonious relationship. If accidents are to be avoided when working with the heavy and dangerous machinery aboard, and in close proximity to moving wires, each crew member must be entirely competent and mutual trust is essential. Fishermen tend, therefore, to be self-reliant, often individualists, but blend to form a crew which must work together as a team.

In addition to the academics and skill achievement, it was considered important that the work of the program assist graduates to attain the required working relationship along with the accelerated maturity it required.

Efforts in this area involved a much closer and more continuous relationship between faculty and students than is common in many educational programs. The concentration of fisheries courses, where students spent their full time, during the day, at the waterfront facilities away from the main campus, assisted considerably in this, and it was during this period that students learned to work as individuals gaining self-responsibility, while blending together as a "crew" when appropriate.

Faculty-student contact was virtually continuous during the second year, either formally during class sessions or informally outside regular contact hours. It was usual to see groups of students either working together with a staff member outside their class hours, or in informal discussion groups.

Although students were encouraged to think about and discuss all aspects of their work, considerable emphasis was placed on when such questioning and discussion was appropriate and when not appropriate for working in the industry. This required faculty to establish an appropriate working relationship with students; while friendly, open and frank, it was important that the attitude of individual faculty leave no doubt in students' minds as to their individual competence, interest in students' progress and activities, and above all in their authority and determination that all-round standards would be maintained.

It has been the consensus among faculty that these activities form an essential phase of preparation for the close, continuous relationship and contact with skipper

or owner/skipper found aboard most fishing vessels. The importance placed on experience in some sector of the industry on the part of all faculty involved, must be emphasized; due to the difference between life at sea and in industry ashore, the usual type of counseling and formal coursework in personnel and industrial relations was found ineffective.

The process as developed involved a continuous procedure from the first meeting with students; during the first year emphasis was placed on carrying out simple tasks in a professional and workmanlike manner with a minimum of "fuss and bother," and this was found to provide a sound basis for the accelerated process of gaining the maturity necessary for work at sea.

#### The Student Association and Activities

The bond between students in the program has been assisted by the formation of the Student Marine Fisheries Association as a club within the Student Union at the University. This Association has been run entirely by a student committee with the aid of a faculty advisor chosen by the students. The choice of advisor, a successful and experienced fishing vessel owner/skipper, again points up the importance placed by students on competence and success in the industry.

The Association has provided a full range of fisheries and maritime related journals and publications, placed in a room provided in the waterfront facility. It has also operated a successful program of visiting speakers, and a social program, including seafood bakes in the fall and spring. The constitution was arranged to permit freshmen students to play a part in governance to prepare for the more complete operation of the association during their second year.

The visiting speakers program was the most important activity of the Association, between six and twelve such sessions being arranged each year. Topics have included Maritime Law and fisheries limits, vessel design and equipment requirements, fishing gear technology, and fisheries business operations. Speakers have come from all areas of the fisheries and associated industries, including a fishing vessel designer, representatives of engine and equipment manufacturers, fish plant managers, fisheries biologists and commercial fishermen. The many international visitors to the Department of Fisheries and Marine Technology each year from FAO, AID, fisheries journals, fisheries development units, universities, and research institutions have played a full part in these

activities, which are considered to form an important broadening function in connection with the program's formal classwork.

Registrants in the two year fisheries program have played a full part in the more general student activities at the University, including fraternities, intercollegiate athletics, and many student societies.

The majority of first year students, especially those entering directly from school, have resided in one of the dormitory complexes on the main University Campus, many of their classes being held there. This has permitted them to become involved in the many facets of university life, and it has been found that these associations have continued during their second year, when all class time has been spent at the waterfront facility.

This arrangement has been found most valuable in providing students with the usual advantages of a university education while concurrently permitting the particular training and preparation required for the commercial fishing industry, as noted in the previous section.

#### Experimental Summer Program for High School Students

During August 1969, a two-week summer school program was operated with the general aim of introducing interested high school students to the varied work of the commercial fisheries. If successful, it was intended to continue with similar programs annually as a means of allowing young people to determine whether this was a field in which they wished to continue. It was also felt that the program would assist in recruiting.

Pamphlets explaining the program were distributed to all high schools in Rhode Island and coastal areas of New England; press releases were used by Rhode Island newspapers and by national fisheries magazines; in addition, public service radio spots were used to disseminate information concerning the program. A number of articles and photographs of actual activities were later used by newspapers.

A flexible and informal schedule was put together, which included short talks each day on various aspects of the commercial fisheries, followed by practical work with engines, fishing gear, electronic aids, navigation, seamanship and afternoon trips aboard the training vessel. Considerable use was made of visual material and "hands on" instruction, together with visits to local fishing ports, fish plants and shipyards.

The number of participants was restricted to sixteen in order to permit adequate contact between faculty and students. The program was aimed at high school seniors and juniors, a total of over thirty applications being received, from which sixteen were selected on a basis of interest and recommendation from school principals.

All students were housed in one wing of a university dormitory on campus, with a resident counselor, and in addition to the day-time activities, evening film shows were provided and several outside barbecues arranged, including a seafood bake on the final evening.

As a result of activities during the first few days, it was found that many of the students were relatively uninterested in the fisheries related work, so that a more extensive program of general activities was put together for the second week, including swimming, seashore and beach excursions. On investigation, it was found that the program was being used, in many cases, as a means of occupying the boys during two weeks of their summer vacation rather than from any viewpoint of interest in the activities. In addition a considerable problem was experienced with the young people being housed together with the more mature residents common to university summer school programs.

A third of the students proved genuinely interested in participating, and they gained a number of skills, particularly in seamanship, twinework and simple navigation, in addition to a basic understanding of the commercial fisheries. One participant later enrolled in the Two Year Associate Degree Program.

On evaluating the program following its completion, it was concluded that it should not be repeated in a similar form. The two-week period was felt to be too long, resulting in students becoming bored. A more suitable arrangement might occupy two or three days with activities being much more carefully planned and intensive in nature, with free time kept to an absolute minimum. In addition to making full use of the shorter time period, this would tend to ensure that only interested students participated so that program staff did not become purely "baby sitters."

During the following two summers, program faculty were fully occupied in construction activities connected with the establishment of facilities, so that it was not possible to test the use of a revised program.

## CHAPTER VI

### FACILITIES

The location and outfitting of suitable facilities proved to represent the most difficult problem to be solved during establishment of the program.

The position of the University's main campus some six miles from the ocean, coupled with the need to operate and berth a training vessel, led to two courses of action being available. It was necessary either to establish all teaching facilities at the main campus, with the vessel berthed at the nearest suitable port, or to set up major facilities and vessel berthing at one location, with a minimum of classes being held at the main campus.

Initially, the most important consideration was the provision of sufficient laboratory space to permit a start of classes in September 1967; as no suitable building was available on campus, a search was made for a location within a reasonable range of this main base. The only building available at the time was some two miles from the main campus and adjacent to a federal government water pollution laboratory. This building was rented, therefore, as a temporary measure in order to get the program underway, with facilities for teaching practical seamanship and fishing gear.

Experience in using the facility provided guidance concerning a more permanent location; it was found that the motivation and achievement of both faculty and students suffered from being forced to undertake work associated with the ocean at a location set in a farming situation. The obtaining of waterfront facilities was determined as a high priority requirement.

#### Location of Waterfront Facilities

Three possible sites were identified: at Galilee, home port of the local fishing fleet, at the University's Bay Campus on Narragansett Bay, and in the port of Wickford, also situated on Narragansett Bay.

The advantages of a facility closely associated with the commercial industry were clear, so that first consideration was given to Galilee as a permanent waterfront location; however, no building of sufficient size was available, and although several sites were suggested for new construction, none was available within a reasonable

time scale. From the viewpoint of vessel operation, on leaving the dock at Galilee it would have taken a considerable portion of available class time to reach a reasonable fishing area for training, and an analysis of weather conditions indicated that the vessel would be able to sail on only some two-thirds of the class days during the academic year. The idea of locating at Galilee was therefore dropped.

The University's Bay Campus provided an opportunity to establish permanently within state property, and was close to reasonable fishing grounds for training purposes. It would have been necessary, however, to construct completely new facilities, which was not possible within the required time scale, or within funding arrangements. In addition, berthing facilities available were considered too exposed for regular use by a small vessel handled by students under training, without considerable damage resulting. This location was therefore discarded.

The port of Wickford has proved an excellent base of operations for the training vessel, regular trips being possible and virtually independent of the weather (Chap. VII). In addition to the presence of several large marinas and a shipyard, commercial fishing vessels made use of the port's proximity to good fishing grounds within Narragansett Bay, so that a suitable commercial atmosphere was available. The shipyard at which the training vessel was berthed indicated their willingness to make an existing building available and construct additional space to meet the program's requirements, both of which could be used on a rental basis. The permanent waterfront facility was therefore established at this location, which proved excellent for the purpose.

#### Construction of Facilities

Construction of the waterfront facility was undertaken in two stages. The existing building was occupied in June 1968; necessary construction work, including interior walls and complete painting, was undertaken by program staff during the summer, and equipment installed to provide laboratory facilities for seamanship, navigation and electronic aids, together with a classroom for use when classes commenced in the fall. One faculty member and the technician established offices in the building, where space was also arranged, temporarily, for nets and gear storage associated with the training vessel operations.

Outline specifications were prepared for the second building during early 1969, and following successful

completion of negotiations with the owners for a long lease arrangement, construction commenced later that year, with occupancy in February 1970. In the meantime, teaching work in engineering and fishing gear was centered at the temporary building in West Kingston near the University's main campus, scheduling being arranged to permit students to spend full days at one location wherever possible.

The new building was constructed and leased as a shell structure including a heating system. Much of the internal construction, outfitting, and installation of equipment was undertaken by program faculty and staff during the summer of 1970, and work completed the following summer to provide practical facilities for fishing gear and marine engineering technology. In addition, a tool room and small welding shop were included at ground level, and a second level loft built to provide office accommodations, a carpenter shop and storage facilities for twine and fishing gear supplies.

With completion of the new building outfit, the older structure was arranged during the summer of 1971 to provide increased office accommodations, a student lounge and reading room, a staff room, an electrical laboratory, and a central reception area with library and visual aids facilities.

Through the faculty and staff undertaking all construction, it was found feasible to develop a facility meeting the exact specifications required by individual instructors, and obtain a much more extensive level of outfitting than would have been possible if contractors had been employed. This was primarily due to cost savings inherent in the "do it yourself" approach, which allowed funds to be allocated for additional equipment.

#### The Completed Facilities

A general layout of the completed complex is shown in Figure 1, with layouts of individual buildings in Figure 2. The general view of the completed facility provided in Figure 3 enables the overall arrangement to be visualized.

The two main buildings are arranged side by side with a paved area between, which is used for net storage in specially constructed rat-proof boxes (Fig. 4).

The existing two level building (Number 1) to the south (right-hand side of Fig. 3) is arranged to contain laboratories, offices and other areas requiring only

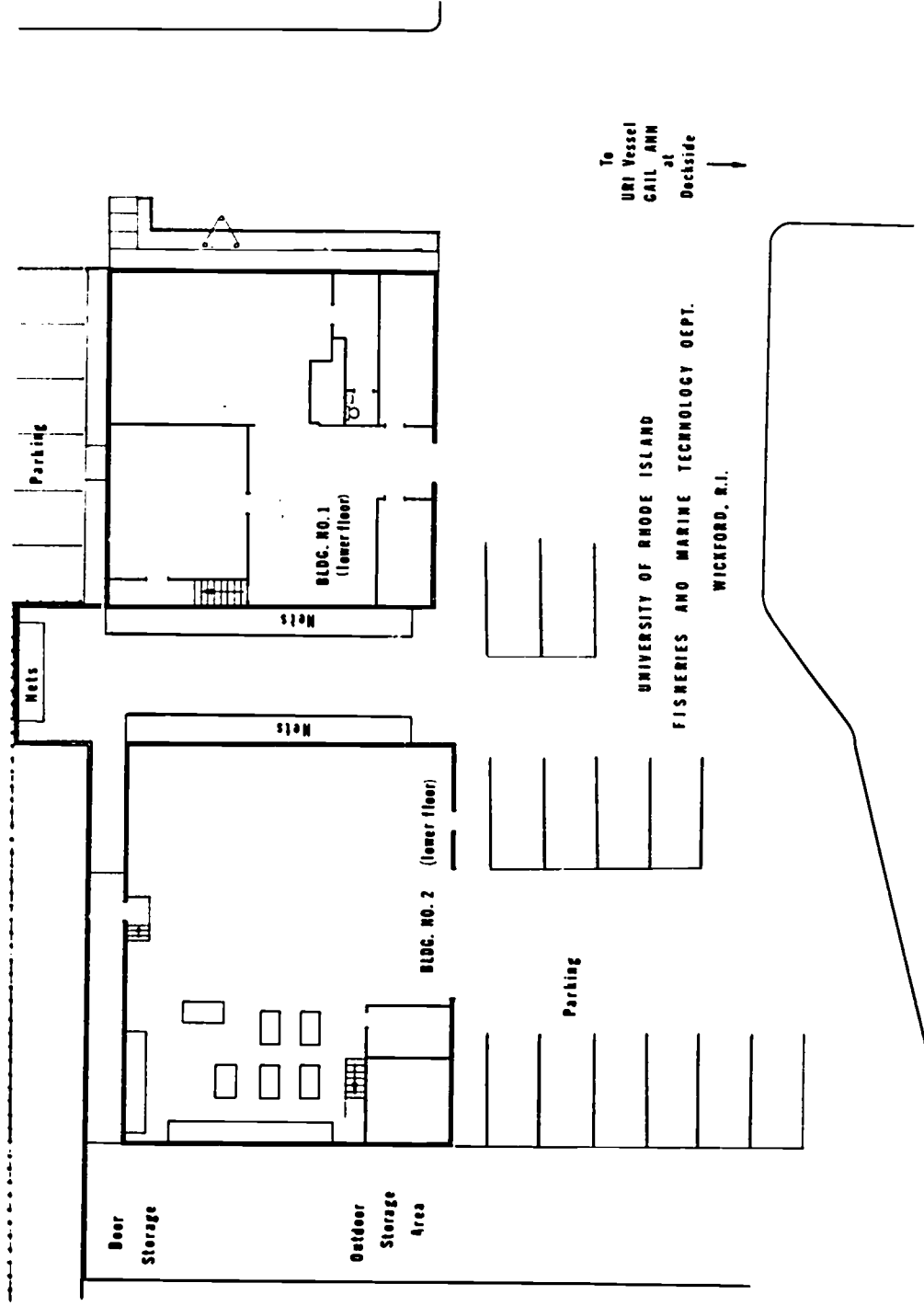

Figure 1. Area Plan of Wickford Facility.



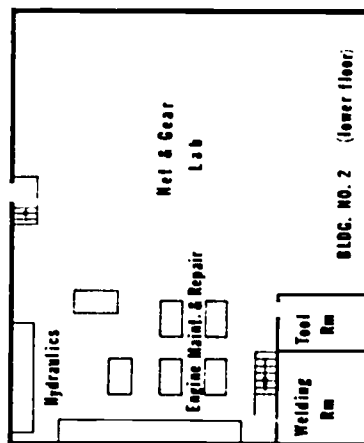
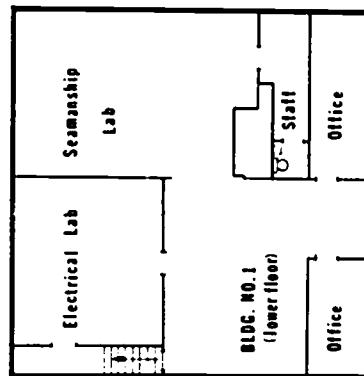
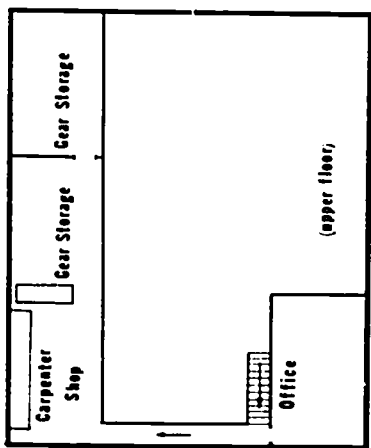
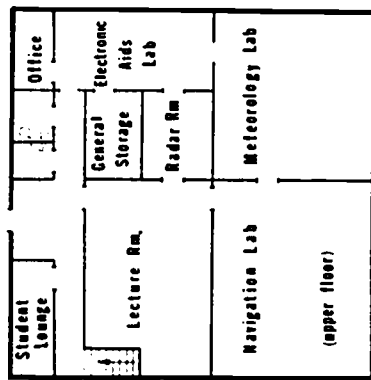

Figure 2. Arrangement Plan of Buildings.

normal headroom. The new building (Number 2) to the north is constructed with 20 foot high eaves permitting adequate height both for nets and gear work, and to allow a traveling beam overhead hoist for the engineering technology laboratory. The 18-foot high lifting door allows adequate clearance for the entry of trucks and movement of equipment and small craft in and out of the building.

A tower constructed of three standard telephone poles with a walled platform is arranged on the south side of the area and provides a mount for a live radar antenna, meteorological equipment, and antennas for electronic position-fixing equipment and a private VHF radio network for contact with the training vessels. Along the northern side of the area, space is arranged for storage of the fishing equipment, such as net drum, several sets of trawl doors, dredges, beam trawl, the seine skiff, and other heavy items used aboard the training vessel for the various fishing operations undertaken. Two dories mounted on a trailer are also stored in this area, when not in use.

The following areas are arranged in each building:

BUILDING NUMBER 1 (FIG. 2) - TOTAL FLOOR AREA 5,000 SQ. FT.

		<u>Square Feet</u>
Lower Floor	Reception Area	524
	Director's Office	175
	General Office	96
	Staff Room/Galley/Toilet	154
	Electrical Laboratory	410
	Seamanship Laboratory	675
Upper Floor	Student Reading Room	100
	Lecture Room	420
	Wash Rooms	75
	Electronic Aids Laboratory	290
	Radar Room	120
	Meteorology Lab/Office	364
	Navigation Laboratory	456
	Faculty Office	75
Storage Rooms	200	

BUILDING NUMBER 2 (FIG. 2) - TOTAL FLOOR AREA 3,960 SQ. FT.

Lower Floor	Nets & Gear Laboratory	1,500
	Engineering Tech. Lab	1,250
	Tool Room	96
	Welding Shop	144

79/80

Upper Floor	Faculty Office	240
(loft)	Carpenter Shop	240
	Fishing Gear Storage	480

When arranging and outfitting the spaces, it was necessary to provide for support facilities to undertake maintenance and repair work within the buildings, aboard the vessels, and with the small craft used in the operations. This was necessary as none of the regular campus services were available; as finally completed, the facility is entirely self-supporting except for major construction and hauling arrangements for the principal vessels, which is undertaken at an adjacent marine railway in the shipyard.

### Detailed Description of Facilities

#### BUILDING NUMBER 1

This two level structure is outfitted as the administrative center for the facility, in addition to providing work areas of the non-workshop category.

The Reception Area is arranged as the main entrance; it is outfitted with a small library containing a wide range of books connected with the commercial fisheries and more general marine areas, together with a small student work area. One wall is fitted with display boards, which feature material important to various subject areas on a rotating basis, together with a general notice board. Cupboards are arranged for storage of visual aids equipment, films, and other teaching aids. A display case is shown in Figure 5. It contains models of seven types of fishing vessels, including an eastern rig New England side trawler, a stern drum trawler, a Gulf-type shrimp trawler, a seine netter, a purse seiner, a wet fish stern ramp trawler, and a stern freezer factory ship. These models are used as teaching aids in various courses during the program. Direct entry is gained to the general office, program director's office, seamanship laboratory, electrical laboratory, and stairs to the upper floor.

The Electrical Laboratory is used for the marine electronics course. It contains equipment for practical work in electrical circuitry, both AC and DC, motors, generators, and a complete electrical load simulation system, including ignition arrangements for a typical small fishing vessel (Fig. 6). The area also serves as a service facility for electrical and electronics equipment used in laboratory teaching, fishing gear experimental work and aboard the training vessel. Positions

are arranged for a maximum section of ten students.

The Seamanship Laboratory. The general layout is shown in Figure 7. Benches are arranged around three walls to provide work positions for a maximum of fifteen students, although a maximum section size of ten is used during normal teaching. Along the center, two levels of horizontal wires are situated to enable wires and ropes to be taken to each work position (Fig. 8). The lower wire also supports lengths of rope used in the formation of knots, bends and hitches. Overhead hooks are arranged for support of blocks, tackles, and other gear such as boatswains chairs. The area is used for the practical seamanship component of the seamanship course and also as a support facility for the training vessels and general complex. Wall displays are arranged on rope and wire splicing, blocks, tackles, life saving equipment, distress equipment, and rules of the road (Fig. 8). Drums for storage of rope and wire used during the course are arranged beneath one wall bench.

The Electronic Aids Laboratory. Figures 9 and 10 show the layout. The room is outfitted for instruction in the use of aids in navigation and fish detection for both the navigation and marine electronics courses; the arrangement is especially suitable for use by students on an individual basis in order to gain experience with the many items of equipment through the use of simulators. Important items of equipment include a Simrad fish finder with simulator input presentation on both paper and C.R.T. displays, an APN 9 Loran using a live signal from a roof antenna, a Kelvin Hughes digital readout Loran with simulator input, a Decca Navigator Mark 12 with simulator input, a radar trainer/simulator using 16mm film exercises, a short wave radio, an R.D.F. and the base station for a private V.H.F. radio network for contact with training vessels.

The Radar Room is used in conjunction with the electronic aids laboratory for the main electronics course (Fig. 11). It contains two radar sets, fed from a live antenna mounted on the outside tower, used to demonstrate the functions of various components, trouble shooting and correct tuning. A Basdic sonar unit is fitted through the floor with the transducer head projecting into the seamanship laboratory, and is used to demonstrate the principles of sonar operation.

The Lecture Room is illustrated in Figure 12 and has accommodation for a maximum of forty students. A complete range of visual aids equipment is provided, including a 16mm film projector, a carousel slide

projector, and an overhead projector. Wall displays illustrate layouts of various fishing vessel types; a combination of half model and lines plan demonstrates the delineation of a vessel's hull by a drawing.

The Navigation Laboratory is shown in Figure 13. It contains chart tables for fifteen students; up to an additional ten students can be accommodated in one section by use of additional tables in the meteorological and electronic aids laboratories. Equipment available includes a miniature planetarium and solar system models, sextants, pelorus, chronometers, and a deviascope. This room is used for both navigation courses, the meteorology course, and also for laboratory work in the vessel technology course. In addition, it serves as a second lecture room when needed.

The Meteorology Laboratory is combined with office accommodations for one faculty member. It contains the usual meteorological equipment found aboard a selected weather reporting vessel of the World Meteorological Organization, including a barograph, thermograph, barometers, outside thermometers, maximum and minimum thermometers, and displays for the tower-mounted anemometer and wind direction indicator.

#### BUILDING NUMBER 2

This structure is arranged to provide an area containing teaching laboratories requiring workshop type layout. It has adequate height over the working areas for lifting machinery and hanging nets, with a lifting door to provide access for the largest equipment used. As shown in Figure 14, which is a view from the entrance door, a twelve-foot loft runs along the eastern (rear) wall to provide storage for fishing gear supplies and the purse seine net, together with a carpenter shop. A faculty office is built above the tool room and welding shop, providing an excellent view of activities on the laboratory floor below. To assist with storage of the purse seine, a power block (shown at the top of Fig. 14) is operated from the engineering laboratory hydraulic system; this power block is also used aboard the training vessel when purse seining fishing operations are undertaken.

Although the engineering technology and fishing gear laboratories are each allocated half the available floor area, main facilities are placed at each end of the building on order to allow a clear space behind the lifting door, for loading and off loading. Where necessary, student activities in either laboratory expand

into this space. A complete mast, boom, winch and gallows assembly (Fig. 16) is arranged at the center rear of the building (Fig. 17). This equipment is used during seamanship classes to teach correct operation of running lines and deck equipment, and during the engineering courses to demonstrate the application of hydraulics to fishing vessel deck machinery.

The Fishing Gear Laboratory is used during the introductory shipboard work course, and the two fishing gear courses. In addition, it provides support activities for training vessel operations. A general view of the area is shown in Figures 14 and 15. Lowering spars are fitted for hanging web used in initial teaching of twinwork; wall displays show items of equipment used in net construction and repair, and plans of a wide range of nets. Tricing hooks are closely spaced along the walls for stretching out lines and net sections. A wide range of model nets, most of them made by students as part of their coursework, are strung above the area (Fig. 17). Other models of fishing gear are wall mounted or table mounted, such as the trap net shown in Figure 18. Two riggers' vises are mounted for wire splicing activities.

The Engineering Technology Laboratory. The main area as shown in Figure 19 contains a range of diesel engines, including all makes most commonly used in the industry. Two cut-away demonstration engines, a 6-71 GM, and a Caterpillar turbo-charged marine diesel, are available. Working diesel engines include two 6-71 GM models, one with a complete marine gear and front power-takeoff, one Caterpillar D-330, one Cummins C-160, one Superior four cylinder, one Lister SL-1. A self-contained cooling system is arranged for each engine with a portable fuel tank and portable exhaust system to the outside, which can be taken to any engine by use of an overhead boom. A work bench, with storage below for demonstration engine parts, runs along the north wall and provides the usual shop equipment, including drill press, grinder and vises. Wall displays are arranged showing the operation of marine diesels. All engines are used in the first marine engineering technology course.

A complete system for teaching hydraulics is arranged in the northeastern corner (Fig. 20). Hydraulic pumps, powered either by an electric motor or the Lister diesel, provide power for the mast and boom rig, the power block, and a work bench having five sets of pressure and return line outlets. The self-draining bench provides a facility for the assembly of various hydraulic systems by students during the second engineering technology course.

Two ton and a half-ton hoists are arranged on a traveling beam to provide lifting facilities covering the laboratory floor area. The laboratory is used also as a support facility for the buildings and training vessels.

The Welding Shop contains gas welding and burning equipment together with two electric welding sets for steel and aluminum. Space is available for four students, and the room is used also as a support facility (Fig. 21).

The Tool Room. This locked area contains storage arrangements for all tools, test equipment, and other expensive and delicate items used in the engineering technology courses and in support activities (Fig. 22).

The Carpenter Shop. This contains a band saw, table saw, bench and vise, together with a wide range of wood-working tools in addition to wood storage. It is used as a support facility for the laboratories and training vessels (Fig. 23).

Fishing Gear Storage. This area contains a box for rat-proof storage of the purse seine, floats and other gear (Fig. 24). A locked area shown in Figure 25 is arranged for the storage of "ready-use" twine in bins, and fishing gear hardware and supplies, together with baled twine and rope used in the construction of nets and general twine work. Additional storage for baled twine is provided on the roof of the faculty office.

90/94

84

## CHAPTER VII

### TRAINING VESSELS

The principal vessel facility used throughout the program development has been the 47 foot "Gail Ann." In the beginning stages, immediate acquisition of a vessel was felt to be particularly important as the main laboratory facilities were in a rural rather than a waterfront setting. The choice of the particular vessel was governed, at that time, by immediate availability rather than particular size and characteristics, although it was found to have been a sound decision. It proved possible to develop the vessel into a facility found ideal for training purposes, and an account of the development process is provided in a later section of this chapter.

Although the "Gail Ann" has proved entirely suitable as a training facility, experience indicated that she is somewhat small for operation in offshore conditions during the winter months, which form much of the academic year. For offshore work required during the final semester course in fishing operations, a vessel of commercial type has been used successfully. This is a 57-foot stern trawler operated by the University's Marine Experiment Station, which has been made available two days each week during the spring semesters in 1970 through 1972 on a charter basis.

Several small craft have been in use either associated with the various fishing operations conducted aboard the "Gail Ann" or for other training activities. These include:

1. An 18-foot flat-bottom work skiff used during purse seining operations.
2. Two 5-bed (16-foot bottom length) standard Nova Scotia dories. These are the small lifeboats normally carried aboard New England fishing vessels, and have been used for training in launching, handling, and rescue operations from small boats.
3. A 30-foot double-ended surf boat used by students for rowing, handling and small projects.

During the second and third years of the program, a 21-foot diesel-powered, fiber glass craft was provided as a general purpose work boat, and was also made available

95/98



for student use in small projects without faculty aboard. This practice was stopped, however, because of damage caused due to misuse by students. The vessel, used only intermittently, proved troublesome to maintain and was withdrawn from service. Although the idea appeared sound in principle, the practical difficulties indicated that such a facility should not be made available to students in this type of program.

#### Development of Training Vessel "Gail Ann"

This 47-foot vessel had originally been a gift to the University for use in short-range oceanographic research work. She was built as a "trawler" type yacht on a standard Connecticut fishing vessel hull to a high specification and standard of finish. Her layout was not suitable for that work so the University's Graduate School of Oceanography was willing to make the vessel available, on a charter basis, for use in program activities following completion of initial modifications to make her suitable for a training vessel role. Extensive first-stage modifications were undertaken in a local shipyard during the winter of 1967-68 and she entered service in March 1968. Further modifications to the vessel were made in two stages during the period 1968 to 1970, resulting in an extremely versatile facility, which proved relatively inexpensive to operate.

While used for oceanographic work, "Gail Ann" appeared as shown in Figure 26. The deckhouse was placed above the engine room with a forward trunk above a galley and living quarters, and an after trunk over a two-berth stateroom with extensive private facilities, including a shower and head. A light mast was rigged forward of the wheelhouse. The vessel was outfitted to yacht requirements rather than for commercial use, so that on modification much of the equipment required replacement, or was only suitable for retention in a back-up role.

The main power unit, a GM 4-71 diesel developing 96 BHP at 1800 rpm, was considered suitable for retention, as also was the 12 volt d.c. electrical system. Although a radar and depth indicator were fitted, they were not commercial units so could be used only for back-up duty. The radio telephone unit was suitable, at this stage, as the primary communication unit.

First Stage of Modification. The principal task was to modify "Gail Ann's" arrangement to make her suitable for undertaking one fishing method. The vessel's layout with living quarters forward and wheelhouse amidships

above the engine room meant that by removing the after trunk, shortening the wheelhouse, and changing the after stateroom into a hold space, she could be converted in a reasonably simple manner for stern trawling from the after deck. Initially, therefore, it was decided to modify for stern trawling using a transversely mounted winch so that the deck was clear of running wires. This arrangement would also allow the later addition of equipment for purse seining and multi-rig trawling.

Extensive modifications to the engineering and electrical arrangements were also necessary at that time. A hydraulic drive was chosen for deck machinery so that later additions could be easily arranged. In order to operate the range of electrical and electronic equipment required for training purposes, an a.c. generator was installed with a complete system. A larger and more extensive bilge pumping arrangement was added together with a modified fresh-water system.

In order to place the vessel in service at the earliest possible date, only modifications considered essential were undertaken, and these included:

- Removal of after trunk.
- Shorten deckhouse, some 2 feet at the after end.
- Construction of hold space below after deck, with hatch.
- Reconstruction of after deck with sheathing over surface of working deck and around the stern.
- Rearrangement and modification of bulkheads as needed to make them essentially watertight.
- Installation of mast and boom immediately abaft deckhouse, with falls and whip, and boom topping by use of the winch warping head.
- Installation of winch immediately abaft mast.
- Installation of gallows and hydraulic net drum aft.
- Installation of hydraulic system driven by front end power-take-off clutched from engine.
- Installation of 6.5 kw a.c. generator and electrical system.
- Modification of d.c. electrical system.
- Modification of engine exhaust systems.
- Installation of bilge pumping arrangement using an a.c. pump and manifold to engine room, hold and lazarette.
- Installation of fresh-water tank forward with associated system.
- Rearrangement of wheelhouse to provide for open layout with adequate chart table for student use.

- Installation of commercial electronic units including radar, paper depth recorder, and loran set.
- Addition of two liferafts and complete outfit of safety equipment.

When placed in service, "Gail Ann" was equipped to undertake stern drum trawling using a bottom trawl; by removing the drum and modifying the fishing arrangement, she was also used for stern trawling with quarter ropes. It was therefore possible to undertake the usual method of trawl handling aboard New England draggers, but carried out over the stern rather than over the side. Following this first stage of modification, "Gail Ann" appeared as illustrated in Figure 27.

Experience was gained in operation of the vessel with this configuration until the end of the 1968-69 academic year. It was found necessary to provide for constant heat during the winter months to protect the engineering systems and to prevent malfunction of electronic equipment. Two electric heaters were installed from the 110 volt a.c. electrical system, powered by the generator or from a shore supply when at dockside. A commercial fishscope providing C.R.T. display was added to the complement of electronic equipment during 1969.

Second Stage of Modification. For the fall semester of 1969 and the spring semester of 1970, modifications were made to allow purse seining and twin-rig trawling to be undertaken. At the same time additional hydraulic equipment and a CRT Sonar were added, together with a VHF radio that provided direct communication on a private network with the base at Wickford.

Modifications for purse seining included the fabrication and installation of a portable davit with blocks, purse line drum, and purse ring tray. In addition, a new, longer boom was added with a mast-mounted hydraulic topping winch. The boom was arranged to carry a removable hydraulic power block and a falls with two whips for gear handling. A small boom for ring hoisting was arranged from the mast in line with the purse davit. At this time, an 18-foot workboat was obtained and outfitted with a 20 hp outboard motor and cleats for use as a seine skiff.

For twin-rig trawling, two booms were fabricated to mount each side of the mast with the necessary topping and staying arrangements.

All deck and fishing equipment except the main winch was fabricated to be portable in order to allow simple

and quick change-over between fishing methods as needed. Figure 28 illustrates "Gail Ann" with the larger boom arrangement, and Figure 29 shows the vessel purse seining (the funnel was added during the third stage of modifications). Experience during 1969 and 1970 confirmed the efficiency of these arrangements.

Third Stage of Modifications. Work undertaken during this stage was carried out during 1970 and 1971 and involved the final changes found desirable to achieve a high class facility with the addition of a midwater trawling capability.

During this period, an automatic fire extinguishing system was installed in the engine room, together with a bilge water warning arrangement, and a small funnel was fabricated to provide additional protection to the wheelhouse-mounted silencer. A complete renovation of the electrical systems with central circuit breakers was arranged to provide a more efficient teaching aid.

Very little work was needed to prepare for midwater trawling capabilities, and included the modification of the gallows structures to permit a more efficient system of quarter block layout. Plans are completed to install a line hauler, for long line or pot operations, and a gillnet power block arrangement during the summer of 1972, so that these fishing methods can be undertaken in a more efficient and commercial manner than has been possible previously. Both items will be hydraulically powered and arranged to hang from the existing small mast-mounted purse ring boom as needed.

A listing of the principal specifications and equipment aboard "Gail Ann" will be found in Appendix M.

#### Operation of the Training Vessel "Gail Ann"

In the curriculum as originally designed, no allowance had been made for the regular use of classes aboard a training vessel; it had been assumed that some time would be spent aboard the vessel during the seamanship and fishing gear courses, and more extensive voyages would be undertaken outside normal class hours.

Experience with teaching work during the first semester of program operations showed that the time available would not permit use of the vessel during class hours, as all laboratory time was taken up with skill development aspects of the courses. It was concluded, therefore, that the vessel should be operated during afternoons, and students placed aboard on a

rotational basis outside their scheduled class sessions.

The vessel was placed in service in mid-March 1967, and the operational arrangements worked well that year with the majority of students taking advantage of the sea-time opportunity. During the following academic year, a similar arrangement was used, with the time available being divided between the first and second year students. However, after the first few weeks of classes in the fall semester, about one-third of the freshmen students were failing to attend the training vessel voyages. An investigation indicated that these students did not feel obliged to put in the vessel time as it was not an official requirement for the program.

As a short-term answer to the problem, the vessel time was associated with the fishing gear courses and 25 percent of the grade for those courses allocated to performance aboard the vessel. This action led to only a slight improvement in attendance, a number of students being prepared to forego the grading benefit for additional free time.

As a long-term solution, it was decided to introduce required courses in which all student time was spent aboard the training vessel. These were included in the first curriculum revision as a series of three courses entitled "Shipboard Work" and involving one or two 3-hour periods a week during each of the first three semesters. The training vessel was, in practice, operated as a "floating laboratory" for these courses, and a more complete account of the operational arrangement will be found later in this section.

Registration. Before commencing operations with the vessel, an investigation was made to determine what registration arrangements would be required. While privately owned, "Gail Ann" had been registered as a yacht, but this had been withdrawn when she was acquired by the University. Two possible requirements emerged, either official registration, or licensing with the State of Rhode Island Motor Vehicle Registry (who were responsible for licensing of unregistered craft within the state). Following meetings with the relevant bodies, it was found necessary to register or license "Gail Ann" as she was operated by a state institution.

Inspection. On studying the Coast Guard requirements for vessel inspection, it appeared that "Gail Ann" would be classed as an uninspected vessel due to her size; also, no regulations were found to exist for inspection due to her use. It was necessary, therefore, only to

104/105

100

meet the Coast Guard requirements for uninspected vessels, which covered, primarily, lifesaving and firefighting equipment. Several meetings were held with the responsible Coast Guard Marine Inspection Officer in Providence, Rhode Island, who confirmed the vessel's status; however, as a courtesy, liaison has been maintained with the Coast Guard Inspection Office, and Marine Inspection personnel have visited the vessel, their visits proving extremely helpful in suggesting ways in which safety and maintenance of the vessel could be improved.

Although the vessel is uninspected, considerable care has been taken to ensure that safety and firefighting equipment is fitted in excess of the requirements, and equivalent to that carried aboard larger vessels. Efforts have been made to ensure maintenance of the vessel and her equipment is of the highest possible standard. A listing of safety equipment is included in Appendix M.

Insurance. Standard marine Protection and Indemnity insurance (P&I) is carried for the vessel's operations in the amount of \$300,000, to cover any claims from persons aboard or for any damage to property or other vessels. It was possible to obtain favorable consideration from the company by restricting the operational area and number of days at sea each year to those used during training voyages, by establishing a high standard of maintenance, lifesaving and firefighting equipment, and by placing responsibility for the vessel's operation in the hands of an ex-merchant marine shipmaster. "Gail Ann" is classed for insurance purposes as a research vessel, with the number of persons aboard restricted to twelve, this being sufficient for the expected use.

The operational area or number of persons aboard can easily be extended by the use of a waiver for each occasion, or by payment of a small additional premium to cover any extended use. With this arrangement, students under instruction are permitted to play a full part in operation of the vessel under the supervision of an instructor carried aboard.

The University has not considered it necessary to carry hull insurance on the vessel, preferring to remain self-insured in the event of any loss. Expensive equipment placed aboard, such as the winch and electronic aids, has been covered by insurance. This is now being discontinued due to the high cost and the very low value placed on the equipment by the insurance company, so that in the event of a loss only a small fraction of the replacement cost would be recovered.

Licensing of Personnel. "Gail Ann" is below the minimum size of vessel requiring a Coast Guard license for the operator; also, no requirement exists for a licensed operator because of her use. It is to be expected, however, that in the event of an accident, any official investigation would be strongly critical if highly qualified personnel were not responsible for the vessel's operation. For this reason, overall responsibility for operation of "Gail Ann" is taken by an ex-merchant marine shipmaster; other personnel involved in teaching work aboard the vessel carry lesser licenses, or are highly experience in the operation of fishing vessels and other craft of similar size.

Base for Operations. The decision regarding a base of operations for the training vessel was made in conjunction with that regarding location of the total facilities, as reported in Chapter V.

From the viewpoint of vessel operations, it was important that the vessel be able to carry out the training exercises and fishing activities on a consistent basis throughout the year, in all but extreme weather conditions. At the same time it was necessary that fishing grounds, having an adequate quantity and range of fish species suitable for all fishing operations undertaken, were within a short distance so that best use could be made of the scheduled vessel time. Services required at the berth were fuel, water, and electric power.

The port of Wickford was found to meet all these requirements, and has proved a most suitable base for training vessel operations. The berth itself is sheltered, allowing the vessel to leave and return safely in all weather while handled by students, and the necessary facilities are at dockside. Narragansett Bay contains a number of large islands so that it is always possible to obtain sheltered waters, in a lee, if needed. Fish stocks within the Bay change seasonally, providing both the bottom and pelagic species necessary for all fishing operations undertaken during the program. A number of excellent fishing areas are within a short passage time, and, if desired, a bottom trawl can be set directly outside the breakwater, only two or three minutes after leaving the berth.

Operating Arrangement. The vessel has been scheduled for classes in the same manner as other laboratories, with regular operating hours each week. Normal class sessions extended for three hours in either morning or afternoon, and the vessel operated as planned irrespective of weather conditions except in extreme circumstances,

such as storm conditions or when harbor ice was too thick for navigation. Even during the mid-winter months, it was unusual for weather to delay sailing for more than five percent of the scheduled trips, and on these occasions students were employed on maintenance work.

It was found unnecessary to employ a permanent skipper for "Gail Ann," instructors assigned to each shipboard work course being responsible for the vessel's operation during all activities throughout the course. In order to ensure that all students received similar instruction and experience, a particular faculty member was assigned to teach all sections of the same course.

Students undertook all daily checks and maintenance, including clean-up duties, as part of their course work; periodic maintenance activities were undertaken by the technician with the assistance and guidance of faculty members in the various areas of competence, such as engineering, electronics, fishing operations, and vessel technology. The wide range of support facilities available from the laboratories made it possible for program personnel to carry out all work other than that of a major nature or requiring haul-out facilities. Following the initial modifications to the vessel, all equipment for the various fishing operations has been built and installed by the faculty and the technician. All unrigging and rigging of equipment aboard the vessel when changing fishing methods or fishing gear were carried out by students under guidance of the instructor, as regular course activities.

A standard yearly contract has been maintained with the shipyard, from whom the facilities were rented. This covers use of the marine railway, including two haul-outs annually for routine below water hull maintenance, together with any emergency hauling needed as a result of problems, such as a net in the wheel and propeller or shaft damage. Similar contracts have been used with a local engine shop and an electronics company to cover parts and major repairs, which would be too time consuming for department personnel. Care has been taken to establish a very high maintenance standard, so that only six classes have been cancelled during the five years of operation as a result of vessel problems.

Course Arrangement. Activities during the three shipboard work courses were arranged so that students first learned the necessary procedures for handling the vessel and her equipment, and then gained an introduction to the practical operation of a wide range of commercial fishing methods. A full description of the work covered



during each course will be found in Appendix G, and only a brief outline is included here to illustrate the principles of the arrangement.

Shipboard Work I introduced students to aboard vessel work, and enabled them to gain experience in the routine operation and maintenance of the various equipment and in handling the vessel under a wide range of situations. Great emphasis was placed on safety precautions, action during possible emergency situations, and a sound seamanlike approach to the performance of all activities. The work included standard maritime orders and procedures in addition to fishing vessel procedures (which are usually more relaxed) for the benefit of students wishing to enter other sections of marine activities. Students were introduced to bottom trawling during the final weeks of this course.

Shipboard Work II concentrated on bottom trawling operations, every session being spent fishing with either the stern drum or quarter rope handling arrangements. Emphasis was placed on correct procedures for handling the vessel, equipment, and net while on passage and when fishing. All students had the opportunity to act as skipper, mate, engineer, navigator, and deckhand on a rotational basis, and were responsible for all aspects of the vessel's operation under the instructor's guidance, as needed. This arrangement proved extremely effective in permitting students to gain a wide range of experience in the various tasks involved in the operation of a fishing vessel, in responsibility and decision making, and in working as a "team" member of a crew. Appendix M includes a section entitled "A Day on the GAIL ANN," an account of the arrangement as seen through the eyes of a student.

Shipboard Work III was built upon activities of the previous two courses. Students were again made responsible for all aspects of the vessel's operation, in the same manner as during the previous course, and gained experience in purse seining, twin-rig trawling and mid-water trawling. In addition, net telemetry equipment was used to illustrate the change in geometry of a bottom trawl under various fishing conditions.

Student Numbers. The optimum section size for the on-board vessel courses was found to be six students, assigned as skipper, mate, engineer, navigator, and two deckhands. With this number, all students could be kept fully occupied on their assigned activities throughout the trips. An additional student could be carried as an extra deckhand bringing the section size to seven, or a

deckhand position could be omitted, without seriously affecting the value of the experience. It was found that if more than seven working students were carried aboard at one time, the vessel became overcrowded, resulting in possible danger from running wires and equipment under the confined conditions. If it was imperative to allocate more than seven students to a section (as happened during the final year) then a rotation system was used with the excess students being occupied ashore in fishing gear activities, or in boatwork. Chapter III explains how this restriction on section size for training vessel courses affected the staffing requirements.

Safety. Great emphasis was placed on safety throughout the vessel operations. In addition to the provision of a wide range of lifesaving and fire-fighting equipment (Appendix M), side rails were rigged each side of the open after deck whenever fishing arrangements permitted. The a.c. and d.c. electrical systems were arranged for entirely independent operation, with basic navigational aids such as radar and depth sounders being duplicated; instruments were powered from both a.c. and d.c. systems so that if one system should fail, a back-up unit was available.

Instruction in various emergency procedures, such as man overboard, liferaft handling, fire-fighting, and abandon ship, was provided and each student allocated duties in the event of a serious emergency.

Many possible dangers existed when students handled fishing gear, so that constant attention was given to safety precautions when using the deck machinery, running wires, when hauling and lifting the nets, and when freeing gear following a foul or hang-up. Although the deck machinery was operated in a true commercial manner, a master control position was arranged at the after end of the deckhouse, and the student engineer stationed there; at all times while the hydraulic equipment was in operation, it was his responsibility to be alert to possible danger and immediately cut power by means of the master control valves. On a number of occasions, prompt cutting of power from this position saved serious injury, and such an arrangement is considered a necessity aboard a training vessel where operations are undertaken by students under instruction.

During the five years' experience in teaching aboard the vessel, no injury more serious than a small cut or graze has been experienced, and this must be attributed largely to the great emphasis placed on

safety during all vessel operations.

Operating Cost. The annual operating cost of "Gail Ann" is approximately \$6,600, arising under the various headings below:

Fuel	\$ 400
Hull maintenance	3,000
Engineering maintenance	300
Electronics maintenance	200
Supplies	200
Insurance	<u>2,500</u>
Total	\$6,600

Use of Vessel for Fishing Operations Course. During the final semester of the program, commercial fishing trips were undertaken by students each week in connection with the Fishing Operations course, for which a full description of activities is included in Appendix G. This course emphasized fishing operations under commercial conditions, with full-day trips, sometimes extending for twenty-four hours, to fishing grounds adjacent to the Rhode Island coast.

As the course was designed to bring together work of the various subject areas applied to actual commercial fishing operations and the work of a fishing vessel skipper, it was placed in the final semester of the program, running from the beginning of February through mid-May. This time coincided with the worst weather conditions found during the year on the fishing grounds. Although "Gail Ann" was used for the first two years of course operation, it was necessary to cancel some fifty percent of the possible trips because of weather; in addition considerable care was found to be necessary when working offshore. This meant that weather rather than representative commercial conditions became the main factor controlling operations, and the training was not entirely realistic. Problems also arose due to the distance between the vessel's base and the fishing grounds, resulting in excessive passage time when compared with available fishing time. On a number of occasions each year the vessel was operated from the fishing port of Point Judith, some two hours' steaming time nearer the grounds, but this led to scheduling problems with the other shipboard work courses, as on several occasions weather prevented the vessel leaving Point Judith on the return trip to Wickford.

## Operation of 57-Foot Commercial Vessel

In order to assess the effectiveness of a bigger vessel in handling larger student sections during the shipboard work courses and for offshore work during the Fishing Operations course, it was decided in 1970 to attempt the charter (for one year) of a vessel between 60 and 70 feet in length, suitable for use both from Wickford and Point Judith. Experience with such a vessel was also expected to provide guidance as to the operating cost of a larger vessel compared with the "Gail Ann."

At the time this action was decided, a vessel considered ideal for the purpose was available, but it was sold before a charter could be negotiated. Other vessels were inspected for possible use, but none were considered suitable either due to their condition, the charter price involved, or because their equipment was considered insufficient or inferior.

At this time, the University's Marine Experiment Station offered their 57-foot vessel "La Nina" for use during the Fishing Operations course on a very favorable charter basis. The offer was accepted and attempts to arrange a long-term charter of a commercial vessel dropped.

The "La Nina" was used during the final three years of the project for the Fishing Operations course only. Based in the Point Judith area, she was convenient to the fishing grounds and has proved suitable for the purpose. Weather has been a problem, as expected, but the vessel was able to operate under all conditions in which commercial vessels sailed; between 20 and 22 trips each year were made, some 80 percent of the possible occasions. The instructor assigned to the course was an experienced Point Judith fishing vessel owner/skipper.

Particulars of the vessel are included in Appendix M. Built in Chile to a standard MARCO design, she is outfitted as a stern trawler with hydraulic deck equipment and a suitable range of electronic navigation and fishing aids. Being a commercial vessel, the equipment, outfit and layout have provided final semester students with a good introduction to commercial operations. However, this experience has shown that a commercial vessel of this type would not be suitable for the initial training of inexperienced students during the earlier courses without considerable modification to improve safety, and that it would be necessary for a second instructor to be carried.

During the Fishing Operations course, "La Nina" has been operated as a commercial fishing vessel in association with the Point Judith Fishermen's Cooperative. Supplies, including ice, were purchased from the cooperative, and the fish landed and sold in the normal commercial manner. This arrangement was found to provide students with excellent training in fisheries business practices. In addition there was usually a small cash surplus available which assisted in providing wire, fish baskets, and other such items used during the classes.

Students carried out the duties of skipper on a rotational basis, with the remainder of each section acting as crew. The student skipper was responsible for all aspects of the operation, including decision making regarding fishing grounds, rigging of gear, sailing times and control of the voyage. Guidance of the instructor was restricted to a minimum in order that students experienced the responsibilities involved. Working in this manner, and in order that each student could experience at least one trip as skipper, within the time available, a maximum section size of ten was possible. The instructor preferred to restrict the number aboard to eight at one time, in order that everyone was fully occupied.

#### Choosing and Outfitting a Training Vessel

Although two vessels were used during the project, this was necessary only because of the small size of "Gail Ann." There appears no reason why a single vessel of a suitable size should not be equally effective in all courses during the program. With the entry of forty students a year, such a vessel would be in use daily for a five-day week during the school year, because of the number of sections involved.

When establishing a new program, it would be most unusual if sufficient funds were available to purchase a training vessel out-right. At the present time a vessel of the type outlined in this section could be expected to cost around \$150,000, and prices are increasing up to ten percent annually. In the long term, a vessel designed and built for the purpose has obvious advantages, but it is felt that such efforts are best delayed so that experience gained from several years of vessel operations can be incorporated. An alternative is to charter, to obtain a surplus Army, Navy, or Coast Guard vessel, or attempt to have a suitable vessel donated. Whichever method is chosen, the most important considerations are that the vessel can be arranged to undertake the necessary wide range of fishing operations

in a reasonably commercial manner, and her equipment is representative of commercial practice.

The only advantages of a donated or ex-service vessel are that no annual charter or initial capital expense is involved, and there is usually no objection, in principle, to conversion of the vessel to suit the training needs. Unfortunately, former government vessels were not designed with a commercial purpose in mind, and their layout and equipment are rarely of a type or make used in commercial fishing activities. They can therefore be expected to prove expensive to convert, expensive to operate, and often fail to provide a realistic training situation.

Many vessels available for donation from private sources are of yacht type, with a hull form making them unsuitable for conversion to a training vessel for commercial fisheries. Others may have a suitable hull form, but their construction is too light to stand the loads and strains experienced when fishing.

Commercial vessels are rarely offered for donation, but may be available on a reasonable charter basis if temporarily surplus to the owner's requirements due to fluctuations in fishing activities. Most commercial vessels are not entirely suitable, as they stand, for training activities, especially with inexperienced students. In general, the large hold space is unnecessary for the small catches brought aboard during the short trips, and insufficient space is available in the wheelhouse and engine room for training purposes. However, if a vessel is available on a reasonably long-term basis, it should be possible to modify the layout and equipment for training purposes without incurring excessive expenditures.

When considering size, the primary concern is that the vessel be large enough to work nearby fishing grounds in all weather in which local vessels operate. All other considerations suggest that as small a vessel as practicable be chosen. Operating costs for vessel operation rise rapidly with length so that, typically, a 60-foot vessel costs nearly twice as much to operate each year as a 45-foot vessel, whereas a vessel 75 feet in length costs over three times as much. If the vessel is large enough to require a full-time skipper in order to ensure adequate maintenance and preparation for classes, then this represents an additional cost.

A reasonable compromise for use with most programs would appear to be a vessel of around 60 feet in length;

this size craft would not require a permanent crew, and could be operated satisfactorily by individual course instructors. It should be possible to work with ten students aboard at one time, so permitting a favorable section size for use in courses. A vessel this size can be expected to be classed as an "Uninspected Vessel" by the U.S. Coast Guard, when used as a floating laboratory for day trips without student overnight berthing (Appendix M).

Vessels having a wheelhouse forward with an after working deck appear to offer considerable advantages for training purposes. This arrangement offers a better protected and steadier working platform area for students than does a wheelhouse aft layout; it also permits a vessel to be rigged in a reasonably simple manner to undertake all the common fishing methods. It is desirable that the wheelhouse be an open plan arrangement with adequate windows and a door leading directly to the working deck, so an instructor has rapid access to either area.

The main engine should be of a type and make used in the local commercial fishing industry, in order to provide students with a realistic learning experience. High power is unnecessary and can prove dangerous in a training situation; for a vessel of about 60 feet in length, a main engine power of 250 to 300 hp is considered adequate.

Once a particular vessel has been selected, its conversion and outfitting for a training role represent a reasonably straight-forward, although expensive, undertaking. Appendix M includes an outline specification of "Gail Ann" that will provide a guide to the type of equipment found effective.

As a general rule, the vessel's layout should be open and uncluttered. A wide selection of equipment representative of commercial practice should be provided and arranged in a straight-forward manner. It is particularly important that all equipment aboard be of commercial quality, and any existing units of yacht or service origin be discarded if unrepresentative.

In order to be used successfully for a Fishing Operations course, requiring realistic commercial fishing, it is important that the vessel be outfitted to undertake one method of fishing in a true commercial manner. The method chosen should be that used by local fishing fleets at the appropriate season. In addition, the vessel should be rigged to allow a realistic demonstration

of all other important fishing methods.

The use of hydraulic power for deck machinery has been found to permit a particularly flexible arrangement, as it is possible to change between a number of different units at a single outlet. If a vessel has an existing commercially realistic winch powered in another manner, the hydraulic system can be added. By the use of several pumps and by-pass arrangements, it is possible to design the hydraulics to provide either full or reduced power to units. A reduced power arrangement will prove valuable during the early student training as the deck machinery units can stall instead of carrying away fixtures or wires when wrongly operated. Whatever arrangement is provided for powering equipment used during fishing operations, it has been found a necessary safety precaution that power, especially to the winch, can be instantaneously cut-off from a central position.

The usual d.c. battery system with main engine-powered generator, found aboard a commercial vessel of appropriate size, will often have insufficient capacity to power the wide range of electrical and electronic equipment that should be fitted to a training vessel. In addition to providing a valuable teaching aid, a 110 volt a.c. system powered from a separate diesel-driven generator will permit the use of electric heat, and an electric bilge pumping system. It will also enable much standard electrical equipment to be used aboard, and provide primary power for principal electronic aids. Back-up units for all important systems should be operated from the d.c. system, in case of generator malfunction; such aids should include bilge pumps, a small radar, and a depth sounder.

Safety Equipment. An uninspected vessel of around 60 feet in length is required to meet specific standards regarding lifesaving and fire-fighting equipment. In general, these requirements should be considered an absolute minimum, and equipment to a considerably higher standard installed. In addition to the usual life rings, a combined light/smoke man-overboard float is considered essential; inflatable liferafts should be available for all persons normally aboard; the use of two rafts with lower capacity (rather than a single unit) will provide an additional safety factor. Appropriate fire extinguishers, mounted in convenient positions, should be carried in every space, together with a CO<sub>2</sub> smothering system for the engine room. A bilge warning system will permit immediate notice of taking-on water. The a.c. electrical system will permit the use of a high-powered main bilge pump, which can be backed up by d.c. pumps



and a hand pump; one d.c. pump should be arranged for automatic operation with any rise in bilge water level. The installation of VHF facilities, providing direct communication between the vessel and a base transmitter on a private frequency, is a particularly important safety consideration.

Operating Cost. Annual operating costs for a vessel of the type and size outlined can be expected to range between \$12,000 and \$14,000.

## CHAPTER VIII

### EVALUATION

In general, the United States Commercial Fishing Industry has no clearly established standards applicable to various classes of employees, especially for vessel crews. Ability to do the job appears to be the criterion used in the hiring and promotion of crew members, and by tradition a young man enters the industry at the lowest level and works his way upwards as he gains experience and exhibits ability. A variation of skill level and need is found between fishermen working in different areas of the country, and within the same area, fishery and port. As the success of a fishing vessel is measured by the gross earnings, which are heavily dependent on the amount of fish brought to port, it follows naturally that the skippers are classed as top, average or poor, depending on their ability to find and catch fish.

Certain officers aboard larger fishing vessels (over 200 gross tons) are required to hold Coast Guard licenses as engineer, mate, or skipper of an uninspected vessel, so that some proficiency level is indicated by examination requirements for these licenses. However, the requirements for Coast Guard licenses are concerned primarily with safety considerations and include engineering knowledge or elementary seamanship and navigation. No attention is given to a skipper's fishing ability. The majority of commercial fishing vessels are of insufficient size to require licensed personnel, and no minimum level of knowledge or ability is required by their skippers. It is possible for a person with no previous knowledge of the sea or fish to purchase and legally operate a fishing vessel below the minimum size requiring licensed personnel, providing no passengers are carried for hire.

Although Unions, Vessel Owners Associations, Cooperatives, and similar organizations exist in many fishing ports, their concern is primarily with operational and working agreements rather than with establishing any proficiency standards for personnel.

As a result of this almost complete lack of existing standards to be met by graduates, it was necessary to develop suitable levels of skill proficiency and knowledge that would enable the program aims to be met, and then provide a curriculum to meet these requirements. Once this operation was completed, it was important to ensure that the established requirements were appropriate and the program, as developed, was satisfactory in meeting

the needs of all parties concerned.

In order to accomplish this, a constant process of self evaluation was used throughout the program. In previous chapters, descriptions have been included of the various procedures used and findings of evaluative activities undertaken as a part of project work. Members of the Advisory Council and the fishing industry, particularly fishermen from Point Judith, have cooperated fully in these activities.

A more formal internal evaluation of the program's effectiveness was included in the Department of Fisheries and Marine Technology input for a University-wide self study in 1971.

Throughout the project, considerable assistance has been gained from evaluative actions of a number of agencies, which have included the United States Coast Guard, Sea Grant Program Site Visit Teams, and personnel of the New England Resource Center for Occupational Education.

#### Acceptance by the Industry

Commercial fishing has no history or experience in using persons who have received education and training preparing them for work in the industry. Ability has become the paramount factor, therefore, on which anyone associated with the industry is judged. Previous experience of the project director had indicated that it was necessary for each faculty member to demonstrate professional competence in his field to the industry. This was found to be most important during the early years of the project when most staff were not local people and therefore unknown quantities so far as the fishermen were concerned. Discussions with industry members of the Advisory Council indicated that direct connection between the project and industry could hasten the acceptance process and also provide the two-way communication needed to develop the curriculum.

This direct industry contact was established through the appointment of local successful skippers to the program faculty as reported in Chapter III. Mutual confidence was established quickly between the existing faculty and the skippers, who maintained their connections with the industry by retaining vessel ownership and membership in the Point Judith Fishermen's Cooperative. The success of this approach led to the later appointment of a top owner/skipper from New Bedford.

Being a part of the industry, these men moved around the waterfront talking informally with their colleagues in a manner which would never be possible by an outsider. In this way, they were able to determine the fishermen's true feelings and weigh the comments of particular fishermen in the light of their own knowledge of the individuals concerned. Most industry related activities connected with the effectiveness of the curriculum and its graduates were undertaken by the fishermen members of the faculty, as reported in Chapters IV and V.

In the early years of the program, faculty members were able to assist fishermen with problems or equipment development as a result of the contacts established. These activities were most helpful in demonstrating the competence of individuals in the various subject areas. Such activities have expanded in size and scope during the later years of the project, so that fishermen have come to look upon the program's Wickford facility as being open to them if they need help with a problem, assistance in the construction of new gear, or conversion of vessels for a more efficient fishing operation. These contacts have also been useful in allowing the fishermen to learn more about the training received by students and therefore appreciate what should and should not be expected of graduates.

The acceptance of graduates by industry has been discussed in Chapter V, and may be summarized by remarking that many of the top skippers at Point Judith have graduates aboard their vessels, and one owner/skipper of two of the largest vessels has five former students as crew members.

Perhaps the most important sign of acceptance is the advice being given to young people by Point Judith skippers, who are encouraging their sons to enroll in the program and gain all they can from the courses. During the past year, two local students, who were determined to withdraw from classes during their first semester, were advised by the project director to discuss their positions with skippers (of their own choice) at Point Judith before finally making up their minds to drop out. They returned several days later to report that they had talked with four or five skippers and several crewmen and had been told, in every case, that they should stay with the program and graduate, as they would be eight to ten years ahead of their friends who had not entered the program; both boys continued classes.

### Capability of Graduates

Program graduates have found a wide range of employment opportunities as outlined in Chapter V and Appendix D. Many of those having previous experience in the industry have found themselves prepared to either operate their own small scale vessel and business, to enter the business side of the industry ashore, or return to fishing aboard a vessel with prospects of rapid promotion. These graduates are likely to make some fairly immediate use of the specific knowledge required by skippers which is included in the curriculum.

On the other hand, graduates who have entered the program directly from high school, the military, or from other colleges, and having little or no previous fishing experience, are unlikely to find use for much of the specialized knowledge for several years. Their first job is likely to be working on deck, and the vessel's skipper is unlikely to be impressed with knowledge of navigation, ship stability, or electronics, and would not dream of letting an inexperienced man loose in the engine room. This type of graduate (about half the total) will undertake general deckwork, handling the fishing gear, handling and storing the catch, and repairing the nets and working gear.

Once he has a little practice at the actual fishing operation and arrangement of gear aboard a particular vessel, then this work becomes routine. The principal opportunity for the graduate to illustrate his knowledge and ability is in twine work, net repair and rigging of the fishing gear. It is of vital importance, therefore, that students attain a high level of skill development in these particular areas, as their progress in the industry may well depend on how they perform during the first few months at sea. Special emphasis is placed on assisting students to gain skills in twine work during the program, and they are encouraged to spend much of their spare time in the fishing gear laboratory.

The faculty feels that a minimum of two years of general deckwork is an important experience and preparation for most graduates, although several have been advanced to more responsible positions of engineer or mate within a year after joining a vessel.

### Self Study

In late 1970 and early 1971, the University of Rhode Island embarked on a "Self Study." As part of this program, the Department of Fisheries and Marine Technology

undertook self-evaluation activities, and the opportunity was taken to conduct a study into the effectiveness of the two-year associate degree program developed under this project. The report was prepared in May 1971, at a time when the second curriculum revision had been completed but was not yet effective.

Activities for the departmental self study included a series of department meetings including both faculty and staff people, informal discussions between students, faculty, and staff, and an open hearing attended by faculty, students, and an industry representative. Input from the Student Marine Fisheries Association was also received. The following paragraphs summarize the principal findings of the study as they affected this project.

Curriculum revisions had increased the professional content and application background while removing extraneous matter considered relatively unimportant. Philosophically, while ascribing to the view that general education is an important facet of university life and valuable to all men, time is short in any two-year program. If students are to be recognized as competent when entering the job market, this must be foremost in the mind of everyone concerned with the program. This latter statement was considered particularly appropriate as regards the fishing industry, where job competence is paramount, and graduates who are not able to demonstrate the level desired will reflect upon the usefulness of education and training programs for the industry.

The close contact developed between students and faculty was considered important to the continuing progress of the program, and was found an extremely useful and informative process that could prove gratifying and embarrassing to both faculty and students.

As might be expected, there were differing opinions on the applicability of particular courses to the overall aims of the curriculum, and students each year had been forthright in making their views known. As all students followed the same curriculum they were able to voice their conclusions, particularly through the Student Marine Fisheries Association, and were able to provide a very real source of ideas for discussion. Students had tended to concentrate their opinions along definite lines in particular years, so that any immediate response was likely to lead to requests for its reversal the following year.

Students were in general agreement on the desirability of providing some options in the curriculum, perhaps in the form of elective courses to provide increased emphasis in particular areas. Other participants felt that such action would tend to fragment the curriculum and reduce its effectiveness. All those involved considered that the curriculum, as finally revised, represented an all-round balance between appropriate subject areas. It is interesting to note that the one free elective course, included in the curriculum effective in September 1971, has not generally been used by students to increase their knowledge in a particular area of use in commercial fisheries.

The work load placed on faculty involved in the program was, in many cases, at least double the University average. This was felt to be necessary in order to achieve quality instruction in a program of this nature, but the load could be eased considerably by the provision of further technician and secretarial help (Chap. III).

It was felt necessary to restrict the number of students entering each year to between thirty-six and forty until further teaching positions were available and some provision made for increased vessel accommodations.

In general, facilities were felt to be adequate; a large number of laboratories were needed because of the wide range of disciplines inherent in an applied marine program. Unused time was available in several laboratories that were only used during one semester each year. It was felt that a wider range of applied marine technology programs associated with the same facility could provide for more full use of laboratories.

The factor mentioned most often by all groups participating in the self study was the need for a larger training vessel. The 47-foot "Gail Ann" had proved entirely successful as a teaching facility but was limited in the number of students it was possible to have aboard in one section, and by the feasible operating area during the academic year. It was felt that both these problems could be eased by the use of a larger vessel. Considerable time had been committed to evaluation of various vessel types and sizes so that basic requirements had been established. An outline description of the vessel considered suitable has been included in Chapter VII.

## The United States Coast Guard

The Coast Guard had expressed interest in this project since its inception, and in 1967, the Officer in Charge, Marine Inspection, Providence, R.I., had been designated as Coast Guard representative on the program's Advisory Council (Appendix A).

In many foreign countries, including Canada and the United Kingdom, time spent by students training in colleges is creditable towards license qualifications, normally as a reduction in the sea time needed by an applicant before being permitted to take the appropriate license examination. In early 1969, the question of whether a similar possibility existed in connection with Coast Guard licenses was raised with the Marine Inspection Officer in Providence. This officer discussed the program with personnel at Coast Guard Headquarters, who indicated an interest in evaluating the curriculum and training for possible approval.

A complete description of the program, its purpose, expected benefits and probable future plans, including details of the curriculum, courses and aboard vessel training, was sent to the Commandant in December 1969, with a request that the program be considered for qualifying graduates as eligible to be examined for an appropriate license.

Following some clarifying correspondence, the Chief of the Merchant Marine Safety Division of the First Coast Guard District in Boston visited the program to inspect the personnel, facilities and equipment used in student training.

As a result of this evaluation, the Coast Guard found that the program was oriented toward developing a graduate who would qualify for a deck or engineer officer's license on uninspected commercial fishing vessels. In order to qualify for a license as mate or engineer, a candidate was normally expected to serve three years at sea. It was recognized, however, that a course of instruction specializing in some phase of sea going was comparable to experience which could be gained at sea; however, one year of sea service had been established as the minimum requirement to ensure an applicant for a license had sufficient practical experience. As graduates would gain a total of three-months' sea time during the two years of the program, it was proposed that they would be considered qualified to take the appropriate license examination following an additional nine months' experience at sea.



This proposal meant that graduates were credited with 27 months' sea time, and need only complete one-quarter of the total normally required for eligibility to take the license examination. Many students entering the program would already have sufficient sea time and, if they wished, would be able to take the examination immediately upon graduation.

A letter confirming this approval was received from the Chief, Merchant Vessel Personnel Division, Coast Guard Headquarters, on July 28, 1970.

In June 1971, the sea time requirement in order for graduates to take examinations for original licenses authorizing service aboard uninspected fishing vessels was further reduced to a total of six months or one-sixth of that required of non-graduates.

#### New England Resource Center for Occupational Education

In early June 1972 on termination of this project, the Director asked the New England Resource Center for Occupational Education (NERCOE) to survey the program as it had developed in terms of initial expectations.

The Associate Director of NERCOE, who undertook the survey, had been Associate Commissioner of Vocational Education, State of Rhode Island, at the time the project was established, and had remained a member of the Advisory council; his associate during the survey was the Coordinator of Evaluation Services for NERCOE.

The team visited the program's facilities at Wickford, and inspected the laboratories and training vessel. They met with the Project Director and faculty to gain an understanding of the way in which development had been pursued, and to obtain basic evaluative data. This was followed by meeting with a group of people who had been involved with the program and watched its progress from inception. This group included:

- The originator of the project (Dr. A. Holmsen).
- The owner/skipper of two Point Judith fishing vessels, and employer of five graduates.
- The Program Director for Vessels and Engineering, National Marine Fisheries Service, Woods Hole, Mass.
- The proprietor of a Marine Electronics Company.
- The Coordinator of the Sea Grant College Program at the University of Rhode Island.

A survey report prepared by the NERCOE team is included in Appendix N. This group found the facilities and curriculum to be almost totally adapted to the interests and needs of fisheries students and felt that the early and deep involvement of local industry people had been one of the major reasons behind this success.

A particular note was made of the good reputation being established by graduates in the industry.

#### National Sea Grant Program

The associate degree curriculum in commercial fisheries, developed during this project, forms part of the total commitment of the University of Rhode Island in the area of marine science and technology, and has special importance in connection with the University's Sea Grant Program activities. As such, presentations have been made to Sea Grant site-visit teams each year beginning in 1968. No formal report on these evaluation activities is made available, however during the work of the NERCOE team (reported in the previous section), the Coordinator of Sea Grant Programs at the University stated that the curriculum had received "high marks" during each of the years it had been examined by Sea Grant teams.

On September 7, 1971, the University of Rhode Island was one of the first four United States institutions to receive designation as a Sea Grant College. In the news release accompanying this announcement, the Secretary of Commerce noted that one of the principal reasons behind the University receiving this designation was that it has conducted one of the Nation's best commercial fishery technician programs.

## CHAPTER IX

### CONCLUDING REMARKS AND RECOMMENDATIONS

#### Industry Support

Interest of the commercial fishing industry, especially as represented by the Point Judith Fishermen's Cooperative, was a vital factor leading to the establishment of the project and has been continued and expanded through providing employment opportunities for graduates.

The various industries supplying equipment and supporting services to the commercial fishing fleets have proved equally interested in assisting development of the program, many companies providing active and valuable support by donating equipment and teaching aids, or by making scholarship aid available for students.

Equipment Donations. Many expensive items of equipment and teaching aids have been donated, made available at nominal cost, or provided on a permanent loan arrangement. A complete list of companies who have assisted in this way is included in Appendix O.

Large items of equipment obtained in these ways have included:

- A cut-away marine diesel engine with electric drive.
- Three working marine diesel engines.
- A marine reduction/reverse gear.
- Cut-away pumps, valves and other hydraulic equipment.
- A loran simulator.
- A Decca Navigator simulator with additional receiver.
- A basic sonar.
- Two radar sets.
- Wall displays of twine and cordage.
- Dummy lifesaving equipment used as a teaching aid.
- Films and slide collections.
- Fishing vessel plans and specifications.
- Training aids used in companies' in-house courses.

The willingness of industry to make these donations has enabled a much more comprehensive range of modern equipment to be presented for student use than would have been possible had it been necessary to purchase the items at regular prices. From the viewpoint of industry, the donations have provided students with the opportunity to become familiar with a particular company's products during training, so that it would be quite likely for graduates to specify a similar make when purchasing

equipment later.

Scholarships. Scholarship aid has been available to students through the regular University Student Aid Office system of grants and loans; also by scholarships especially provided for fisheries program students by national and local companies and institutions.

Scholarships were offered by Kelvin Hughes Division of Smiths Industries, Inc., and the National Fisheries Institute, Inc. Other scholarship aid available for division among students has been provided by the Ashaway Line and Twine Manufacturing Company, the Eppley Foundation for Research, Inc., and the Woman's Seamen's Friends Society of Connecticut.

Donors of the two principal scholarships stipulated that award decisions should be made by the program faculty; criteria were established for this purpose, awards being made each year to second-year students on the basis of financial need, ability, and potential for success in the commercial fishing industry. In addition to assisting needy students to complete their education, the awards represented a recognition of achievement and potential both within the program and the industry.

The other scholarship aid applying specifically to students in the program was allocated through joint action of faculty and the University's Student Aid Office. The basis used was financial need, with preference given to second-year students. The involvement of faculty in these decisions was found highly desirable in order to ensure that aid was received by those students who needed it most, and who were likely to prove successful in the program.

#### Development of Associated Programs

The establishment of the two-year commercial fisheries program at the University of Rhode Island provided a resource of expertise and facilities that has resulted in the development of a wide range of educational, research, and public service activities. Most of these activities would not have been viable without the presence of the experienced marine industry people associated with this program. Educational developments have been possible by building upon the courses developed for the associate degree curriculum.

Developments at the University that can be attributed directly to the presence of this project include:

Evening Courses. Through the University's Extension Division, courses from the two-year curriculum have been offered to the public during evenings. Navigation I, providing instruction in coastal navigation, has proved extremely popular among yachtsmen, and has been over-subscribed each year since 1968. Navigation II, covering celestial navigation, was taught in 1971 for the first time, and will be available every second year. Plans are under way to offer Seamanship as an evening course in the coming academic year, and to develop a new course in gasoline marine engines at the request of the local pleasure-craft industry.

Summer Courses. The Seamanship and Fishing Gear I courses are being taught during the University's Summer Session for the first time in 1972. If successful, a wider range of offerings will be provided in future years.

Four-Year Program in Marine Resources. An undergraduate option in Marine Resources has been developed with the University's Curriculum in Natural Resources. The major concentration of this option is built upon fisheries, together with several new courses established within the Department of Fisheries and Marine Technology. The program is designed so that students can gain applied marine skills from the fisheries program courses, together with an applied science and general education background. It is a natural next step for graduates of the commercial fisheries program who wish to continue their education, and provides an opportunity for them to gain an introduction to a number of marine areas, including oceanography, ocean engineering, and education.

Vocational Teacher Education. Cooperative arrangements are being established with the Department of Industrial Education at Rhode Island College, permitting graduates of the two-year fisheries program to complete a bachelor's degree in vocational education. Similarly, educational students at that college wishing to specialize in marine technology may use courses developed for the fisheries curriculum. It is hoped that these arrangements will be a first step towards meeting an expected need for instructors in the applied marine field.

Sea Grant Program. As reported in the previous chapter, the curriculum developed during this project has formed a vital part of the University's Sea Grant Program. In addition, the faculty and facilities have been used during other projects in the program, particularly those outlined under the next two headings.

Fishing Gear Research and Development. Cooperative activities are undertaken by various program faculty with the University's Department of Ocean Engineering in applied research on the behavior and development of various types of fishing gear. This is a Sea Grant project and provides an important support activity to the extension work.

Extension Work with the Fishing Industry. Program faculty have been involved in extension work with Rhode Island and New England fishing fleets since 1967. Not only have these activities proved a valuable vehicle for promoting individual competence, but they have also resulted in solid developments that have improved the economy of the fishermen. Supported first under the State Technical Services Act of 1965, the activities have now been developed into a broad-based Marine Advisory Service as part of the Sea Grant commitment of the University. Program faculty continue to provide specialist assistance, and a full-time commercial fisheries extension specialist is based in the Department of Fisheries and Marine Technology; this man also teaches the Marine Technology course in the fisheries curriculum, so that excellent cooperative arrangements exist.

International Activities. Faculty members have provided needed expertise in practical fishing aspects of commercial fisheries development, and the establishment of fisheries education facilities in developing countries, especially in connection with the University's International Center for Marine Resource Development.

#### Opportunities for Graduates

The primary purpose of the program was to prepare young men for the fishing industry, and over half the graduates have, in fact, entered the fishing fleets (Chap. V). It was recognized from the program's inception, however, that the curriculum would also be useful to students wishing to enter other areas of marine and fisheries activities. Several graduates have been interested in making their career in an associated field and a number of such possibilities have become apparent.

Graduates have been, or are presently, employed in the following areas:

At sea with the commercial fishing industry.

At sea with the sports or charter fishing industry.

At sea as fisheries technician aboard a research vessel.

As executive secretary of a fishermen's association.

In administrative or managerial positions with fishing companies or fish plants.

With state agencies as fisheries or wildlife wardens or officers.

With the insurance industry.

As fisheries development officer with a state agency.

Further employment possibilities that have become apparent through individual contact between faculty members and the industry, student activities, or direct requests from companies are:

At sea aboard service vessels for the oil industry.

At sea aboard tugs.

At sea aboard support ships for underwater craft or facilities.

At sea aboard port service vessels such as dredges or barge systems.

At sea as professional yacht skippers.

At sea in the more general field of merchant vessel service.

At sea aboard support vessels for research establishments, power stations, marine authorities, etc.

As technicians in government establishments.

As technical representatives or technicians for gear and equipment manufacturers: engines, electronics, fishing gear, engineering services, shipyards, cordage, fishing supplies, safety equipment.

In net lofts.

In marina operations.

In vessel brokerage and surveying.

It is interesting to note that a number of students have worked in several of these areas for their industrial

experience between the academic years, or while attending the University, in order to assist in financing their training. Local fishing gear companies have employed several students each year to cut out and make up nets, and this has proved a most satisfactory arrangement for both the students and the companies.

A number of students have considered entering government service with the National Marine Fisheries Service, but career possibilities at the technician level appear to be limited in grade level, and therefore salary, attainable for men who do not possess a bachelor's degree.

Other graduates have been interested in international fisheries development work, and opportunities exist with such organizations as the Peace Corps, whose representatives visit the program regularly on recruiting trips. No graduates have yet worked with the Peace Corps or a similar voluntary organization, primarily because that type of experience appeared unlikely to qualify them for a career possibility. Contact has been established with the Food and Agriculture Organization of the United Nations, which employs a large number of fisheries experts with varying backgrounds; however, their requirement is for a person with a bachelor's degree, or a "master fisherman" who is expected to have considerable experience in commercial fishing.

One graduate who already possessed a bachelor's degree before entering the program has since returned to his native Puerto Rico to work on fisheries development with the government.

Definite possibilities do appear to exist for graduates who wish to work in these areas and who are able to continue their education to the bachelor's level or above. This has prompted several of the program's former students to work towards this qualification.

One graduate from the first entry transferred to the College of Fisheries at the University of Washington, completed his bachelor's degree there, and has now returned to work on an aquaculture development program at this University.

In 1970, with the establishment of an undergraduate curriculum in Natural Resources at the University of Rhode Island, it was no longer necessary for students to transfer to other universities. Graduates of the two-year commercial fisheries program were permitted to transfer into the Natural Resources Curriculum, and one



graduate in 1970 did so. With previous college credits, he was able to complete his bachelor's degree in 1971 and continued in the Master of Marine Affairs Program at this University, earning a master's degree in 1972. He is now the Executive Secretary of the Atlantic Offshore Fish and Lobster Association.

The establishment of the Marine Resources option within the Natural Resources Curriculum is expected to offer a further and more appropriate opportunity for fisheries program students, and several of this year's graduates have elected to transfer into the option.

Several graduates from previous classes and one from this year's graduating class have been interested in working towards teaching positions in programs similar to that developed under this project. Contacts that have been established indicate this represents a real possibility at the Junior or Community College level, as a number of marine technician programs are under development. The recent agreement with Rhode Island College permitting graduates to work for a degree in vocational education, is expected to provide a more effective opportunity for people wishing to work in this field.

#### Future of the Program

The two-year associate degree program in commercial fisheries has been accepted as part of the general teaching program of the University of Rhode Island. It will continue to be administered within the Department of Fisheries and Marine Technology, and is funded under the general teaching budget for that department.

Students in the curriculum will continue to be recognized as a unique group, and not amalgamated into the general undergraduate program of the University. This is considered especially desirable since it will allow the rigorous industry-oriented approach, developed during this project, to continue.

Undergraduate students registered in the new four-year Marine Resources option will be assigned to advisors within the Department of Fisheries and Marine Technology and will use many of the same courses as the fisheries program students. However, it is anticipated that the use of separate laboratory sections for these men will prove effective in maintaining the tight-knit atmosphere of the fisheries program, while also providing a more effective use of laboratory space. Expectations are that students from both curriculums will gain a worthwhile experience as a result of both formal and informal contact.

Support for the new program is being provided through the University's Sea Grant Program, and includes a provision for additional staffing. The four-year program is being looked upon as a complementary activity rather than a direct continuation or alternative to the two-year curriculum.

#### Value as a Regional Program

This program, although established primarily with the support of the Rhode Island fishing industry, has been operated as a regional program from its inception. Students have entered from all the New England states and have formed a substantial portion of the entering classes as outlined in Chapter V.

In addition to forming a rather distinct geographical region, New England offers a fishing industry that is regional in terms of its activities and fishing grounds. The New England Board of Higher Education is responsible for coordinating programs available at higher education institutions within the six state region, in order to make best use of available facilities and provide a wide range of educational programs. Under these arrangements qualified students from all the New England states attend the two-year fisheries curriculum under the same conditions as Rhode Island residents; that is, without payment of the usual non-resident tuition fee. Similarly, Rhode Islanders wishing to enter a curriculum which is not available within the state (such as forestry) can attend a university within the region that offers a suitable program on the same terms. This arrangement provides students from all states with a broad choice of educational opportunities without the need for every state to provide curriculums (which may be under-subscribed) in all the areas.

On starting development of the two-year fisheries curriculum, it had been intended to enter forty students each year, but this number has not yet been reached, although students are recruited from the six-state region. The number of applicants for entry to the program has shown an increase during the last two years, and if this trend continues, an entering freshman class of forty should be reached in 1972 or 1973. This is felt to be the maximum number of students it is possible to enter each year with the present staff, although a number of the laboratories are presently under-utilized.

As student numbers are restricted more by requirements for faculty and training vessel time than by physical space, it might be expected that a larger

entering class could be accepted if needs in these areas are met. The cost of providing the range of laboratories needed for this curriculum is high (as outlined in the concluding section of this chapter). Should the demand for student places continue to grow, it is considered preferable to expand the capabilities of the present program and maintain its regional status, rather than establish any new programs, until the present facilities are fully utilized.

#### Need for Additional Programs in the United States

Any plans to introduce a similar curriculum in another area of the country should give particular attention to the question of student numbers which may be anticipated. Based on experience in developing this program, it would appear that the most appropriate application of future programs would be for their use on a regional basis in order to avoid direct competition among nearby institutions for students from the same areas.

Support for this approach is strengthened when account is taken of the relatively high cost of establishing programs (this is discussed further in the following section), and the apparent dearth of persons having the qualifications and experience found desirable for faculty positions. It is recommended, therefore, that programs be introduced on a regional basis, at first, with additional units provided only when necessary to meet a demand for enrollment that is matched by the ability of industry to employ graduates.

In the same way that New England presents a natural fishing region, other areas of the United States tend to divide into particular fishing regions, such as Alaska, the Pacific Northwest, the Pacific Coast, the Gulf of Mexico and adjacent areas, the Atlantic Coast, and the Great Lakes. In each of these areas, the commercial fishing industry is operated in a particular manner suited to local conditions, the types of fishing undertaken, and the fishing grounds used. The establishment of commercial fisheries curriculums in each of these regions would therefore appear to represent an effective first step in providing better trained and educated young men, who will, at some time in the future, command the more sophisticated fishing vessels being developed as a result of the application of modern technology.

Throughout the development of this program, requests for information concerning progress and the curriculum have come from many people in industry and colleges throughout the Nation. In addition, visitors who are

involved in both the fishing industry or education have been welcomed from such widely separated parts of the country as Florida, Alaska, Oregon, and Texas. Interest has strengthened following development of Sea Grant programs throughout the coastal and Great Lakes regions. Programs gathered under a general title of "Marine Technician" have been developed by a number of two-year colleges in association with local Sea Grant program activities.

According to information available in the press and from personal contact established with the people involved, only a few of these programs have application to commercial fishing, and in such cases emphasis is usually placed on training for other marine employment in addition to the commercial fisheries content. Based on experience gained during the present program, this is not recommended.

The particular requirements of the commercial fishing industry (as outlined in various chapters of this report) ensure that graduates of a program and curriculum designed for that industry have the necessary preparation for sea-going and shoreside work in associated industries. It is felt that graduates of a more general marine program are unlikely to have acquired the specific skills and qualities needed to ensure success with the commercial fishing industry. Therefore, the program should concentrate on the commercial fisheries aspect of training rather than making that only a part of a more general all-round marine curriculum.

The following section has been prepared to offer guidance in establishing programs preparing students for the commercial fishing industry.

#### Establishing a Program

Based on experience accrued during the development and five years' operation of this project, these recommendations and comments have been prepared in the hope that they will prove of assistance to readers who are, or may become, involved in the establishment of similar programs.

It is realized that individual programs must be arranged to suit the conditions existing in a particular area, so that every attempt has been made to arrange the remarks in a general fashion.

Industry Support and Involvement. The support of an area's fishing industry is considered essential, and

representatives of all local industry groups should be involved in preliminary planning. It is considered unlikely that fishermen will be willing to commit themselves to hiring graduates at this stage (preferring to judge them on their merits as they become available) but their general support of the concept is necessary. The active involvement of acknowledged top fishermen from the local area as faculty members teaching in the program will provide the required direct contact and two-way communication. The employment of an experienced skipper, who is thoroughly familiar with the local fishing grounds, is essential for a Fishing Operations course. A good indication of the acceptance of a program and its faculty is when local fishermen begin to visit the facilities and take advantage of the available equipment and expertise.

Waterfront Location. Location at a waterfront is required. If a site is available in an industrial setting, this should prove beneficial, but it is not considered essential. At this site, buildings should be available at which all the second-year work can be undertaken, with an adjacent sheltered berth suitable for the training vessel. If the sponsoring institution is on the waterfront, then this represents an ideal situation, as all classes can be undertaken at one location. Alternatively, a split-campus arrangement must be accepted to ensure that all applied activities take place in the waterfront setting, and permit the necessary close working relationship between professional faculty and students to be realized.

Project Director. This man need not be drawn from a local industrial or educational situation. In many cases it will be found that a person selected from outside the area will be able to provide a more effective overview of the local situation and not be subject to established local views. He should, however, have accepted academic qualifications, industrial experience in some area of the commercial fisheries, and preferably have participated in a commercial fisheries training program elsewhere.

Staff. It is essential that all the instructors involved in the program are well qualified in their area of expertise and have at least several years' experience in the application of their subject area to commercial fishing. Guidance concerning sources from which faculty may be recruited for various positions is included in Chapter III. Experienced fishing skippers have an important place on the faculty; they are often available through being forced to "come ashore" as a result of poor health or injury, but otherwise will be difficult

to attract due to the excellent living normally enjoyed by successful fishermen. It is important that only fishermen acknowledged by their colleagues as competent and successful are associated with the program. Other faculty who are not known locally must expect to have to prove competence in their subject areas in order to gain acceptance by the local fishing community.

Provision of adequate technician help is necessary, especially during the initial stages of setting up facilities. As instructors, in many cases, will be involved in the preparation of their own teaching materials, or the adaptation of existing texts to suit local conditions, adequate secretarial assistance is essential.

Enrollment. During early years of the program, when laboratories and facilities are being developed, it will be found advantageous to restrict the number of students enrolled. This also is desirable from the viewpoint of placing graduates from the first classes, as difficulties may be expected if more graduates are produced in the early years than can be absorbed by industry. As graduates prove themselves to industry so that larger numbers can be absorbed, and the facilities are developed fully, the number of students enrolled each year can be gradually increased. An entering class of between thirty and forty students has proved a convenient size. Essentially the same laboratory and support facilities are required for this number as for an entering class of fifty or sixty. There seems to be no real reason, therefore, why a larger enrollment is not possible, providing the industry can absorb the number of graduates emerging, and sufficient staff and training vessel time is available.

Standard of Graduates. It is essential that all graduates demonstrate a level of skill competence and an appropriate attitude, permitting them to be accepted readily by the industry. It should not be expected that all graduates will exhibit "skipper potential," but the success of the program is likely to depend on fishermen being able to count on graduates to provide an adequate level of work ability.

Students. It is considered desirable to undertake some form of screening applicants for admission. Aptitude test scores appear to provide a guide to potential for graduation (Chap. V). Previous experience or connection with the fishing industry may well not lead to graduation unless accompanied by some demonstration of preparatory achievement. Although sons of fishermen may not be able to handle all aspects of course work satisfactorily, they should be allowed to complete as many

courses as possible, in order to provide them with a better preparation for their chosen work, and to promote good industry/program relations.

Curriculum. While concentrating on preparing students for the conditions met within the commercial fisheries of the area in which the program is situated, the curriculum should include general information on the fisheries of the whole North American Continent and the world. This is necessary in order to prepare them for the increasingly complex international fisheries situations that are developing, to provide them with knowledge of how fishing is carried out in other areas using many different fishing methods and types of gear which may at some time be introduced locally, and to make them aware of career possibilities outside their own area. This last point is important as it has been found that many students are interested in gaining a wide experience of different fisheries, or in making their careers in other areas.

Applied aspects of the courses should make full use of local conditions, so that the emphasis of various courses in the curriculum outlined in Chapter IV, especially those in fishing gear and fishing operations, should be adjusted to reflect the fishing methods and gear applicable to the local area.

Great emphasis is desirable on gaining a high level of skill proficiency in the various practical aspects of course work, especially in the areas of fishing gear, seamanship, and aboard vessel work.

Physical Facilities. Chapter VI provides a guide to the laboratories and other areas needed. If the program is established at an institution that already operates curriculums in an associated area, then existing facilities may be utilized for some of the courses. Typically, this may be found convenient for engineering technology or the electrical work, although care must be taken to ensure that students primarily use equipment suited for marine and fisheries duty for the applied aspects of their training. Laboratories and work areas should be outfitted in an applied fisheries manner with simple rugged systems, permitting students to work in the same manner as used in the industry and allowing maximum student participation in the rigging, manipulation and unrigging of demonstration and instructional apparatus.

Equipment. All equipment used during the program should be representative of modern commercial units used

in the fishing industry, and include a wide range of types and makes. The use of outdated, ex-service, or non-commercial equipment should be discouraged unless the particular items are in regular use by the local industry. Many expensive items of equipment, including engines and electronic navigation and fish detection devices, can be obtained from manufacturers as donations, on permanent loan, or at token cost, and every effort should be made to take advantage of such opportunities.

Simulators for individual use by students to gain experience in the operation and use of equipment (particularly electronic aids) will prove especially useful, as will mock-ups of typical aboard-vessel arrangements of various rigging and systems.

Training Vessel. Guidance concerning the choice of a suitable training vessel is included in Chapter VII. Considerable care is necessary in choosing a vessel, and it is particularly important to restrain enthusiasm for obtaining any large or elderly craft which may be offered for very little money. Such ships are very often not suited for use in a fisheries program, and are likely to be constantly in need of expensive and time consuming maintenance and repairs. If an ex-service vessel which is of a size requiring compliance with Coast Guard regulations other than those for uninspected vessels is acquired, then considerable expense is likely to be involved; first, in converting it for use, and then in maintaining it's condition.

In all cases, the nearest Marine Inspection Office of the Coast Guard will be found most helpful, and liaison should be maintained with the Officer in Charge throughout the program.

Costs. It is extremely difficult to provide any estimate regarding the total cost of establishing a program, due to the very different circumstances likely to exist in each particular situation.

The list below indicates the approximate costs of purchasing equipment needed in order to outfit the various laboratories for the program developed during this project. The figures do not include the estimated value of donated equipment (in the order of \$22,000), or the cost of labor and materials for construction work which was undertaken by the program faculty and staff:

Seamanship Laboratory. . . . .	\$ 3,000
Navigation Laboratory. . . . .	3,200



Electrical Laboratory. . . . .	\$ 3,500
Electronic Aids Laboratory . . . . .	19,000
Meteorology Laboratory . . . . .	1,000
Engineering Laboratory . . . . .	28,000
Fishing Gear Laboratory. . . . .	7,500
Furniture and Fittings . . . . .	6,000
Miscellaneous (visual aid equipment books, etc.). . . . .	5,000

The training vessel was obtained at no cost; the total expense of structural modifications was in the order of \$16,000 and the estimated value of equipment purchased and installed aboard in order to outfit the vessel for training purposes was \$37,000.

So far as operating costs are concerned, these will again depend on the individual situation, especially with respect to physical facilities. A reasonably exact estimate of the average annual operating expense for the program as developed is included in Table 12. It might be expected that these estimates would provide a guide to the costs which might be incurred by a similar program, especially under the "teaching supplies" heading.

TABLE 12 - ESTIMATED ANNUAL OPERATING COSTS FOR  
TWO-YEAR COMMERCIAL FISHERIES PROGRAM\*

<u>Buildings</u>	<u>Annual Cost</u>
Building rental	\$15,000
Utilities (heat, electricity, water)	2,500
Janitorial services, linen, garbage collection	2,200
	<u>19,700</u>
<u>Support Services</u>	
Equipment maintenance and repairs	1,200
Postage, telephone, office supplies	1,200
Travel (Fish Expo, local, and to high schools)	1,500
Library	300
	<u>4,200</u>
<u>Personnel</u>	
4-1/2 Faculty (equivalent) @ \$15,000 p.a.	67,500
Technician	9,000
Secretarial	6,000
15% staff benefits	12,400
	<u>94,900</u>
<u>Teaching Supplies</u>	
Fishing Gear Lab	4,500
Electrical and Electronics Lab	300
Navigation Lab	400
Seamanship Lab	1,000
Engineering Lab	2,200
General	800
	<u>9,200</u>
<u>Vessel Operation</u>	
Operation of "Gail Ann"	6,600
20 days charter of "La Nina"***	3,000
	<u>9,600</u>
 TOTAL	 <u>\$137,600</u>

\*It is assumed that 40 first-year and 25 second-year students are enrolled.

\*\*No additional costs are involved with "La Nina" as operation is self-supporting.

## APPENDIX A

### Membership of the Advisory Council

James W. Cobble - Dean of the College of Resource Development, Director of the Agricultural Experiment Station and Director of the Cooperative Extension Service, University of Rhode Island (Chairman).

James Ackert - President, Atlantic Fishermen's Union, Boston, Mass.

Jacob J. Dykstra - President, Point Judith Fishermen's Cooperative Association, Rhode Island.

Andreas A. Holmsen - Professor of Food and Resource Economics, University of Rhode Island.

John A. Knauss - Provost for Marine Affairs, Dean of the Graduate School of Oceanography, University of Rhode Island.

James A. McCauley - Point Judith Fishermen's Cooperative Association, Assistant Professor of Fisheries and Marine Technology, University of Rhode Island.

Saul B. Saila - Professor of Oceanography, University of Rhode Island.

Thomas A. Sandham - Associate Director, New England Resource Center for Occupational Education. (Formerly Associate Commissioner for Vocational Education, State of Rhode Island.)

Joseph M. Slavin - National Marine Fisheries Service, Washington, D.C.

Commander E.A. Schmidt - United States Coast Guard, Providence (1967-1969).

Commander Folger - United States Coast Guard, Providence (1969-1972).

Keith A. Smith - Program Director, Vessels and Engineering, Northeast Fisheries Center, National Marine Fisheries Service, Woods Hole, Mass.

Several meetings of the Advisory Council took place in late 1966 and early 1967 to determine procedures for establishing the program, and to approve the appointment of the Project Director.

A further formal meeting was held in May 1968 to review the first year of program operations and examine the facilities established.

No additional formal meetings took place. The Project Director has maintained contact with the membership on an individual basis to discuss progress and seek advice. All members have visited the facilities and met with faculty on a number of occasions throughout the program development.

APPENDIX B  
CURRICULAR VITAE FOR FISHERIES FACULTY

List of Professional Fisheries Personnel Based in the  
Department of Fisheries and Marine Technology

<u>NAME</u>	<u>POSITION</u>	<u>APPOINTED</u>	<u>RESIGNED</u>	<u>FIELD</u>
John C. Sainsbury	Project Director Assoc. Prof.	Feb. 1967	-	General fisheries Vessel technology Vessel operations
David Mead	Counselor/Evaluator	May 1967	June 1969	Student counseling and evaluation
Gladys Coggeshall	Secretary	May 1967	-	Administrative assistance, Typing
Geoffrey A. Motte	Assist. Prof. Equiv.	June 1967	-	Navigation, Sea- manship, Meteor- ology, Vessel operations
David B. Thomson	Assist. Prof. Equiv.	June 1967	June 1969	Fishing gear Fishing operations
James A. McCauley	Assist. Prof. Equiv.	Jan. 1968	-	Marine engineering technology, Fish- ing gear, Fishing operations
Joseph Karwiec	Technician/Special Assist.	April 1968	died Feb. 1970	General technician Training vessel skipper
Thomas L. Meade	Assoc. Prof. (1/4 time)	Feb. 1968	-	Fish technology Fisheries biology General fisheries

146/147

<u>NAME</u>	<u>POSITION</u>	<u>APPOINTED</u>	<u>RESIGNED</u>	<u>FIELD</u>
Robert W. Merriam	Assist. Prof. (1/4 time)	Sept. 1968*	-	Marine electronics Electrical engineering
Albert L. Hillier	Assist. Prof. Equiv.	July 1969	-	Fishing gear Vessel operations Fishing operations
Richard A. Wing	Technician/Special Assist.	July 1970	-	Technician duties Marine engineering technology
Robert E. Taber	Commercial Fisheries Extension Specialist (1/4 time)	July 1970	-	Marine technology
Thomas M. Stout	Instructor Equiv.	Feb. 1971	-	Seamanship vessel operations

\*Robert Merriam provided teaching services under contract during 1968 & 1969, being appointed as a part-time faculty member in July 1970.

NAME: John C. Sainsbury

BIRTH: December 27, 1933

EDUCATION:

4th Year, H.M. Dockyard Technical College, Devonport, England, 1954.

B.Sc. (Hon.), Naval Architecture, University of Durham, England, 1957.

Ph.D., Engineering, University of Southampton, England, 1966.

EMPLOYMENT:

1950-55 Shipwright Apprentice, H.M. Dockyard, Devonport, England.

1957-59 Systems Engineer, Blackburn Aircraft Ltd., Yorkshire, England.

1959-62 Research Assistant, University of Southampton, England.

1962-64 Lecturer-in-Charge, Naval Architecture and Shipbuilding Dept., West Park College, Sunderland, England.

1964-67 Senior Lecturer, Naval Architecture and Shipbuilding Dept., College of Fisheries, St. Johns, Newfoundland.

1967- Chairman, Associate Professor, Fisheries and Marine Technology Dept., University of Rhode Island.

PROFESSIONAL SOCIETIES AND ACTIVITIES: Member Royal Institution of Naval Architects; Chartered Engineer (UK); Professional Engineer (Canada).

PUBLICATIONS: Total number - 60.

Sainsbury, J.C. 1966. What the Fishing Captain Needs to Know to Keep his Ship Stable and Safe. Canadian Fisherman, May, June, July, Aug. Sept.

Sainsbury, J.C. 1968. Operations and Requirements of Fishery Training Vessels. 2nd F.A.O Research Craft Conference, Seattle.

Sainsbury, J.C. 1968. Crew Problems in New England Fishing Fleets - A Place for Education. Proceedings, Gulf and Caribbean Fisheries Inst., 21st Annual Session.

Sainsbury, J.C. 1969. Education for Commercial Fisheries. Encyclopedia of Marine Resources, Van Nostrand Reinhold Co.

Sainsbury, J.C. 1969. The Ocean Fishing Technician. Career Opportunities for Technicians and Specialists - Agricultural, Forestry and Oceanographic Technicians, J.G. Ferguson Publishing Co.

Sainsbury, J.C. 1971. Commercial Fishing Methods. A book published by Fishing News (Books) Ltd., London.

NAME: Thomas L. Meade

BIRTH: July 4, 1920

EDUCATION:

B.S., University of Florida, 1950.

M.S., University of Florida, 1951.

Ph.D., University of Florida, 1953.

EMPLOYMENT:

1939-47 U.S. Army (Ret. Col. USAR).

1947-53 Student, University of Florida (1952-53 Oak Ridge Institute of Nuclear Science Fellow).

1954-55 Animal Nutritionist, Charles Pfizer Co., Indiana.

1955-63 Director of Research, N.J. Menhaden Products, Inc., Wildwood, N.J.

1963-68 Director of Research, J. Howard Smith Inc., Port Monmouth, N.J.

1968- Associate Professor, Fisheries and Marine Technology, University of Rhode Island.

PREFESSIONAL SOCIETIES AND ACTIVITIES: Phi Eta Sigma; Phi Sigma Biological Society; Phi Kappa Phi; Sigma Xi; American Society for Animal Production; American Oil Chemists Society.

PUBLICATIONS: Total number - 18.

Meade, T.L. 1968. Processing Needs of the Fishery By-products Industry. Proc. Conference on Future of the U.S. Fishing Industry, University of Washington Publications in Fisheries, New Series, Vol. 4.

Meade, T.L. 1969. Factors Involved in the Storage and Transport of the American Lobster. New England Marine Resources Information Program, Pub. No. 3.

Meade, T.L. 1969. Statement on Fish Protein Concentrate. Presented before a Select Committee on Nutrition and Human Needs of the U.S. Senate, Ninetieth Congress Second Session, Part 13D Nutrition and Private Industry: Food from the Sea 4891-4893.

Meade, T.L. 1970. Handling and Processing Red Crabs. Commercial Fisheries Review, in Press.

Meade, T.L. 1970. General Microbiological Considerations in the Handling of Raw Fishery Products. Proc. Conference on the Sanitary Quality and Microbial Safety of Fishery Products. Puerto Rico, Sept. 9, 1970, in Press.

Meade, T.L. 1971. Recent Advances in the Fishery By-products Industry. CRC Critical Reviews in Food Technology, 2(1): 1-20.



NAME: James A. McCauley  
BIRTH: September 10, 1931  
EDUCATION:

B.S., General Business, University of Rhode Island,  
1954.  
Infantry School, Ft. Benning, Georgia, 1954.

EMPLOYMENT:

1954-56 Infantry Officer, U.S. Army.  
1956-57 Engineer, Electric Boat Division of General  
Dynamics Corp., Groton, Conn.  
1956-60 Crewman, Fishing Industry, Pt. Judith.  
1960- Captain/Owner, Fishing Vessels, Pt. Judith.  
1968- Assistant Professor, Fisheries and Marine  
Technology, University of Rhode Island.

PROFESSIONAL SOCIETIES AND ACTIVITIES: Member Pt. Judith  
Fishermen's Cooperative Association (Sec./Treas.  
1965-67); Member New Bedford Sea Food Producers  
Association; Chairman pro-tem, Atlantic Offshore  
Fish and Lobster Association.

PUBLICATIONS:

McCauley, J.A. & Krawiec, J.J. 1969. Single Boat  
Midwater Trawling for Herring in Rhode  
Island Waters. Fisheries and Marine  
Technology Report, University of Rhode  
Island.  
McCauley, J.A. 1972. The Lobster Fishery Moves  
Offshore. Maritimes, Vol. 16, No. 3.

NAME: Geoffrey A. Motte  
BIRTH: August 26, 1936  
EDUCATION:

Second Mate, Foreign Going (UK), 1958.  
First Mate, Foreign Going (UK), 1960.  
Master, Foreign Going (UK), 1964.  
M.S., Experimental Statistics, University of Rhode  
Island, 1972.

EMPLOYMENT:

1953-57 Midshipman, Port Line Ltd.  
1957-59 Deck Officer, Alfred Holt Ltd.  
1959-62 Deck Officer, John Holt Ltd.  
1963-64 Master, P&A Campbell Ltd.  
1964-67 Lecturer, Department of Nautical Science,  
College of Fisheries, St. Johns, Newfoundland.  
1967- Assistant Professor, Fisheries and Marine  
Technology, University of Rhode Island

PROFESSIONAL SOCIETIES AND ACTIVITIES: Member Institute  
of Navigation; Member Honorable Company of Bristol  
Channel Pilots; Member American Statistical Society;  
Member Royal Meteorological Society.

PUBLICATIONS:

- Motte, G.A. 1969. Selecting a Radar Set for a Fish-  
ing Vessel. University of Rhode Island State  
Technical Services Program.
- Motte, G.A. 1970. Cutting Web Tapers. University  
of Rhode Island Sea Grant Program, Marine  
Leaflet No. 1.
- Motte, G.A. 1972. Chartwork for Fishermen and Boat  
Operators. University of Rhode Island Sea  
Grant Program, Marine Bulletin No. 7.
- Motte, G.A. 1972. Navigation for Fishermen and  
Boat Operators. University of Rhode Island  
Sea Grant Program, Marine Bulletin No. 8.

NAME: Albert J. Hillier  
BIRTH: April 18, 1922  
EDUCATION:

Six years, Royal Navy (Petty Officer).  
Radio Telephone License.

EMPLOYMENT:

1946-50 Deckhand, Fishing Vessels, New Bedford.  
1950-54 Mate, Fishing Vessel, New Bedford.  
1954-65 Owner/Skipper, 72-ft. trawler, New Bedford.  
1965-68 Director of M.D.T.A. Fishermen's Training  
School, New Bedford.  
1969- Assistant Professor, Fisheries and Marine  
Technology, University of Rhode Island.

PROFESSIONAL SOCIETIES AND ACTIVITIES: New Bedford Seafood  
Producers' Association (President for two years).

PUBLICATIONS:

Hillier, A.J. 1972. How to Plan and Cut Nets.  
University of Rhode Island Sea Grant Program,  
Marine Bulletin No. 9.

Hillier, A.J. 1972. An Experimental Net for Ground-  
fish Sampling Operations in the Northwest  
Atlantic. Fisheries and Marine Technology  
Report, for National Marine Fisheries  
Service, Northeast Fisheries Center.

NAME: Robert W. Merriam  
BIRTH: July 18, 1923  
EDUCATION:

S.B., Harvard College, 1949.  
S.M., Harvard Engineering School, 1950.  
1st.Cl. Radio Telephone License with Radar  
Endorsement.

EMPLOYMENT:

1950-53 Instructor, Swarthmore College, Pa.  
1953-54 Engineer, Metals and Controls Corp.  
1953-70 Owner, Merriam Marine Radio, Pt. Judith,  
R.I.  
1968- President and Treasurer, Merriam Instruments,  
Inc.  
1970- Assistant Professor, Fisheries and Marine  
Technology, University of Rhode Island.

PROFESSIONAL SOCIETIES AND ACTIVITIES: Treasurer National  
Marine Electronics Association; Society of Harvard  
Engineers and Scientists; Providence Engineering  
Society; U.S. Coast Guard Auxiliary; U.S. Power  
Squadron; Radio Club of America; Founder and Director  
of New England Wireless Museum, Inc.; Member Insti-  
tute of Electrical and Electronic Engineers.

PUBLICATIONS:

Merriam, R.W. Articles on fisheries electronics and  
related subjects, Fishing Gazette, monthly,  
1967-.

NAME: Robert E. Taber  
BIRTH: October 18, 1940  
EDUCATION:

B.S., University of Rhode Island, 1966.  
M.S., University of Rhode Island, 1968.

EMPLOYMENT:

1957-59 (Summers) Commercial Fisherman.  
1960-64 U.S. Marine Corps.  
1968 Instructor, Department of Mechanical  
Engineering, University of Rhode Island.  
1968-70 Oceanographic Specialist, Marine Experi-  
ment Station, University of Rhode Island.  
1970- Commercial Fisheries Extension Specialist,  
Marine Advisory Service, University of  
Rhode Island.

PROFESSIONAL SOCIETIES AND ACTIVITIES: Member American  
Society of Mechanical Engineers.

PUBLICATIONS:

Taber, R.E. Computing Horsepower used in  
Trawling. University of Rhode Island Sea  
Grant Program, Marine Leaflet No. 2.

Taber, R.E. The Dynamics of European Wing  
Trawls. University of Rhode Island Sea Grant  
Program, Marine Leaflet No. 3.

Taber, R.E. Evaluation of the 71-91 Wilcox  
Trawl. University of Rhode Island Sea Grant  
Program, in Press.

NAME: Thomas M. Stout  
BIRTH: July 7, 1935  
EDUCATION:

B.S., U.S. Merchant Marine Academy, Kings Point,  
1961.  
M.S., Long Island University, 1969.  
Unlimited 3rd Mate's License.

EMPLOYMENT:

1961-63 Active duty as Operations Officer, U.S. Navy  
(Oceanographic and hydrographic Survey  
Activities).  
1963-64 Yacht Master and Assistant Port Steward,  
Skaarup Shipping Corp., New York.  
1964 Cargo Mate, Grace Line, Inc., New York.  
1964-68 Oceanographer, National Oceanographic Data  
Center, Washington, D.C.  
1968 Graduate Assistant, Department of Marine  
Science, Long Island University, New York.  
1968-69 Oceanographer, Offshore/Sea Development  
Corp., New York.  
1969-70 Engineer, Raytheon Co., Portsmouth, Rhode  
Island.  
1970- Instructor, Fisheries and Marine Technology,  
University of Rhode Island.

PROFESSIONAL SOCIETIES AND ACTIVITIES: Member Marine  
Technology Society.

NAME: Richard A. Wing  
BIRTH: January 13, 1944  
EDUCATION:

Graduate of General Motors Diesel Service School.  
Will complete B.S. in Industrial/Vocational  
Education in 1973.

EMPLOYMENT:

1962-66 Various positions as marine engine mechanic  
in Rhode Island industry.  
1966-69 Diesel Mechanic, Pt. Judith Engine and  
Supply Co., Pt. Judith, Rhode Island.  
1969- Technician/Special Assistant in Fisheries  
and Marine Technology, University of Rhode  
Island.

APPENDIX C  
CLASS SCHEDULES

STUDENT SECTION SIZES FOR LABORATORY SESSIONS  
FACULTY CONTACT HOURS REQUIRED FOR COURSES

CLASS SCHEDULE: FIRST SEMESTER

	MONDAY	TUESDAY	WEDNESDAY	THURSDAY	FRIDAY
8:00 a.m.	REN 135 Fisheries Economics		REN 135 Fisheries Economics		REN 135 Fisheries Economics
9:00 a.m.				Sect. 1: FIS 013 (gear lab)	
10:00 a.m.	FIS 118 Intro. to Com. Fish.	Sect. 3: FIS 013 (vessel)		Sect. 2: FIS 013 (vessel)	FIS 118 Intro. to Com. Fish.
11:00 a.m.		Sect. 4: FIS 013 (gear lab)	ENG 113		ENG 113
12:00 noon	ENG 113				
1:00 p.m.				PEM 173M First aid	
2:00 p.m.					
3:00 p.m.	Sect. 1: FIS 013 (vessel)	MATH 109A	FIS 118 Intro. to Com. Fish.	MATH 109A	Sect. 3: FIS 013 (gear lab)
4:00 p.m.	Sect. 2: FIS 013 (gear lab)				Sect. 2: FIS 013 (vessel)
5:00 p.m.					

158/159

151



CLASS SCHEDULE: SECOND SEMESTER

	MONDAY	TUESDAY	WEDNESDAY	THURSDAY	FRIDAY
8:00 a.m.					
9:00 a.m.					
10:00 a.m.	SPEECH 101 Free for Scheduling Elective	FIS 121 Fish.Gear I FIS 131 Seamanship	SPEECH 101 Free for Scheduling Elective	FIS 121 Fish.Gear I FIS 131 Seamanship	SPEECH 101 Free for Scheduling Elective
11:00 a.m.					
12:00 noon	FIS 110 Marine Technology	Free for Scheduling Elective	FIS 110 Marine Technology	Free for Scheduling Elective	FIS 110 Marine Technology
1:00 p.m.					
2:00 p.m.	Sect. 1: FIS 014 Sect. 2: FIS 131 Lab Sect. 3: FIS 121 Lab		Sect. 1: FIS 131 Lab Sect. 2: FIS 121 Lab Sect. 3: FIS 014		Sect. 1: FIS 121 Lab Sect. 2: FIS 014 Sect. 3: FIS 131 Lab
3:00 p.m.					
4:00 p.m.					
5:00 p.m.					

CLASS SCHEDULE: THIRD SEMESTER

	MONDAY	TUESDAY	WEDNESDAY	THURSDAY	FRIDAY
8:00 a.m.					
9:00 a.m.	FIS 181 Navigation I	FIS 181 Navigation I Lab all students	FIS 181 Navigation I	FIS 181 Navigation I Lab all students	FIS 135 Fisheries Meteorology
10:00 a.m.	FIS 141 Mar.Eng. Tech. I		FIS 141 Mar.Eng. Tech. I		FIS 141 Mar.Eng. Tech. I
11:00 a.m.					
12:00 noon					
1:00 p.m.	FIS 151 Fish Technology	FIS 161 Marine Electronics		FIS 161 Marine Electronics	FIS 151 Fish Technology
2:00 p.m.		Sect. 1: FIS 141 Lab.	Sect. 1: FIS 161 Lab	Sect. 1: FIS 015	
3:00 p.m.	FIS 151 Fish Technology Lab Sect. A	Sect. 2: FIS 161 Lab	Sect. 2: FIS 015	Sect. 2: FIS 141 Lab	FIS 151 Fish Technology Lab Sect. B
4:00 p.m.		Sect. 3: FIS 015	Sect. 3: FIS 141 Lab	Sect. 3: FIS 161 Lab	
5:00 p.m.					

CLASS SCHEDULE: FOURTH SEMESTER

	MONDAY	TUESDAY	WEDNESDAY	THURSDAY	FRIDAY
8:00 a.m.					
9:00 a.m.	FIS 182 Naviga. II	Sect. 2: FIS 192	FIS 122 Fish.Gear II	Sect. 1: FIS 192	FIS 182 Naviga. II
10:00 a.m.	FIS 122 Fish.Gear II	Fishing Operations	FIS 171 Vessel Technology	Fishing Operations	FIS 182 Naviga. II Lab, All students
11:00 a.m.	FIS 171 Vessel Technology	Lab. Full day at sea	FIS 171 Vessel Technology Lab, All students	Lab. Full day at sea	
12:00 noon					
1:00 p.m.					
2:00 p.m.	FIS 142 Mar. Eng. Tec. II		FIS 142 Mar. Eng. Tec. II		FIS 192
3:00 p.m.	FIS 142 Mar. Eng. Tec. II Lab. Sect. 1	Sect. 1: FIS 122 Lab. Fish.Gear II	FIS 142 Mar. Eng. Tec. II Sect. 1	Sect. 2: FIS 122 Lab. Fish.Gear II	Fishing Operations
4:00 p.m.					
5:00 p.m.					

STUDENT SECTION SIZES FOR LABORATORY SESSIONS

Semester	Course	No. of Sections	No. Each Section
First	FIS 013 Shipboard Work I	4	9 - 10
Second	FIS 014 Shipboard Work II	3	9 - 11
	FIS 121 Fishing Gear I	3	9 - 11
	FIS 131 Seamanship	3	9 - 11
Third	FIS 015 Shipboard Work III	3	7 - 8
	FIS 141 Marine Eng.Tech. I	3	7 - 8
	FIS 151 Fish Technology	2	10 - 12
	FIS 161 Marine Electronics	3	7 - 8
	FIS 181 Navigation I	1	all stud.
Fourth	FIS 122 Fishing Gear II	2	8 - 10
	FIS 142 Marine Eng.Tech.II	2	8 - 10
	FIS 171 Vessel Technology	1	all stud.
	FIS 182 Navigation II	1	all stud.
	FIS 192 Fishing Operations	2	8 - 10

## FACULTY CONTACT HOURS REQUIRED FOR COURSES

Assumes use of class schedules and sections  
given on preceding pages

Course Number	Faculty Member*	Contact Hours		
		lecture	lab.	total
FIS 013	No. 1		12	12
	No. 2		12	12
FIS 014			9	9
FIS 015			9	9
FIS 110		5		5
FIS 118	No. 1	2		2
	No. 2	2		2
FIS 121		2	9	11
FIS 122		2	6	8
FIS 131		2	9	11
FIS 135		2		2
FIS 141		3	9	12
FIS 142		3	4	7
FIS 151		3	4	7
FIS 161		2	9	11
FIS 171		3	2	5
FIS 181		2	4	6
FIS 182		2	2	4
FIS 192		3	16	19

\*Where more than one faculty member is involved in teaching a particular course, the commitment of each is designated here.

APPENDIX D  
INDIVIDUAL EMPLOYMENT HISTORIES OF GRADUATES

1967 STUDENT ENTRY

1. Took position as deckhand aboard offshore lobster vessel; promoted to mate after 3 months; promoted to skipper after 12 months. Left after 18 months employment to become deckhand aboard "high line" Pt. Judith trawler; now engineer aboard that vessel.
2. Deckhand aboard Pt. Judith trawler. Left after 2 months to undertake military service (air force).
3. Deckhand aboard offshore lobster vessel; promoted to mate after 6 months. Left after 18 months to become shellfish warden, Massachusetts.
4. Deckhand aboard offshore trawler, Pt. Judith.
5. Fisheries Development work with Government of Puerto Rico.
6. Trainee Fish Plant manager for U.S. company in Canada; later transferred to a location in the United States for same company.
7. Entered College of Fisheries, University of Washington; completed B.S. 1972. Now working in Sea Grant aquaculture project, University of Rhode Island.
8. Took position as trainee in fish plant management; left after 3 months. No longer connected with the industry.
9. Owner/skipper of 36 ft. lobster fishing vessel.
10. Took position as fisheries technician aboard Antarctic research vessel. Now owner/skipper of vessel in Alaska.
11. Deckhand aboard Pt. Judith fishing vessel. Left after one year, to undertake military service; killed in action, Vietnam.

1968 STUDENT ENTRY

1. Took position as deckhand aboard New Bedford offshore trawler; left (due to health) after 3 months. No longer connected with the industry.
2. Entered Natural Resources Curriculum, University of Rhode Island; completed B.S. 1971. Entered Master of Marine Affairs Program, University of Rhode Island;

165/166

completed M.M.A. 1972. Now Executive Secretary, Atlantic Offshore Fish and Lobster Association. Also operator of 36 ft. lobster vessel.

3. Deckhand aboard trawler at Plymouth, Mass. Left after 6 months and is now mate aboard trawler in Alaska.
4. Owner/skipper of 40 ft. lobster vessel.
5. Wildlife technician, Department of Natural Resources, Rhode Island.
6. Owner/skipper of sports fishing charter vessel in North Carolina.
7. Took position as skipper of shrimp trawler in Florida. Left after 6 months and is now owner/skipper of 86 ft. trawler in Alaska.
8. Took position as deckhand aboard Pt. Judith offshore lobster vessel; left after 12 months and is now crew member aboard Pt. Judith trawler/purse seiner.
9. Took managerial position with lobster distribution company at Pt. Judith; now in insurance business.
10. Owner/skipper of 36 ft. inshore lobster vessel, Maine.
11. Entered Natural Resources Curriculum, University of Rhode Island. Was also part owner/crew of 40 ft. lobster boat and now part-time crew member of Pt. Judith offshore lobster vessel.
12. Part owner/skipper of 40 ft. lobster boat, Rhode Island. Now owner/skipper of 47 ft. shrimp trawler, Florida.
13. Owner/skipper of 40 ft. lobster boat, Maine.
14. Crew member of trawler in Provincetown, Mass. Now mate of 65 ft. trawler, Provincetown.

#### 1969 STUDENT ENTRY

1. Deckhand aboard offshore lobster trawler, Pt. Judith; after three months promoted to engineer.
2. Entered Natural Resources Curriculum, University of Rhode Island.

3. Took position as deckhand aboard trawler, New Bedford. Now deckhand aboard fishing vessel at Pt. Judith.
4. Took position as deckhand aboard New Bedford trawler; after 3 months, promoted to mate.
5. Entered Natural Resources Curriculum, University of Rhode Island.
6. Rigman aboard shrimp trawler, Florida.
7. Returned to previous position as section head at Electric Boat Division of General Dynamics Corp., Groton, Conn.
8. Entered Natural Resources Curriculum, University of Rhode Island; deckhand aboard Pt. Judith fishing vessel during vacations.
9. Mate of 80 ft. party fishing vessel (head boat), Pt. Judith.
10. Owner/skipper of 42 ft. Longliner.
11. Entered Natural Resources Curriculum, University of Rhode Island.
12. Skipper of fishing vessel, Alaska.

1970 STUDENT ENTRY

1. Owner/skipper of 42 ft. inshore fishing vessel, Fishers Island, N.Y.
2. Entered Marine Resources Option, University of Rhode Island.
3. Entered Marine Resources Option, University of Rhode Island.
4. Owner/skipper of 36 ft. lobster vessel, Rhode Island.
5. Owner/skipper of 36 ft. lobster vessel, Pt. Judith.
6. Deckhand, offshore lobster vessel, Pt. Judith.
7. Deckhand, offshore lobster vessel, Pt. Judith.
8. Deckhand, offshore lobster vessel, Pt. Judith.



9. Business trainee in fishing corporation, New Jersey.
10. Entered Marine Resources Option, University of Rhode Island.

## APPENDIX E

### COURSES DROPPED DURING FIRST MAJOR CURRICULUM REVISION

ACCT 5 - Accounting Principles            3 credits

A survey of basic accounting principles and procedures with emphasis on their application to industrial administration of business enterprises.

F&R ECON 40 - Marketing Agricultural Products    3 credits

Examination of role of marketing principles in dairy, poultry and horticultural industries.

MGT 10 - Introduction to Business            3 credits

Nature, philosophy, objectives and scope of the American Business System. Emphasis on the interrelations of the functional areas.

MGT 103 - Personnel and Industrial Relations    3 credits

A study of employer-employee problems at various internal levels and their impact on society. Recruitment, selection, testing, training, wages, manpower requirements, the growth of organized labor, collective bargaining, pension plans, management development programs, public relations and the role of the federal government.

PHY 14 - General Physics            5 credits

Introductory course designed to present basic physics for the student enrolled in the Commercial Fisheries Program.

FISH 2 - Fishing Gear I            5 credits

Introduction to fishing equipment, terminology and techniques. Materials used in fishing gear, netting, net repair and overhaul, net design and cutting.

FISH 3 - Fishing Gear II            3 credits

Detailed study of the bottom and mid-water trawls.

FISH 4 - Fishing Gear III            4 credits

Study of seines, dredges, traps, pots, gillnets and gear used in long lining. Their method of use and maintenance.

FISH 9 - Biology and Conservation      3 credits

Introduction to classification, morphology and anatomy of important fishes and invertebrates. Emphasis on taxonomy, natural history, and management of Western North Atlantic forms. The applied aspects of fisheries science will be introduced.

FISH 12 - Fisheries Hydrography      3 credits

Basic considerations of major hydrographic conditions as related to fishing and fish behavior. Principles and practice of fish finding utilizing hydrographic data and fish finding equipment. Reading and interpretation of scopes and recorders. Exploratory fishing methods.

FISH 20 - Fisheries Problems      1 credit

Investigation of current important problems in the fisheries field. Legislation affecting the fishing fleet and the fish processing industries.

COURSES DROPPED DURING SECOND MAJOR CURRICULUM REVISION

F&R ECON 5 - Economics of Food Production      3 credits

The economic organization of food production and distribution; its relative importance in the U.S. economy. The impact of developing technology on resource demands. Discussion and analysis of important problem areas. Elementary production and pricing principles as guides to decision making by the firm.

PHY 1 & 2 - General Physics      4 credits each

PHY 1 - Mechanics, heat and sound. PHY 2 - optics, electricity, magnetism and modern physics. Non-calculus presentation of fundamental physics.

FISH 19 - Industrial Practicum      5 credits

Supervised period of industrial application. Eight weeks (full time) required aboard commercial fishing vessels participating in the program. Complete records of the vessels and their equipment, a daily log compiled by the students, and reports from the captains to assess performance.

APPENDIX F  
SUMMER COOPERATIVE EDUCATION EXPERIENCE  
LOG BOOK REQUIREMENTS  
STUDENT EVALUATION SHEETS  
LOG BOOK

Vessel \_\_\_\_\_ Student's Name \_\_\_\_\_

INSTRUCTIONS

Operations Log

The first part of the log book contains 65 pages, or one page for each day of your assignment.

Each page will include the day's date and then such information which pertains to the day's operation. The following are some examples of the type of entries.

Steaming Information: Include time left port, weather and tide conditions, general course to grounds, general area to be fished (refer to chart when applicable).

Towing Information: Number of tows for the day, length of tows, best tows, specie caught, day's total by specie, weather during days of fishing.

Gear Information: Length of tow wire used, length of legs and ground wire, net used, extent of gear damage each day.

Lay Days: Days in port should be noted for each day. Include all work done to vessel while in port for each day. (Even though you are not there yourself, find out what has been done in your absence.)

Days of Unloading: Total catch unloaded by specie, price received, copy of settlement.

Log Book Supplement

The second part of the log book includes information to be filled out for each vessel that you are assigned to. There is an example for each area.

1. Net diagram and dimensions.
2. Gear dimensions--wire size, doors, etc.
3. Vessel diagrams overall.
4. Pilot house layout.
5. Engine room layout.
6. Vessel rigging diagram.
7. Life saving and safety equipment.
8. Description of operation--to include what each crewman's job is on deck during setting and hauling operations. Hauling speed, setting speed, speed of engine when hoisting cod end. (Use photographs where possible.)
9. Where possible give the location of each fishing ground in Loran readings or compass bearings and cross-refer these to the map of the fishing grounds of the New England area. Give the depth and nature of the sea bed in each area and indicate which fish species were caught in each place.

173/174

LOG BOOK SUPPLEMENT

1. Net Diagram and Dimensions

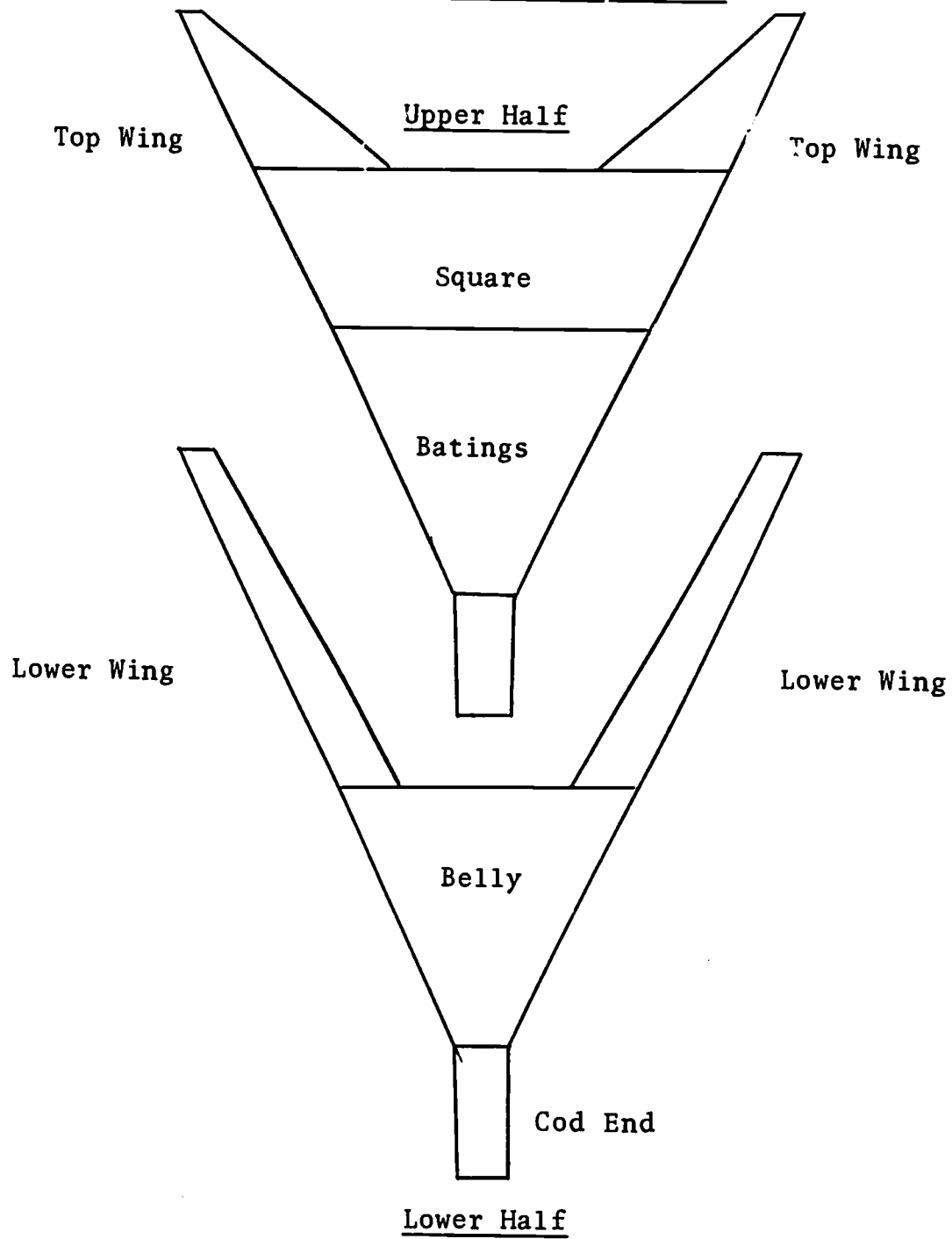

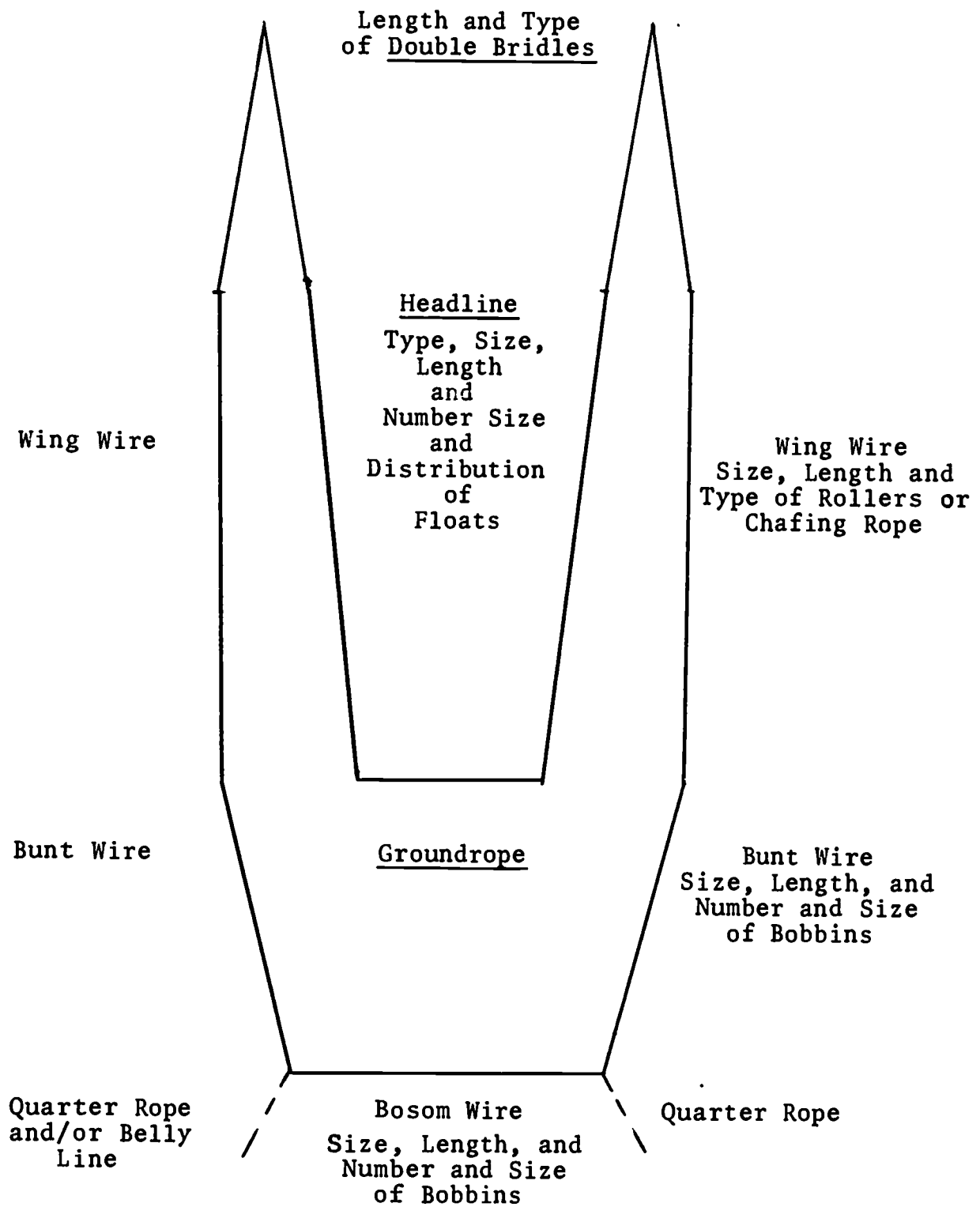

2. Gear Dimensions - Wire Size, Door dimensions, rigging arrangement

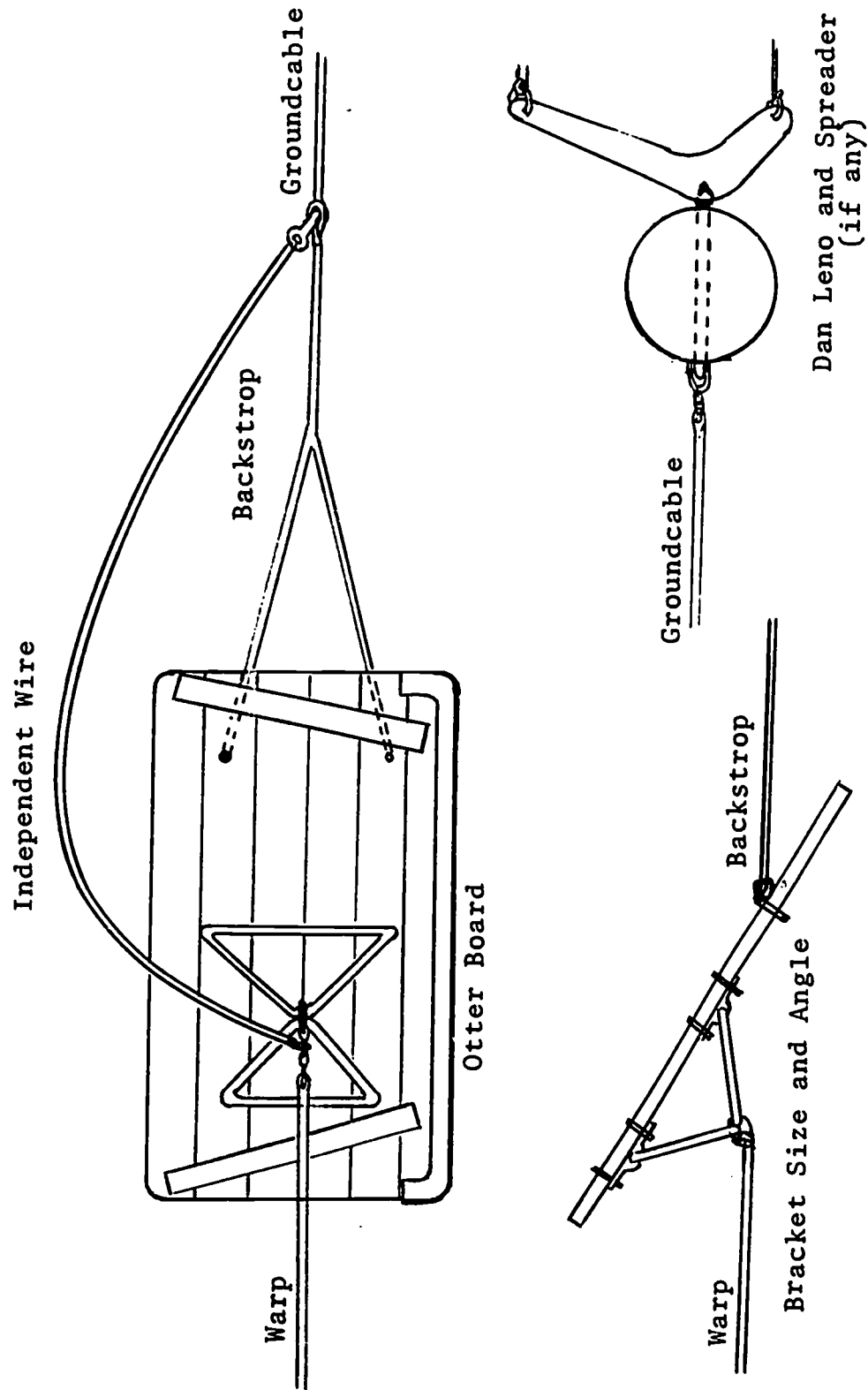

FISHING GEAR NOTES

Net Plans

	Top Wing	Lower Wing	Bunt	Square	Belly	Cod End	Other
--	-------------	---------------	------	--------	-------	------------	-------

Mesh Size \_\_\_\_\_

Twine Size \_\_\_\_\_

Material \_\_\_\_\_

Meshes Wide \_\_\_\_\_

Top End \_\_\_\_\_

Meshes Wide \_\_\_\_\_

Lower End \_\_\_\_\_

Baitings or \_\_\_\_\_

Creasings \_\_\_\_\_

Fly-Meshes \_\_\_\_\_

Double Twine \_\_\_\_\_

Net Rigging

	<u>Length</u>	<u>Size</u>	<u>Material</u>	<u>Size of Floats</u>	<u>Number of Floats</u>
Headrope					

Footrope

	<u>Length</u>	<u>Size</u>	<u>Material</u>	<u>Size of Bobbins</u>	<u>Number of Bobbins</u>
Groundrope					

	<u>Length</u>	<u>Size</u>	<u>Material</u>	<u>Rigging Arrangement</u>
Quarter Ropes				

Belly Lines

	<u>Length</u>	<u>Size</u>	<u>Material</u>	<u>Rigging Arrangement</u>
Double Bridles				

Lower Leg

Upper Leg

Ground Cables

Warps

	<u>Length</u>	<u>Depth</u>	<u>Weight</u>	<u>Bracket</u>	<u>Backstrop</u>
Otter Board					

	<u>Type</u>	<u>Size</u>	<u>Material</u>	<u>Rigging Arrangement</u>
Dan Leno				

Spreader



### 3. Vessel Arrangement diagrams

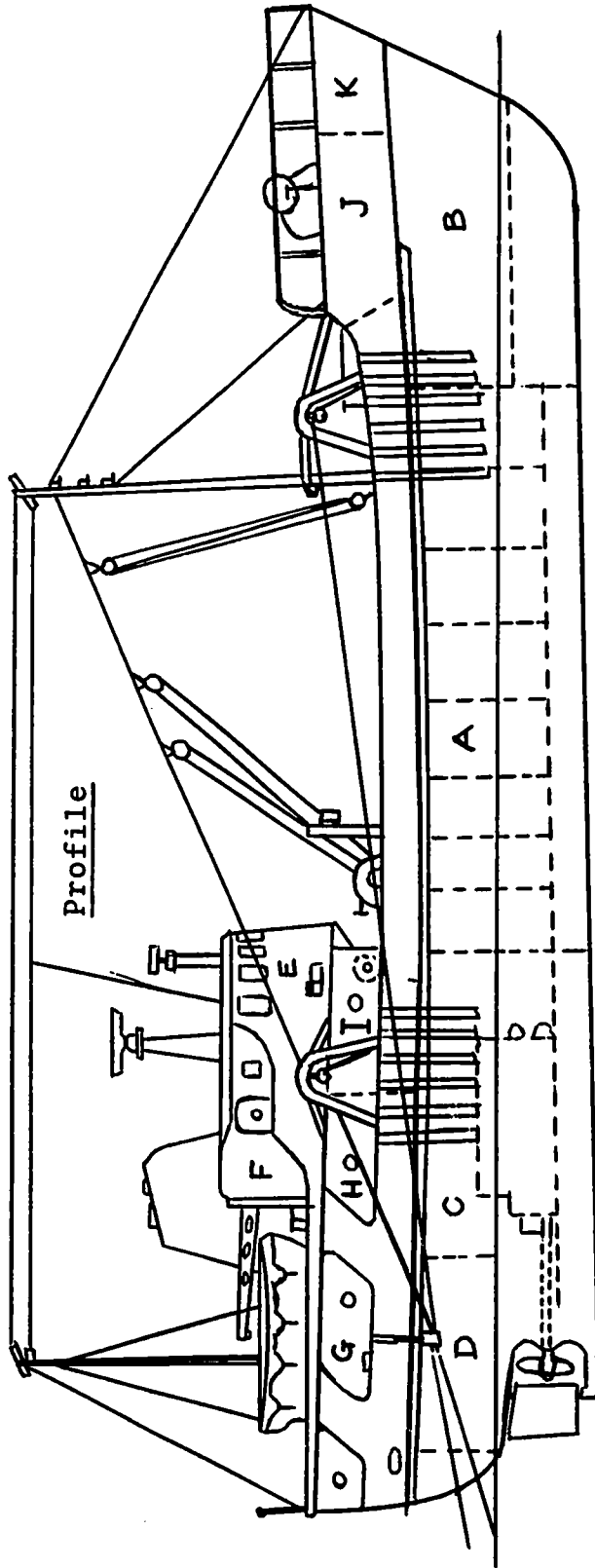

Length Overall 160' Depth 18'  
 Registered Length 141' Draft 13'  
 Hull Construction 3/8" steel plate  
 (2 coats epoxy tarset)  
 Wheelhouse Construction Anodized Aluminum  
 Mast - Tubular steel - Galvanized  
 Fish Hold - Aluminum sheathed  
 Aluminum shelf and penboards  
 5" styrofoam insulation

- A. Fish Hold - 16 pens  
total capacity 180,000 lbs. iced fish
- B. Focsls - berths for 12 men
- C. Engine Room - (separate diagram)
- D. After Quarters for 4 men
- E. Pilot House (separate diagram)
- F. Captain's Stateroom (separate diagram)
- G. Galley
- H. Crew's Mess
- I. Engine compartment for hoister drive engine
- J. Gear storage
- K. Chain locker

### Deck Arrangement

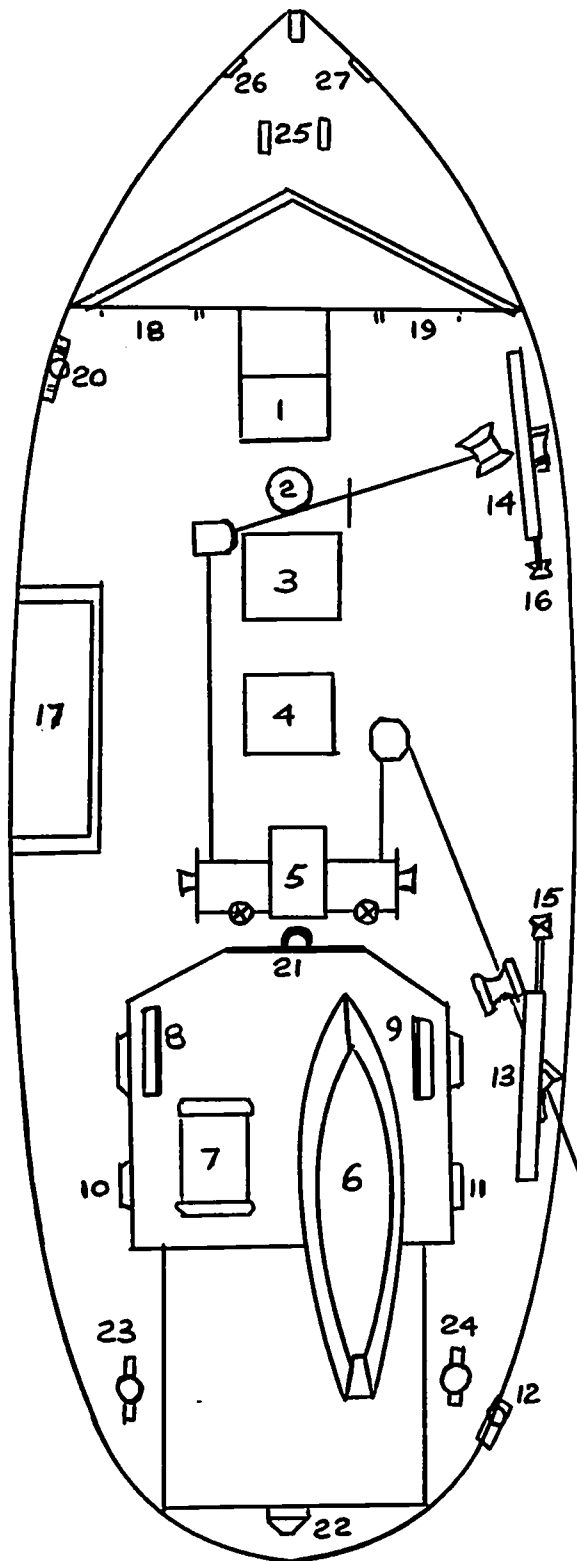

Length overall 83'  
Breadth " 20'

1. Fwd. companionway
2. Fwd. mast
3. Fwd. Hatch
4. Aft. Hatch
5. Winch  
(500 fathom 5/8 wire)
6. Dory 17' O.A.
7. 6 man life raft
8. Port running light
9. Stbd. running light
10. Port life ring
11. Stbd. life ring
12. Hook up block
13. Aft. gallows
14. Fwd. gallows
15. Aft. quarter block
16. Fwd. quarter block
17. Lobster box  
(2,000 lb. cap.)
- 18.) Fwd. entrances
- 19.) to whale back
20. Anchor  
900 lb. Danforth)
21. Aft. mast
22. Stern light
- 23.) Stern bits
- 24.) Stern bits
25. Fwd. bits
26. Bow chocks

Below Deck Layout

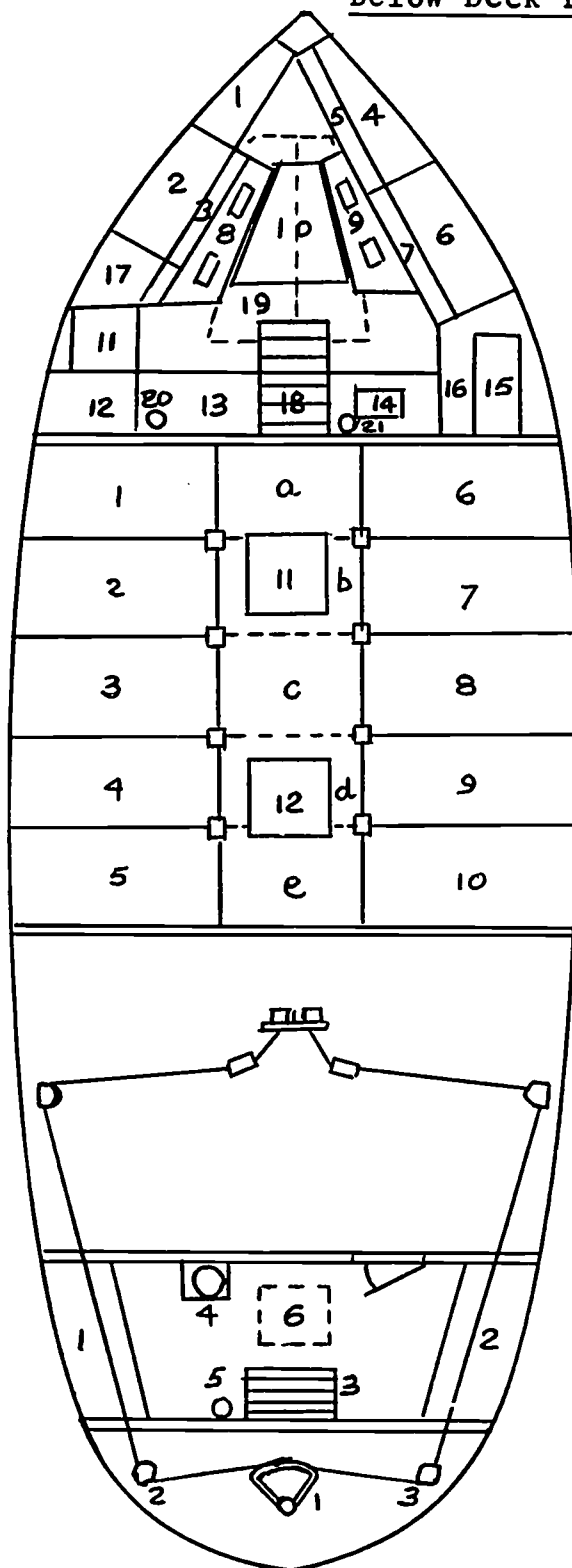

Fo'c's'le:

- 1-7. Bunks
- 8-9. Lockers & seats
- 10. Table
- 11. Stove
- 12. Cupboard
- 13. Counter, cupboard under
- 14. Sink, refrigerator power supply under
- 15. Hot water tank (500 gal.) (under)
- 16. Refrigerator
- 17. Clothes locker
- 18. Companionway
- 19. 2 600 gal. water tanks (below focsle floor)
- 20-21 Fire extinguishers

Fish Hold

- 1-10. Fish pens cap. 4,500 lb. ea. (iced fish)
- 11-12 Hatches
- Icing instructions:  
fill pens 2,3,4,5,7,8 & 9  
fill slaughterhouse (center section) b,c,d.  
Total ice for trip 18 tons

After Stateroom

- 1-2. Bunks
- 3. Companionway
- 4. Stove (engine room & pilot house)
- 5. Fire extinguisher
- 6. Access hatch to stuffing box.

Lazarette

- 1. Quadrant
- 2-3. Lead blocks

#### 4. Pilot House Layout

Include details of all electronic and mechanical aids to fishing and navigation; e.g., Radar, Loran, sounders, auto pilot, engine controls, extension gauges, etc.

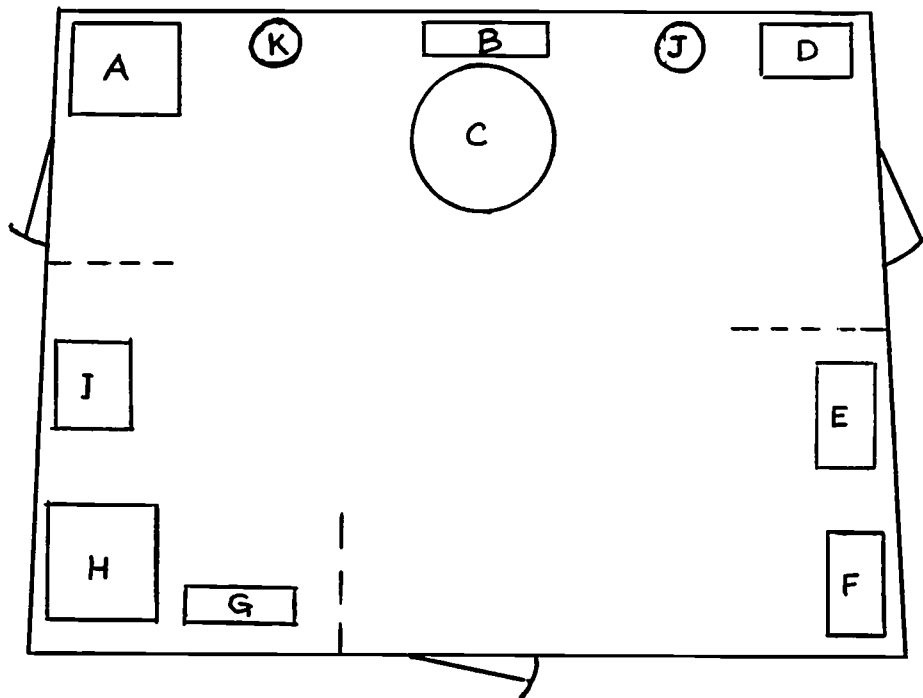

Item	Manufacturer	Power Req.	Price or Rental	Remarks
A				
B				
C				
D				
E				
F				
G				
H				
I				
J				
K				

## 5. Engine Room Layout and Equipment

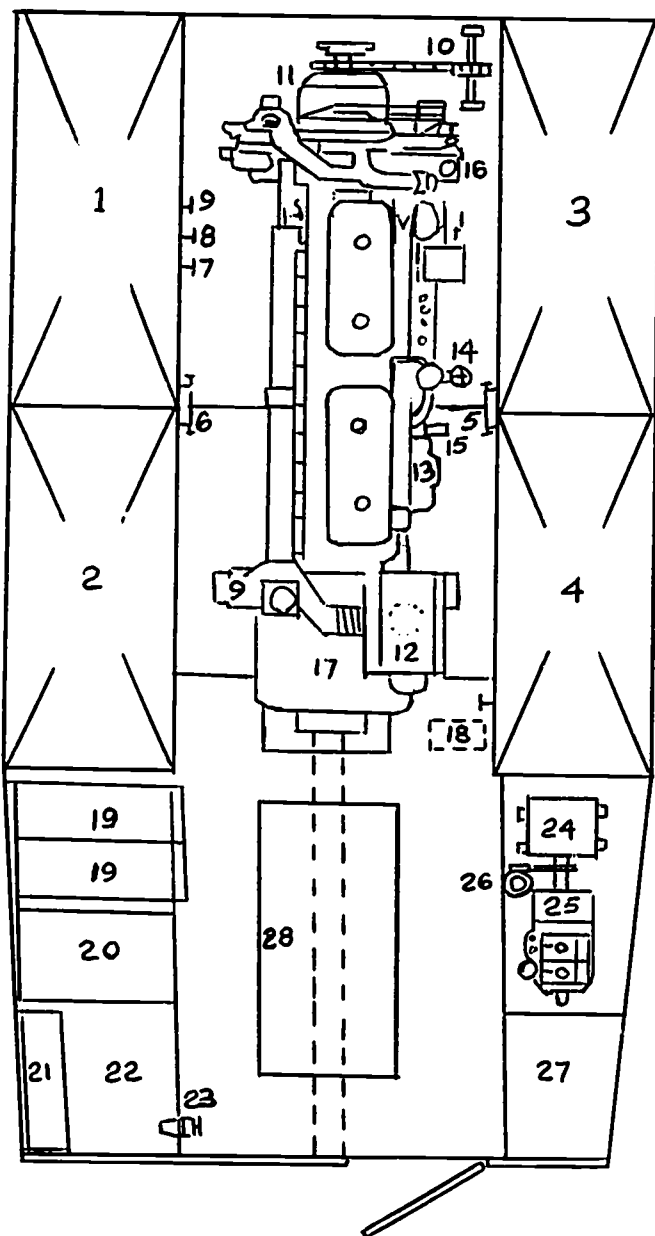

- 1, 2, 3, & 4 Fuel Tanks
- #1. 1200 gal.
- #2. 800 gal.
- #3. 1200 gal.
- #4. 800 gal.
- 5-6 Tank valves to engine
- 7. Focsle Bilge valve
- 8. Engine room valve
- 9. Fish hold valve
- 10. Hoister drive
- 11. Front end power take-off
- 12. Turbocharger
- 13. Lube oil filters
- 14. Oil filler
- 15. Dip stick
- 16. Fresh water filler cap
- 17. Reduction gear and clutch
- 18. Sea water strainer and clutch
- 19. 4 - 8 volt batteries 2 over 2
- 20. Lube oil tank 75 gal. cap.
- 21. Tool box
- 22. Tool & work bench
- 23. Vice
- 24. Generator
- 25. Auxiliary
- 26. Bilge pump
- 27. Engine room storage locker
- 28. Hatch to shaft & inside stuffing box

Main Engine Information

Make & Model of Engine \_\_\_\_\_ No. of Engines \_\_\_\_\_

Horsepower, Continuous \_\_\_\_\_ at \_\_\_\_\_ R.P.M.'s

Turbocharged, Turbocharged & Aftercooled, Rotary Blower,  
Naturally aspirated.

Dimensions: Length \_\_\_\_\_ Height from Bed \_\_\_\_\_

No. of Cylinders \_\_\_\_\_

Bore and Stroke \_\_\_\_\_

Fuel System: (Ex., Bosch, CAT, Cummins-P.T., etc.)  
\_\_\_\_\_

Exhaust Pipe Size (Inside Dia.) \_\_\_\_\_

Muffler used (Type and Make) \_\_\_\_\_

Fresh Water Cooling Pump Make & Size \_\_\_\_\_

Sea Water Cooling Pump Make & Size \_\_\_\_\_

Model No. of Lube Oil Filter \_\_\_\_\_

Model No. of Fuel Oil Filters \_\_\_\_\_

Brand Lube Oil Used \_\_\_\_\_

Comments on Main Engine

Example: Is power adequate for vessel? Present estimated condition of the engine? Extent of smoke? What color?

Any other comments which you may feel are pertinent to the main engine:

Reduction Gear Information

Make & Model No. \_\_\_\_\_

Reduction \_\_\_\_\_

Hydraulic, Mechanical, Direct Reversible

Shaft Size \_\_\_\_\_ Material Used \_\_\_\_\_

Wheel Size \_\_\_\_\_ Make \_\_\_\_\_

Main Alternator or Generator Information

Kilowatt Output \_\_\_\_\_ at \_\_\_\_\_ R.P.M.'s

Amperage \_\_\_\_\_

Make & Model \_\_\_\_\_

Ship's Electrical System

Voltage \_\_\_\_\_ A.C. D.C. \_\_\_\_\_

Battery Capacity \_\_\_\_\_ Amperage Hours \_\_\_\_\_

No. of Batteries \_\_\_\_\_ One or Two Banks \_\_\_\_\_

Make of Batteries \_\_\_\_\_

Auxiliary Engine Information

Make & Model of Engine \_\_\_\_\_ No. of Engines \_\_\_\_\_

Horsepower, Continuous \_\_\_\_\_ at \_\_\_\_\_ R.P.M.'s

Air Cooled, Water Cooled (Fresh), Water Cooled (Sea)

Dimensions: Length \_\_\_\_\_ Height From Bed \_\_\_\_\_

No. of Cylinders \_\_\_\_\_

Bore & Stroke \_\_\_\_\_

Fuel System C.A.V., GM, CAT

Exhaust Pipe Size (Inside Dia.) \_\_\_\_\_

Model Number of Lube Oil Filter \_\_\_\_\_

Model Number of Fuel Oil Filter \_\_\_\_\_

Lube Oil Used In Auxiliary \_\_\_\_\_

Comments on Auxiliary Engine:

Any additional information which pertains to engines and equipment should be written up on additional pages provided with this section.

6. Vessel Rigging Diagram

Draw side elevation of vessel indicating all standing rigging to masts and running rigging to booms and blocks. State dimensions of blocks, size of type of rope and nature of tackles.

7. Life Saving and Safety Equipment

Draw planned view of decks showing position and type of all life saving and fire fighting equipment. (Include pumps for fire hoses, etc., in engine room diagram.)

8. Description of Fishing Operation

The description of the operation of the gear can be done by a written description as well as photographs and sketches for each part of the hauling and setting operation.

9. Fishing Grounds

Where possible give the location of each fishing ground in Loran readings or compass bearings and cross-refer these to the map of the fishing grounds off the New England area. Give the depth and nature of the sea bed in each area and indicate which fish species were caught in each place.



## STUDENT EVALUATION

### Part 1: General Evaluation

1. Can the student be depended on to carry out an assignment?

Excellent \_\_\_\_\_ Good \_\_\_\_\_ Average \_\_\_\_\_ Poor \_\_\_\_\_

Comments:

2. Is he thorough in carrying out an assignment?

Excellent \_\_\_\_\_ Good \_\_\_\_\_ Average \_\_\_\_\_ Poor \_\_\_\_\_

Comments:

3. Is he punctual with regard to arriving for trips and turning out for watches?

Excellent \_\_\_\_\_ Good \_\_\_\_\_ Average \_\_\_\_\_ Poor \_\_\_\_\_

Comments:

4. Does he carry out all assignments with enthusiasm?

Excellent \_\_\_\_\_ Good \_\_\_\_\_ Average \_\_\_\_\_ Poor \_\_\_\_\_

Comments:

5. Does he fit in with the members of the crew?

Excellent \_\_\_\_\_ Good \_\_\_\_\_ Average \_\_\_\_\_ Poor \_\_\_\_\_

Comments:

6. Does he work well with members of the crew?

Excellent \_\_\_\_\_ Good \_\_\_\_\_ Average \_\_\_\_\_ Poor \_\_\_\_\_

Comments:

7. How would you rate his overall conduct and behavior?

Excellent \_\_\_\_\_ Good \_\_\_\_\_ Average \_\_\_\_\_ Poor \_\_\_\_\_

Comments:

8. Is he able to adjust to life at sea?

Excellent \_\_\_\_\_ Good \_\_\_\_\_ Average \_\_\_\_\_ Poor \_\_\_\_\_

Comments:

9. Is student acquiring necessary speed and efficiency on deck?

Excellent \_\_\_\_\_ Good \_\_\_\_\_ Average \_\_\_\_\_ Poor \_\_\_\_\_

Comments:

10. Does he assist other crew members in their work; for example, cook, engineer, etc.?

Excellent \_\_\_\_\_ Good \_\_\_\_\_ Average \_\_\_\_\_ Poor \_\_\_\_\_

Comments:

11. Do you feel student has a genuine interest in fisheries?

Excellent \_\_\_\_\_ Good \_\_\_\_\_ Average \_\_\_\_\_ Poor \_\_\_\_\_

Comments:

12. Is he willing to accept instruction?

Excellent \_\_\_\_\_ Good \_\_\_\_\_ Average \_\_\_\_\_ Poor \_\_\_\_\_

Comments:

13. With further years of experience, do you feel that this student is capable of attaining skipper status?

Excellent \_\_\_\_\_ Good \_\_\_\_\_ Average \_\_\_\_\_ Poor \_\_\_\_\_

Comments:

## Part 2: Technical Proficiency

1. What is student's potential proficiency in the following areas?

A. Fish handling

Excellent \_\_\_\_\_ Good \_\_\_\_\_ Average \_\_\_\_\_ Poor \_\_\_\_\_

Comments:

B. Maintenance of nets and gear

Excellent \_\_\_\_\_ Good \_\_\_\_\_ Average \_\_\_\_\_ Poor \_\_\_\_\_

Comments:

C. Rope and wire splicing

Excellent \_\_\_\_\_ Good \_\_\_\_\_ Average \_\_\_\_\_ Poor \_\_\_\_\_

Comments:

D. Engine and deck gear maintenance

Excellent \_\_\_\_\_ Good \_\_\_\_\_ Average \_\_\_\_\_ Poor \_\_\_\_\_

Comments:

E. Steering and watch keeping

Excellent \_\_\_\_\_ Good \_\_\_\_\_ Average \_\_\_\_\_ Poor \_\_\_\_\_

Comments:

F. General navigation

Excellent \_\_\_\_\_ Good \_\_\_\_\_ Average \_\_\_\_\_ Poor \_\_\_\_\_

Comments:

G. Use of electronic aids to fishing and navigation

Excellent \_\_\_\_\_ Good \_\_\_\_\_ Average \_\_\_\_\_ Poor \_\_\_\_\_

Comments:

H. Ability in vessel management--example: logbook,  
organizing work, etc.

Comments:

2. Would you recommend this student to any other employer?
3. Does having one of our students aboard the vessel cause inconvenience to yourself or disrupt the crew in any way?

APPENDIX G  
COMPLETE COURSE DESCRIPTIONS

FIS 013 - SHIPBOARD WORK I

1. Credits: 2 Laboratory hours: 6

Instructor: Stout, Hillier, Sainsbury

2. Description

Work aboard training vessels in port and at sea. Experience is gained in operating vessels, their equipment and a principal method of fishing.

3. Subject Outline

Part 1 - Vessel Operation

a. Vessel orientation

Directions within and outside vessel  
Relative bearings  
Nomenclature  
Vessel motion  
Equipment

b. Engineering systems

Propulsion system  
Electrical system  
Water systems  
Fuel systems  
Pumping systems  
Hydraulic system

c. Vessel handling

Mooring and anchoring  
Helmsmanship  
Deckwork

d. Piloting

Rules of the road  
Use of navigation charts  
The log book

e. Safety procedures

Lifesaving equipment  
Fire fighting equipment  
Emergency procedures  
Use of radio

f. Fishing operations

Operation with net drum or quarter ropes  
Safety while fishing

Part 2 - Net and Boat Work

a. Introduction

Tools and equipment used in twinework  
Safety in twinework  
Types of twine and rope used in nets and rigging  
Basic knots for shipboard and twine work

- b. Knitting twine
  - Straight web
  - Baitings, creasings, and selvage meshes
- c. Mending twine
  - Cutting and trimming
  - Use and elimination of three leggers
  - Side meshes and pick-ups
  - Mending a simple hole
  - Run of twine
  - Patching
- d. Small boat handling
  - Launching and retrieving a dory
  - Rowing
  - Lifesaving

#### 4. Laboratory Projects

##### Part 1 - Vessel Operation

Week 1 - Vessel orientation and nomenclature--directions within and from vessel, relative bearings from vessel, nomenclature for external hull, superstructure, rigging, interior, vessel motion, deck machinery, outfit stores and tools, instruments and accessories, lifesaving and firefighting equipment.

Week 2 - Propulsion and electrical systems--main engine, engine requirements, engine outputs, controls, monitoring, engine check lists, a.c. power plant.

Week 3 - Systems safety and upkeep--the operation, precautions, checks and maintenance of the potable water, sanitary, salt water cooling systems.

Week 4 - Systems safety and upkeep--the operation, precautions, checks and maintenance of the fuel oil, bilge pumping, electrical, hydraulic systems.

Week 5 - Anchoring--anchoring to ground, ground tackle, evolutions, precautions, use of sea anchor; mooring--mooring lines, line handling, maneuvering, precautions.

Weeks 6 & 7 - Shiphandling--helm orders and responses, engine orders, maneuvering, environmental effects, precautions, man-overboard procedure.

Week 8 - Rules of the road--international regulations for preventing collision at sea, inland rules, steering and sailing rules, fog signals, speed in fog, distress signals.

Week 9 - Navigation--synopsis for daytime operation, equipment, publications, charted information, aids, procedure, notations; log keeping--reasons, procedure, precautions.

Week 10 - Deckwork--deck seamanship, machinery, running rigging, stores, procedures, terms and signals, precautions. Radio--radio telephone communications, equipment, licenses, regulations, frequency/channel usage, procedure, phonetic alphabet, log book, precautions.

Week 11 - Introduction to fishing--procedures and precautions for setting and hauling gear using either drum or quarter rope handling; two or more tows are made

Weeks 12, 13 & 14 - Fishing--several tows made during each session, students rotating positions to gain maximum possible experience.

## Part 2 - Net and Boat Work

Week 1 - Introduction to twinework--types of nets, types of twine and rope, tools used in twinework, threading twine needles, sharpening and use of twine knives, safety while working with twine.

Week 2 - Knots and mending--basic knots used in the construction and mending of twine and in work aboard a vessel, introduction to twine mending, the reasons and manner of work at sea.

Week 3 - Knitting twine--tools used, making a twine scale, beginning to make web from twine, setting up a piece of web, practice in knitting straight web.

Week 4 - Knitting twine--continuation of knitting straight web, shaping web from straight to tapering, use of baitings and creasings, selvedge meshes.

Week 5 - Knitting hammock--preparation of test piece, normally a hammock, using all the previously learned knitting skills.

Week 6 - Basic twine mending--preparing a hole for mending, the use of three leggers, side meshes and pick-ups, trimming knots and removing from pick-ups, holding mesh and correct method of passing needle through the meshes.

Week 7 - Further twine mending--continuation of twine mending to include explanation and recognition of how the twine runs.

Weeks 8, 9 & 10 - Twine mending--practice in mending holes of different types in various twine and mesh.

Weeks 11 & 12 - Mending and patching--the use of a patch, patching procedures. Practice in twine mending and patching.

Weeks 13 & 14 - Handling a dory--launching, handling, rowing, retrieving a dory. Lifesaving from a dory.

### 5. Textbooks

No suitable textbooks are available.

### 6. Handouts

In Part 1 of the course, mimeographed sheets prepared by the instructor are provided weekly as appropriate.

### 7. References and Additional Reading Material

a. Rope Knowledge for Riggers by Columbian Rope

- b. The New Boatman's Manual, 3rd ed., 1962, by C. D. Lane, pub. by W. W. Norton & Co., Inc.
  - c. Useful Knots and How To Tie Them, 1946, by Plymouth Cordage.
  - d. Rules of the Road, International - Inland, U.S. Coast Guard, CG-169, 1967.
  - e. How to Make and Set Nets by John Garner, pub. by Fishing News (Books) Ltd., London.
8. Visual Aids and Other Materials
- a. Models of various fishing vessel types
  - b. Models of various net types
  - c. Film - Net Mending, National Marine Fisheries Service
9. Equipment
- Part 1
- a. Training vessel, ready for sea
  - b. Bottom trawl rigged to suit configuration of training vessel
- Part 2
- a. Beams or wire rigged for hanging web
  - b. Fixed and portable stanchions for stretching web
  - c. Chain falls or other means for setting knots
10. Supplies
- Part 1
- a. Vessel log book
  - b. Medium scale local area chart
  - c. 2 large scale local area charts
  - d. 2 tubes grease
  - e. 15 gals. lubricating oil
  - f. 5 gals. hydraulic oil
  - g. 300 gals. diesel fuel
  - h. 5 lbs. cotton rags
  - i. Brushes, mops and cleaning materials, including hand cleaner
- Part 2
- a. 1 twine knife for each student
  - b. 3 twine needles (jumbo, large, small) for each student
  - c. 12 sharpening stones
  - d. 300 sq. ft. standard size web for each student
  - e. 70 lbs. of standard mending twine for each student
  - f. Assorted balls of various twines.

11. Instructor's Teaching Arrangement

The course is divided into two distinct parts taught by separate instructors. The two parts are interrelated in that they provide a practical introduction to the operation of a fishing vessel and the work of a fisherman. The course provides the knowledge and skills needed by students in order to undertake the work of later courses in the program.

One afternoon laboratory session each week is devoted to Part 1, Vessel Operation. During the first weeks of the teaching work, the instructor spends approximately half an hour at the beginning of each class session introducing the subject material, following which students carry out practice in the various activities covered. During this stage of the course, weekly quizzes are used to promote student retention of the necessary basic knowledge. Later sessions of this part of the course are devoted to student practice in the various techniques, materials and apparatus of the subject, with the instructor providing demonstration and criticism.

A second afternoon laboratory session each week is devoted to Part 2, which is mainly concerned with twine work and in assisting students to gain necessary skills in manipulation of twine and web. Following initial group demonstrations by the instructor during the first weeks, individual attention is given to each student at every stage of progression. The production of test pieces is required at intervals throughout.

For each part of the course, students are required to complete a laboratory notebook covering the skills and operations undertaken. This forms a self-produced text for future reference.

In order to ensure adequate opportunity for individual students to practice skills and operations under sufficient supervision and to attain a satisfactory level of proficiency in them, small group instruction has been found essential, maximum ten students per group.

12. Method of Grading

Each part of the course carries equal weight:

<u>Part 1</u> - Quizzes	25%
Final exam	10%
Laboratory notebook	15%
<u>Part 2</u> - Practical tests	30%
Final exam and notebook	10%
Knitting hammock	10%



FIS 014 - SHIPBOARD WORK II

1. Credits: 1 Laboratory hours: 3  
Instructor: Sainsbury
2. Description  
Work aboard training vessels at sea and in port. Experience is gained in rigging and working common gear used in the commercial fishing industry.
3. Subject Outline
  - a. Fishing methods
    - Stern drum trawling
    - Stern trawling using quarter ropes
    - Scallop dredging
    - Quahog dredging
  - b. Navigation
    - Plotting courses using variation and deviation
    - Tuning and use of radar
    - Use of depth sounder
    - Position fix using pelorus
    - Position fix using radar with variable range marker
    - Keeping the log
  - c. Engineer's Work
    - Pre-voyage checks of engines and systems
    - Running checks of engines and systems
    - Operation of hydraulic system
    - Post-voyage checks of engines and systems
    - Keeping the engineer's log
  - d. Vessel Handling
    - Leaving and returning to berth
    - Pilotage
    - Steering and maneuvering on passage and when fishing
    - Maneuvering when setting and retrieving gear
    - Maneuvering to retrieve gear following a foul set or hang-up.
  - e. Deckwork
    - Handling mooring lines
    - Net mending
    - Rigging and changing nets and gear
    - Handling of nets and gear while fishing
    - Operation of winch
    - Handling, cleaning and storage of fish
    - Deck cleanup
  - f. Safety
    - Safety equipment checks
    - Man-overboard procedure
    - Use of radio

4. Laboratory Projects

Week 1 - Rigging the bottom trawl for stern drum trawling. Initial instruction in stern drum trawling; detailing students to positions as skipper, mate, engineer, navigator, and deckhands (to be changed each week in rotation).

Weeks 2,3,4,5,6 - Practice in stern drum trawling. Each week the vessel leaves berth and proceeds to fishing grounds where two tows of 30 to 40 minutes duration are made. Vessel then returns to berth and unloads fish.

Week 7 - Instruction and practice in Quahog dredging aboard the State of Rhode Island Department of Natural Resources research vessel.

Week 8 - Changeover vessel to undertake stern trawling with quarter ropes. Removal of drum, rigging of kelly eye and stopper arrangement. Initial instruction in use of method while fishing.

Weeks 9,10,11,12 - Practice in stern trawling using quarter ropes for handling net. Vessel leaves berth, proceeds to fishing grounds where two tows of 30 to 40 minutes duration are made. Vessel returns to berth and unloads fish. Man-overboard procedure performed on one or more occasions.

Week 13 - Changeover vessel to undertake scallop dredging using a single dredge from the stern. Instruction and practice in use of the method while fishing

5. Equipment

- a. Fully operational training vessel
- b. Set of standard bottom trawl doors
- c. Three bottom trawls of different sizes and designs
- d. Net drum
- e. Rigging for kelly eye and stopper arrangement
- f. Rigging for net drum arrangement
- g. Standard six foot scallop dredge
- h. White line depth recorder
- i. Radar with variable range marker
- j. Pelorus

6. Supplies

- a. Assorted wire as required
- b. Assorted rope as required
- c. Assorted twine for net repairs
- d. Fishing and net hardware
- e. Deck supplies: baskets, boxes, knives, picks, stones.

7. Instructor's Teaching Arrangement

This course is entirely practical. Students undertake all rigging, unrigging and care of nets, vessel

and other gear, and are responsible for entire operation of the vessel with the instructor acting as advisor and taking direct responsibility only in the event of danger. The maximum number of students aboard the vessel is restricted to seven, who rotate duties as skipper, mate, navigator, engineer and deckhand(3) each week. Each student is required to complete a formal laboratory notebook containing details of the vessel and gear arrangement and operation for all fishing methods, and the work of each crew position. In addition, a rough log listing the grounds fished, catch and other details is required for each trip. A more complete outline of the manner in which this course is operated will be found in Appendix M, where the section "A day on the GAIL ANN" describes a typical day's trip as seen by a student.

8. Method of Grading

- |   |     |
|---|-----|
| a. Evaluation of performance in port and at sea | 50% |
| b. Final examination                            | 20% |
| c. Laboratory notebook and log                  | 30% |

FIS 015 - SHIPBOARD WORK. III

1. Credits: 1 Laboratory hours: 3  
Instructor: Hillier
2. Description  
Work aboard training vessels at sea and in port.  
Rigging, working and evaluation of fishing gear.
3. Subject Outline
  - a. Purse seining
    - Rigging vessel
    - Rigging net and gear
    - Fishing operation
    - Unrigging vessel
    - Work on seine
  - b. Twin rig trawling
    - Rigging vessel
    - Rigging nets and doors
    - Fishing operation
    - Unrigging vessel and care of nets
  - c. Midwater trawling
    - Rigging vessel
    - Rigging nets and doors and electronic equipment
    - Fishing operation
    - Unrigging vessel and care of gear
  - d. Drum trawling
    - Rigging vessel with drum
    - Rigging net and doors
    - Fishing
4. Laboratory Projects

Week 1 - Rigging for purse seining--installation of power block, purse drum, fair leads, purse davit and blocks, purse ring tray. Preparation of seine skiff. Rigging the purse seine net including purse line, rings, wing lines, over-run line. Putting net aboard vessel

Week 2 - Initial instruction in purse seining operation--explanation of various crew positions, and detailing of each student to a particular job. Spotting fish. At least one set is made whether or not fish is spotted.

Weeks 3,4,5 - Practice in purse seining--at least two sets are made during each session, if possible on spotted fish, students changing jobs on each occasion, to provide experience in all positions.

Week 6 - Changeover to twin-rig trawling--seine removed from vessel, placed to dry, unrigged and repaired as required. Power block, purse drum and associated equipment removed and stored. Twin booms

rigged, shrimp trawls and doors placed aboard vessel and rigged.

Week 7 - Initial instruction in twin-rig trawling-- explanation of method for setting and hauling of nets and doors. Two or three short tows are made using the twin-rig configuration.

Weeks 8,9 - Practice in twin-rig trawling--several tows are made each session using the twin-rig arrangement with students changing crew positions to gain experience in the various operations involved.

Week 10 - Changeover to midwater trawling--twin-rig nets, doors and booms are removed from vessel and stored. Midwater trawl, Suberkrub doors and associated electronic equipment installed aboard vessel.

Week 11 - Initial instruction in midwater trawling-- explanation of setting, hauling, use of weights, warp length and vessel speed to control net depth. Control of net using headline transducer information. Two or three short tows are made.

Week 12 - Practice in midwater trawling--several tows are made with students changing crew positions to gain experience in the operations involved.

Week 13 - Changeover vessel--midwater trawl, doors and equipment removed. Net drum and standard bottom trawl rigged aboard, fishing with bottom trawl.

Week 14 (if available) - Bottom trawling--several tows are made with the bottom trawl on various types of bottom with the net performance being assessed.

## 5. Equipment

- a. Fully operational training vessel
- b. Standard menhaden seine with end bunt
- c. Power block
- d. Purse davit and blocks
- e. Purse line drum
- f. Purse ring tray
- g. Seine skiff with outboard motor
- h. Twin-rig outrigger booms
- i. Two sets of shrimp doors
- j. Two bottom trawls rigged for twin boom use
- k. Set of two square meter Suberkrub doors
- l. Midwater trawl
- m. Headline transducer and display system
- n. Sonar unit
- o. Whiteline depth recorder
- p. Net drum
- q. Set of standard bottom trawl doors
- r. Bottom trawl

## 6. Supplies

- a. Assorted wire as required
- b. Assorted rope as required

- c. Assorted twine for net repair
- d. Fishing and net hardware

7. Instructor's Teaching Arrangement

This course is entirely practical. Students undertake all rigging, unrigging and care of nets, vessel and other gear. When at sea, students operate the vessel, rotating crew positions to provide as wide a range of experience as possible. In all sessions, as appropriate, instruction and practice is given on the care of the catch, cleaning fish, icing fish and maintenance of gear. Each student is required to complete a formal laboratory notebook containing details of the vessel and gear arrangement, fishing procedures, and operations for each session.

8. Method of Grading

- a. Evaluation of performance in port and at sea 50%
- b. Final examination 20%
- c. Laboratory notebook 30%

FIS 110 - MARINE TECHNOLOGY

1. Credits: 5 Lecture hours: 5  
Instructor: Taber
2. Description  
Application of basic principles of statics, dynamics, heat, light, sound, magnetism and electricity to problems encountered in vessel operation, fishing gear, navigation, fish finding, handling and storage of fish, engineering and electrical systems.
3. Subject Outline
  - a. Statics
    - Vectors and scalars
    - Resolution of forces
    - Moments
    - Equilibrium of systems
    - Two dimensional force systems
    - Application of equilibrium to trawling and deck machinery
    - Friction
  - b. Strength of materials
    - Stress and strain
    - Hooke's law
    - Properties of materials
    - Thermal stresses
    - Safety factors
  - c. Dynamics
    - Velocity, acceleration, force, momentum
    - Energy, work, power
    - Friction and efficiency
    - Relative motion
    - Introduction to simple harmonic motion
  - d. Hydrostatics and hydrodynamics
    - Archimedes principle
    - Pressure
    - Principles of fluid flow
    - Bernoulli's equation
    - Viscous flow, Reynolds Number
  - e. Heat
    - Heat transfer
    - Convection, conduction, radiation
    - Introduction to refrigeration
  - f. Electricity
    - Simple circuits using Ohm's law
4. Lecture Outlines  
Week 1 - Review of trigonometry. Vectors and scalars-- addition and subtraction of vector quantities.

Week 2 - Vector forces--resolution of vector quantities, use of vectors in the resolution of problems with a number of concentric forces.

Week 3 - Moments--principle of moments, the couple, transformation of forces, problems using systems with nonconcurrent forces.

Weeks 4,5 - Systems in equilibrium--the freebody diagram and its use, including friction, particular application to the trawling system and operation of fishing vessel deck machinery.

Week 6 - Strength of materials--definitions and properties of materials, Hooke's law, stress-strain diagram, problems involving shear and tensile stress.

Week 7 - Strength of materials--stresses and strains due to temperature changes and deformations, safety factors, problems involving fishing operations.

Week 8 - Velocity, acceleration, equations of rectilinear motion with constant acceleration, problems found in fishing operations.

Week 9 - Relative velocity, impulse and momentum, application to problems in navigation and conditions met with while fishing, such as "hanging up."

Week 10 - Work done, kinetic and potential energy, power, units of energy and power. Problems involving conversion of energy to work having particular application to pumps and power transmission; friction and efficiency in transmission of power; the definition of simple harmonic motion and its application to vessels and their motions.

Week 11 - Hydrostatics--pressure and pressure gauges Archimedes principle and application to vessels. Hydrodynamics--introduction to fluid flow, the continuity equation.

Week 12 - Hydrodynamics--the derivation and use of Bernoulli's equation, application to fluid transmission and in fishing operations, the effects of viscosity, Reynolds Number.

Week 13 - Principles of heat transfer, convection, conduction, radiation, application to hold storage conditions; elements of refrigeration.

Week 14 - Introduction to electricity--definitions and simple circuit problems using Ohm's law.

5. Textbook

University Physics, 4th ed., 1970, by Sears and Zemansky, pub. by Addison-Wesley Pub. Co.

6. Handouts

Mimeographed sheets are issued as a supplement to the text, with particular reference to the application of physical principles to fishing and vessel operation.



7. Instructor's Teaching Arrangement

The purpose of this course is to give the student a background in basic physical principles and their application to the marine and fishing industries. The topics covered are designed to provide the basic knowledge required for entry into the applied professional courses forming the second year of the curriculum.

Three 90-minute sessions are scheduled each week. The first part of each session is devoted to a review of problems assigned for student home preparation, and this is followed by a presentation of new material which forms the principal activity of each class meeting, together with the application of the newly introduced theory to basic physical problems and examples found in fishing and vessel operation. Students are required to prepare home assignments for each lecture, and three 1-hour tests are scheduled at convenient points during the course.

8. Method of Grading

Tests	50%
Home assignments	10%
Final examination	40%

FIS 118 - INTRODUCTION TO COMMERCIAL FISHERIES

1. Credits: 4 Lecture hours: 4

Instructor: Meade, Sainsbury

2. Description

Commercial fisheries of the world, the United States, and New England, including fishing grounds, resources, catch statistics, and legislation. Introduction to fisheries biology with emphasis on the natural history of important commercial species and the food chain. Effect of fishing pressure and introduction to the management of fishery resources. Utilization and principal catching methods for the various important commercial species, including vessels and gear.

3. Subject Outline

This course consists of two separate parts, one dealing with biological considerations of commercial fisheries, the other with commercial fishing methods, vessels and gear.

Part A - Biological Considerations

a. Introduction

Fish, environment, and man

The aquatic environment - physical properties

The aquatic environment - chemical properties

Circulation and currents

b. The food chain and commercial species

Identification, nomenclature, and classification of fish

The Decapoda: shrimp, crabs, lobster

Molluscan shellfish

The family Clupeidae

The genus Brevoortia

The family Engraulidae

The family Salmonidae

The family Gadidae

The family Scombridae

The family Pleuronectiformes

c. Fisheries science

Basic ecology

Aquaculture science

Behavior of exploited populations

Fishery resource management

Part B - Commercial Fishing Methods

a. Introduction

Classification of fish for harvesting

Principal types of fishing gear

Choice of fishing method and gear

- b. Towed or dragged gear
  - Bottom otter trawling
  - Bottom pair trawling
  - Multi-rig bottom trawling
  - Midwater trawling, single and pair
  - Dredging
- c. Encircling gear
  - Purse seining
  - Seine netting
- d. Static gear
  - Gillnets and setnets, traps
  - Longlining
  - Pots
- e. Other mobile gear
  - Trolling
  - Harpooning
  - Pole and line

4. Lecture Outlines

Two hours of lectures each week are devoted to Part A, Biological Considerations, and two hours to Part B, Commercial Fishing Methods.

Part A - Biological Considerations

Week 1 - Fish, the environment, and man. The aquatic environment: elements of hydrology, geography of the oceans, bathymetric features, bottom sediments and physical properties of water.

Week 2 - The aquatic environment: chemical properties of sea water, oxygen, nitrogen, carbon dioxide, salinity, nutrient elements, photosynthesis. Circulation and currents: causes of currents, waves, measurement of currents, circulation in lakes, estuaries, and oceanic surface and subsurface currents, including their relationship to the world's major fisheries.

Week 3 - Identification, nomenclature and classification of fish, phytoplankton, zooplankton and algae. The Decapoda, Shrimp - a rapid survey of the family Penaeidae with emphasis on Penaeus setiferus, P. aztecus and P. duorarum. Cold water shrimp of the family Pandalidae to be covered with emphasis on Pandalus borealis. Survey of shrimp resources of Central and South America as well as other foreign waters.

Week 4 - The Decapoda, Crabs - commercial species of crabs of the Atlantic and Pacific coasts, including crabs of the genera Callinectes, Cancer, Paralithodes, Geryon and Chionoectes. The Decapoda, Lobsters - a review of the biology, distribution, abundance and economic importance of the commercial species to include members of the families Homaridae and Palinuridae.

Week 5 - Molluscan shellfish - a brief review of the oyster, clam, scallop, and abalone fisheries of the U.S. Short summary of the shellfish resources and industries of the world. The family Clupeidae - a review of the biology, distribution, abundance and economic importance of the genera Clupea, Sardinops, Alosa and Sardinella.

Week 6 - The genus Brevoortia - The species patronus, tyrannus, gunterii and smithii: their biology, migrations spawning, distribution, abundance and economic significance in the U.S. fishery. The family Engraulidae - emphasis on the Peruvian anchovetta, Engraulis ringens. Anchovy resources of the U.S., South Africa, Japan and other countries.

Week 7 - The family Salmonidae - salmon and trout fisheries of the world with emphasis on the Pacific salmonids of the genus Oncorhynchus. The Atlantic salmon, Salmo salar, and its decline as a major resource. The family Gadidae - review of codlike fishes, their distribution, abundance, catches and economic value to countries involved in the various fisheries. Northern Hemisphere resources: cod, haddock, hakes, pollack; Southern Hemisphere hake resources.

Week 8 - The family Scombridae - mackerel and tuna as a U.S. fishery and world resource. The family Pleuronectiformes - the halibut fisheries of the North Atlantic and North Pacific: Greenland halibut, Canadian plaice, summer flounder, yellowtail flounder, and winter flounder related to their respective fisheries and importance in the fresh fish market.

Week 9 - Basic Ecology - factors relating to single species populations, communities and ecosystems, material and energy flow, production and yield. Aquaculture science - finfish and shellfish aquaculture on a worldwide basis. Warm water and cold water aquaculture in the U.S. Problems of systems management, biology, nutrition, disease, and regulations. The future for aquaculture.

Week 10 - Behavior of exploited populations; effects of fishing pressure, stocks and migrations, collection of information, gear selectivity, recruitment, stock size and growth.

Week 11 - Fishery resource management - functions of fishery resource agencies, origins of public policy, methods of management, economic problems of fishery management, conflict with uses of water, international laws, commissions and agreements.

Week 12 - Specific fisheries problems and discussion of future for world fisheries.

Part B - Commercial Fishing Methods

Week 1 - An introduction to the business of fishing.

Choice of fishing gear and method: species being fished, individual value, fishing area, economics. Principal types and classification of gear. Use of single method and combination vessels.

Week 2 - The bottom otter trawl - the net, otter boards, construction and rigging. Side trawling - arrangement of gear and vessel, towing arrangement, hauling and setting the net, equipment required.

Week 3 - Stern trawling using quarter ropes - arrangement of vessel and gear, fishing operation, equipment. Stern trawling using a net drum - gear arrangement of vessel, fishing operation. Stern ramp trawling - arrangement of gear and vessels of various sizes and rigs.

Week 4 - Stern ramp trawling - the fishing operation. Stern trawling using various combinations of ramp, drum and other handling arrangements. Advantages and disadvantages of stern trawling using various rigs. Bottom pair trawling and its applications.

Week 5 - Multi-rig trawling - arrangement of gear, vessels and fishing operation for double rig otter trawls and try net, with particular reference to shrimp fisheries; vessels, gear and operation for double rig vessels using beam trawls for bottom fish; safety precautions.

Week 6 - Midwater trawling - arrangement of gear and vessels for single vessel working and for midwater pair trawling. Net instrumentation, and control of net during fishing operation. Application of single and two-vessel operations.

Week 7 - Dredging - gear types, vessel arrangements and fishing operations for inshore and offshore dredging with particular reference to the clam and scallop fisheries. The purse seine - net types, construction and rigging.

Week 8 - Purse seining - gear, vessel arrangements and operation for the Western one boat, drum seining, and Scandinavian one boat systems.

Week 9 - Purse seining - method, vessel arrangement, equipment and operation for the twin purse boat system as used in the menhaden fisheries, the lampara seine, and ring netting.

Week 10 - Seine netting - principle of method, vessel arrangement and fishing operation for fly dragging, anchor dragging and tow dragging.

Week 11 - Static fishing methods - arrangement of gear types, vessels and operation for the use of gillnets, driftnets, traps, longlines, and inshore potting.

Week 12 - Offshore potting - gear, vessels and operation for working pots offshore, with particular reference to the lobster and crab fisheries. Gear

and vessel operation for trolling, harpooning and pole fishing.

5. Textbooks

Part A - Introduction to the Fishery Sciences by William F. Royce, pub. by Academic Press Inc. 1972

Part B - Commercial Fishing Methods by John C. Sainsbury, pub. by Fishing News (Books) Ltd., London. 1972

6. Handouts

Part A - Mimeographed notes prepared by instructor.

7. References and Additional Reading Material

Part A - Oceanography by Jerome Williams  
The Ecology of Fishes by G. V. Nibelsky  
Industrial Fishery Technology ed. by FAO  
Lobsters, Crabs and Crayfish by R. D.

O'Farrell

Fishes of the Gulf of Maine by Bigelow & Schroeder

FAO Fisheries Statistics

Fishery Leaflet No. 550, NMFS

Part B - Fishing Boats of the World, Vols. I, II, III, ed. by J. O. Traung

Fishing Gear of the World, Vols. I, II, III, ed. by H. Krisjonssen

Proceedings of Conference on Mechanisation and Automation in the Fishing Industry, Canadian Fisheries Report No. 15.

Proceedings of Canadian Atlantic Offshore Fishing Vessel Conference, Canadian Fisheries Report No. 7.

Deep Sea Trawling and Wing Trawling by John Garner, Fishing News (Books), London

Modern Deep Sea Trawling Gear by John Garner, Fishing News (Books), London

The Seine Net, Its Origin, Evolution and Use by D. Thomson, Fishing News (Books), London

8. Visual Aids and Other Materials

a. Series of slides showing sequences of setting and hauling for principal fishing operations.

b. Films, available from URI Film Production Center, 16mm, sound.

The Hunt for Fish

Stern Drum Trawling

Stern Trawling with Quarter Ropes

Purse Seining

c. Film produced by New Bedford Seafood Council, 16mm, sound. Pearl of the Atlantic (scallop fishing)

- d. Film produced by Fisheries and Marine Technology Dept., URI, 16mm silent. Dredging for Quahaugs
- e. Films produced by Marine Construction and Design Co., Seattle, 16 mm, silent.
  - King Crab Fishing in the Kodiak, AK. Area
  - King Crab Fishing in the Dutch Harbor, AK. Area
  - Scottish Seining with MARCO Power Block
  - Anchovy Fishing in Northern Chile
  - Tuna Net Trial
  - Gillnet Fishing Bristol Bay, AK

9. Instructors' Teaching Arrangement

Teaching work is divided into two equal complementary but separate sequences of lectures taught by separate instructors. Each part uses two lecture sessions each week.

In both parts, students are given reading assignments one session in advance and are expected to familiarize themselves with the assigned topics. Class time is used to emphasize important aspects and for open class discussion and expansion of the text contents. For the section on fishing methods, films showing the fishing procedures, vessels and gear are used to provide descriptive action which is coupled with slide presentations of the important factors involved in each case.

Part A concentrates on providing a good applied biological background to commercial fisheries and emphasizes the student's learning and absorption of this knowledge. In Part B, emphasis is placed on assisting the student to learn and describe operational sequences through clear descriptive writing and sketching.

10. Method of Grading

The two parts are considered separately for grading purposes, each forming one half of the total grade average. A single final examination is divided into two parts of equal importance. Throughout the semester, tests are arranged following completion of each section of the subject outline together with midterm examinations.

Tests	60%
Midterm and final exams	40%

FIS 121 - FISHING GEAR I

1. Credits: 3 Lecture hours: 2 Laboratory hours: 3

Instructor: Hillier

2. Description

Detailed study of bottom and midwater trawls and other dragging gear. Emphasis on the construction, repair, and use of different rigs and net designs, including the seine net.

3. Subject Outline

a. The Yankee net

Parts  
Twine  
Construction

b. Sweep ropes

Rollers  
Rubber cookies  
Rounded wire  
Combination chain

c. Net sections

Top wings  
Bottom wings  
Square  
Bellies  
Cod end and chafing gear

d. Working lines

Bull rope  
Choker  
Quarter ropes  
Splitting strap

e. Hanging the net

Hanging coefficients  
Headrope  
Footrope  
Gore rope  
Door end rope

f. Floats

Types and materials  
Number  
Attachments

g. Main warps

Construction  
Marking  
Maintenance  
Connection  
Deck bollards  
Fairleads  
Hanging bollards  
Hook-up blocks



- h. Legs and ground cables
  - Construction
  - Maintenance
  - Connections
  - Independent wire (idler)
  - Eye/stopper arrangement
- i. Otter boards
  - Types and use
  - Construction
  - Balancing
  - Connections and rigging
- j. Twine tapers
  - Body cut
  - Jib cut
  - Extension cut
  - Wing cuts
  - Use of formulae
- k. Net types
  - Yankee 35
  - Yankee 36
  - Yankee 41
  - Yankee 41a
  - Variations on Yankee design
  - Wing trawls
  - High opening trawls
  - Midwater trawl
  - Seine net

4. Lecture Outlines

- Week 1 - Net dimensions, parts of twine, how they are shaped, and dimensions of each section. Use of double and single twine. Fitting together of sections.
- Week 2 - One piece and three-piece headlines, materials and construction. Types, materials and construction methods for floats.
- Week 3 - Construction, advantages and disadvantages of various types of footrope: roller, cookies, rounded and combination sweeps. Types of bottom for which each is suited.
- Week 4 - Dimensions, shape, tapers, cutting and knitting, dogs ears, selvedging of the bottom wings.
- Week 5 - The square, bellies - dimensions, shape, tapers, cutting, and knitting, double meshing, selvedging, hanging coefficients, connections.
- Week 6 - Construction of the net - lacing, goring, hanging, sewing, attachment to the mouth frame. Knitting cod end and its attachment. Types, manufacture and attachment of chafing gears.
- Week 7 - Construction, attachment and working of quarter ropes, ball rope, chokers, splitting straps, cod end rings and rope.

Week 8 - The main warps - size and type of wire, splicing, marking, maintenance, warp depth ratio. On-board run and operation of warps, deck bollards, fairleads, hanging bollards, hook-up blocks.

Week 9 - Construction and operation, maintenance, connections for legs and ground cables. Arrangement of idler for stopper/eye and for drum or ramp operation.

Week 10 - Types and uses of otter boards - construction, balancing, brackets, backstraps and connections.

Week 11 - Tapering twine; the use of taper formulae to obtain tapers using the body, jib, extension and wing cuts.

Week 12 - Dimensions, twine and rigging of the various nets in the Yankee series and variations in design to provide high opening nets.

Week 13 - Introduction to the design, construction and rigging of midwater trawls and the seine net.

5. Laboratory Projects

Week 1 - Straight twine mending - revision of mending a hole and patching a hole. Practice in twine mending.

Week 2 - Dogs ears - knitting, mending, back scuttling of dogs ears. Various methods of joining wings using dogs ears.

Week 3 - Cutting net sections - tapering and cutting net sections from the web, both full size, and scaled down for use in construction of model nets.

Week 4 - Preparation of sections - knitting on selvages, double meshing, dogs ears and other work to prepare the net sections for joining.

Week 5 - Construction of the net - sewing and lacing together sections and the halves of a net.

Week 6 - Hanging the net - attachment to the head-rope and hanging line using hanging coefficients; attachment of gore line. Attachment of floats.

Week 7 - The cod end - knitting the cod end, attachment of rings and cod end rope, attachment of splitting strap.

Week 8 - Straight bars - the mending, back scuttling and joining of straight bars.

Week 9 - Sweep ropes - construction of various types of sweep rope including the use of rollers, spacers, wire, chain, rounding; the various ways of attaching sweep ropes to the net.

Week 10 --Working lines - construction and attachment of the working lines, including quarter ropes, bull rope and choker.

Weeks 11,12,13 - Model net - the complete construction of a scale model net using the methods and techniques of full-scale size twine to produce a replica of a standard Yankee bottom trawl.

6. Textbook  
Deep Sea Trawling and Wing Trawling by John Garner, pub. by Fishing News (Books) Ltd., London.
7. Handouts  
Mimeographed lecture notes for each week
8. References and Additional Reading Material
  - a. Modern Fishing Gear of the World, Vols. I, II, III, ed. by H. Krisjonssen
  - b. Various booklets published by Bridport Gundry Ltd., Bridport, England
  - c. Modern Deep Sea Trawling Gear by John Garner, pub. by Fishing News (Books) Ltd., London
  - d. How to Make and Set Nets by John Garner, pub. by Fishing News (Books) Ltd., London
  - e. The Seine Net, Its Origin, Evolution and Use by David B. Thomson, pub. by Fishing News (Books) Ltd., London
  - f. Various Fisheries leaflets pub. by National Marine Fisheries Service, Washington, D.C.
9. Visual Aids and Other Materials
  - a. Net models of principal bottom trawl designs
  - b. Models of principal types of doors
  - c. Models of side and stern trawlers
  - d. Full scale portions of various sweep-rope constructions
  - e. Display of hardware used in net construction and rigging
  - f. Wall display charts of principal net designs
10. Equipment List

Special equipment necessary for this course is given below; not included are items which would normally form part of the laboratory structure.

  - a. Riggers vises and marlin spikes
  - b. End cutters
  - c. Side cutters
  - d. Measuring tapes - 100 ft.
  - e. Rollers and other parts for construction of roller sweeps (may be dismantled and used in succeeding years)
  - f. Sweep wrapping device (powered)
  - g. Gear storage racks and boxes
  - h. Net storage drums and boxes for individual nets
  - i. Portable stanchions and hook-ups for hanging and stretching webbing.
11. Supplies

Special supplies needed either for each student or in total for the course are included.

- a. Tools - wrenches, hammers, cold chisels, twine needles
- b. 200 fathoms 7/16 inch wire (replacement warps)
- c. 200 fathoms 3/8 inch wire (legs)
- d. 100 fathoms 3/8 inch black chain (legs and sweep)
- e. 2 standard lower wings for each student (for working with dogs ears, straight bars, and joining wings) of cheapest obtainable material.
- f. 30 pounds of mending twine for wings (each student)
- g. Approx. 250 pounds of standard mesh nylon web for making full-size nets.
- h. One pound of twine (nylon) for each student to put together the full-size nets
- i. Approx. 150 pounds of 1-, 1-1/2-, and 2-inch nylon web for making model nets
- j. Floats, hardware, etc.
- k. Model size floats, rope, chain, etc., for scale nets

12. Instructor's Teaching Arrangement

Teaching work is divided into two interrelated activities--two 1-hour lecture sessions and one 3-hour laboratory section are arranged each week. In addition, the students are encouraged to make use of the twine laboratory facilities in their spare time and during the evening in order to increase their skills.

Lectures: These are based mainly on mimeographed material distributed by the instructor, as no really satisfactory text is available. The instructor's notes cover modern U.S. and New England practice. The stated text covers practice mainly in Europe, so that these two sources are complementary. Students are expected to prepare for each lecture, using the notes which are distributed in advance, the class time being used to emphasize important points, and extend the subject material to cover the various situations that arise at sea when fishing.

Laboratory: These are arranged to build the student's skill in twine work following the initial activities in FIS 013, Shipboard Work I. Each stage in the preparation and construction of a standard net is covered in sequence, and this is then extended to cover the variations in design and construction techniques found in the U.S. and world wide. At least one full-scale net is built in each course for use with the training vessels, the design depending on the particular need. In addition to the work specified for each laboratory session, students also undertake mending and rigging work with nets used by the training vessels as needed during the course. Each student is expected to produce a model net of

a standard Yankee bottom trawl rigged to an agreed specification, and this is considered an extremely important part of the course. Each student is expected to complete a formal laboratory notebook containing a complete statement of all procedures undertaken during the laboratory sessions, and in a form enabling it to be used as a reference work after completion.

13. Method of Grading

- |  |     |
|--|-----|
| a. A one-hour practical test of twine skills | 25% |
| b. Final examination                         | 25% |
| c. Model net                                 | 20% |
| d. Laboratory/notebook                       | 30% |

FIS 122 - FISHING GEAR II

1. Credits: 3 Lecture Hours: 2 Laboratory Hours: 3

Instructor: Hillier, McCauley

2. Description

Detailed study of the purse seine, gillnet, trap and longline. Emphasis on the construction, repair and use of the various arrangements and designs of each. Brief treatments of other fishing methods.

3. Subject Outline

a. Basic net modifications

Effects of changing mesh size  
Lengthening the net  
Use of extension pieces  
Resistance in small twine  
Power requirement  
Effects of hanging ratio changes

b. Behavior study of herring

Sensitivity to sea and weather conditions  
Effects of light and darkness  
Patterns in fish movements, direction and depth  
Searching procedure  
Reaction to fishing gear  
Locating and catching fish, bottom and midwater  
Positioning the gear

c. Wing trawl designs

"Five Fathom" Engle Trawl  
Two-bridle European wing trawl  
Three-bridle European wing trawl  
Russian 27.1 meter trawl  
Modifications and direction of development

d. Midwater trawling operations

Controlling the gear  
Effects of speed and warp length  
Effects of tide  
Length of bridles  
Trawl door designs  
Twine requirements  
Design trends

e. Midwater trawl designs

Canadian Diamond trawl  
Pelagic Engle net  
Larsen pair trawl  
Cobb Pelagic trawl  
Boris midwater trawl

f. Requirements of a purse seine

Catching requirement  
Effect of length  
Effect of depth

- Effect of twine size and weights
- Effect of hanging ratio
- Causes affecting sinking rate
- Position of the net during pursing operations
- Problems in pursing
- g. Seine designs and methods of handling
  - Single boat menhaden seines
  - Single boat mackerel seines
  - Canadian herring seine
  - Two-boat menhaden seine
  - Salmon purse seines
  - Tuna purse seines
  - Advanced seine design and trends
- h. Gillnet designs and methods of handling
  - Principles of gillnet fishing
  - Drift nets for salmon
  - Bottom nets for cod
  - Encircling gillnets used in Gulf of Mexico

#### 4. Lecture Outlines

Week 1 - Changing the mesh size to catch various species of fish, methods of increasing the headrope height of standard trawls, increasing the digging ability of standard trawl, lengthening procedures to include use and construction of tailpieces and liners. Effects on towing when making the above changes.

Week 2 - Behavior of herring affecting the catching possibilities, such as effects of light, darkness, sea condition, tides, rain or snow, water temperature, fishing effort, and the twine or net itself. Expected patterns of fish movement, fish location, and searching procedure.

Weeks 3,4 - Detailed study of the wing trawl design in use, including effects of hanging, towing bridles, twine size, flotation, weighting, and methods of handling. Review of faults found in use of the gear.

Week 5 - The stability of a net in midwater, problems encountered in controlling depth, accepted fishing procedure, monitoring the position of the midwater trawl, use of headrope transducers, towing speed, and vessel power requirements.

Weeks 6,7,8 - Detailed study of the midwater trawl designs and trends to include hanging, towing arrangement, twine size, weighting, control of each design, and a review of the faults found in the performance of each design.

Week 9 - Design purpose of a seine and the effects of hanging, length-depth ratio, weighting, tension; identification of inefficiency in a seine, controlling fish by design, conditions affecting and methods

of improving sinking rate. Problems of controlling depth during pursing operations, and procedures for clearing fouls and hangs.

Weeks 10,11,12 - Detailed study of the various seine designs, including preferences in hanging, flotation, weighting, twine size and weight, ring spacing, purse line choice, materials, and costs. The use of each seine and behavior of the fish to be caught before and after the set is made.

Week 13 - Gillnet designs and use, handling procedures, fish behavior, materials and costs, economics of a small boat gillnet operation.

5. Laboratory Projects

Weeks 1,2 - Project No. 1. Review of general twine work covered in Fishing Gear I.

Weeks 3,4,5 - Project No. 2. Counting out and measuring examples of full-size wing and midwater trawls.

Weeks 6,7,8 - Project No. 3. Construction of a full-sized wing or midwater trawl.

Weeks 9, 10 - Project No. 4. Counting out and measuring full-size seines and gillnets.

Weeks 11,12,13 - Project No. 5 - Construction of a model of one of the nets discussed in the lecture period. Each student is assigned a different design.

6. Textbooks - none available.

7. Handouts (duplicated material)

- a. Modified plan of 60x80 bottom trawl
- b. Plans of two-bridle wing trawl
- c. Plans of three-bridle wing trawl
- d. Plans of Five Fathom Engle trawl
- e. Plans of Russian 27.1 meter trawl
- f. Plans of No. 5 Canadian Diamond trawl
- g. Plans of 740 mesh Pelagic Engle net
- h. Plans for a 2/3 scale Cobb Pelagic trawl
- i. Plans for model 648 Cobb Pelagic trawl
- j. Plans for Boris midwater trawl
- k. Plans for single-boat menhaden seine
- l. Plans for Atlantic Coast mackerel seine
- m. Plans for Canadian herring seine
- n. Plans for two-boat menhaden purse seine
- o. Plans for Pacific Coast salmon purse seine
- p. Plans for Pacific Coast hybrid tuna seine
- q. Handout explaining hanging percentages
- r. Handout on twine equivalents, strength by twine diameter and mesh size
- s. Twine samples of thread sizes, twisted and braided



8. References and Additional Reading Material
  - a. New England Marine Resource Information Program Booklet entitled, "Two-Boat Midwater Trawling for Herring," by James McLeod, published 1969.
  - b. U.S. Bureau of Commercial Fisheries Gear Research Base, Seattle, Wash. publication entitled, "Purse Seine Revolution in Tuna Fishing," by Richard L. McNeely, reprinted from "Pacific Fisherman," June 1961
  - c. Modern Fishing Gear of the World No. 2, papers and discussions at the second FAO World Fishing Gear Congress, London, 1963. Published by Fishing News (Books) Ltd., Ludgate House, 110 Fleet St., London, England. 1964.
  
9. Visual Aids and Other Materials  
Models of most of the nets and gear discussed.
  
10. Equipment List
  - a. Full-size nets corresponding to those discussed in lecture periods.
  - b. Full-size trawl doors of various designs discussed.
  - c. Working headrope transducer and recorder.
  - d. Hydraulic power block.
  - e. Hydraulic gillnet block.
  - f. Full-size gillnets with buoys, etc.
  
11. Laboratory Layout
  - a. Complete twine loft with storage facilities.
  - b. Adequate floor space for laying out full-size trawls.
  
12. Supplies
  - a. Complete supply of twine sheets of the mesh size and twine diameter to complete all the projects listed.
  - b. Adequate supply of mending and hanging twine needed to complete the projects listed.
  - c. Rope, wire, and combination wire rope necessary for hanging nets to be constructed.
  
13. Instructors' Teaching Arrangement  
Teaching work is divided into two interrelated activities; lecture sessions, with two lectures and one laboratory period of two sections.  
Lecture Procedure: Devoted to the detailed study of design of the gear mentioned previously. An analysis and discussion of the reasons for the particular gear and methods adopted in each case. The theoretical aspects of the gear represent an important segment of the understanding of future gear possibilities.

Laboratory Procedure: The laboratory affords the student an opportunity to see and work with the actual gear that is fished. All the available full-size nets have been worked and the results are a matter of record. The opportunity to build a full-size net and either fish it on the training vessel or loan it out for use by local commercial vessels gives the student a broader feel for the realistic application of the entire course in advanced gear. The model construction allows each student the chance to individually construct a net and includes all the scaling, planning, etc., necessary for a full-size net; at the same time the size makes it possible to see and work with the whole net, which is not possible in the full-size version.

14. Method of Grading
- |                               |     |
|-------------------------------|-----|
| a. Two tests                  | 20% |
| b. Final examination          | 20% |
| c. Laboratory work evaluation | 40% |
| d. Model construction project | 20% |

FIS 131 - SEAMANSHIP

1. Credits: 3    Lecture hours: 2    Laboratory hours: 3

Instructor: Motte, Stout

2. Description

Basic shipboard terminology and orientation. Safety at sea. Characteristics and use of rope and wire, tackles, gear systems, stress factors. Shipboard maintenance. Ship handling. Rules of the Road. Knots, bends, hitches, rope and wire splicing.

3. Subject Outline

a. Terminology and Orientation

Ship layout  
Nautical terminology  
Helm orders  
Lookout procedures  
Division of day at sea

b. Mast and boom rigs

Masts and derricks  
Standing rigging  
Running rigging

c. Lifesaving appliances

U.S. Coast Guard regulations  
Lifebuoys and lifejackets  
Flares  
Lifeboats  
Inflatable liferafts

d. Fire fighting

Cause and prevention of fires  
Fire detection and extinguishing equipment  
Procedures

e. Rope

Natural fiber ropes  
Synthetic fiber ropes  
Wire and combination ropes  
Safe working loads and breaking strengths  
U.S. tackle regulations

f. Gear systems

Shackles  
Blocks  
Purchases  
Use of tackles and combinations  
Stress factors

g. Maintenance

Gear  
Deck equipment  
Hulls

- h. Anchors
  - Types of anchors
  - Anchor and cable arrangement
  - Procedures
- i. Ship handling
  - Rudder and propeller theory
  - Maneuvering of single screw vessels
  - Use of anchors for maneuvering
  - General shipboard procedures
  - Towing procedures
  - Grounding and beaching
  - Distress and rescue operations
  - Ship handling in heavy weather
- j. Rules of the road
  - International rules
  - Inland rules
- k. Practical seamanship
  - Knots, bends, and hitches
  - Whippings, seizings, servings
  - Fiber rope splicing
  - Fiber and wire rope handling, stoppers
  - Bos'n's chair, lashing, shoring
  - Blocks, fairleads, winch heads
  - Purchases
  - Wire rope splicing

4. Lecture Outline

Week 1 - Ship layout--main sections of a ship including general deck arrangement. Nautical terminology--division of the day at sea, general shipboard terminology.

Week 2 - Helm orders and lookout procedures--helm orders for general maneuvering, the point system for target reporting at sea. Mast and boom rigs--standing and running rigging for masts and derricks, shrouds, stays, topping lifts, runners, guys, preventers.

Week 3 - Lifesaving appliances--the Coast Guard regulations for safety on board fishing vessels and small vessels. Coast Guard regulations for life-jackets, lifebuoys, flares, lifeboats and inflatable liferafts.

Week 4 - Firefighting--causes and prevention of fires on board ship; how fire starts and spreads on board; hold and engine room fires; classes of fire extinguishers, smoke helmets and breathing apparatus, fixed detection and extinguishing systems.

Week 5 - Natural fiber ropes--construction and use of twisted and braided manila, sisal, hemp, and coir ropes--advantages and disadvantages of the most common synthetic fiber ropes. Comparison with natural fiber ropes.

Week 6 - Wire and combination ropes--construction and use of wire ropes, treatment and handling of wire ropes. Safe working loads and breaking strengths--safety factors, safe working loads and breaking strengths as applied to shipboard equipment.

Week 7 - United States tackle regulations--general shipboard safety regulations at sea and in port. Blocks--component parts and construction of various types of blocks.

Week 8 - Purchases--mechanical advantages and general use of all common purchases from the single whip tackle to the threefold purchase. Uses of tackles and combinations--selection of ropes for various tackles and choice of tackle to fit various jobs.

Week 9 - Stress factors in derrick and gear systems--parallelogram of forces within derrick and gear systems to determine stress factors. General shipboard maintenance--preservation of rope, wire, and general deck equipment, introduction to shipboard maintenance.

Week 10 - Anchors--parts of stockless bower and stream or kedge anchors, general anchor and cable arrangement. Shackles--component parts of a shackle. use of various types of shackle.

Week 11 - Rudder and propeller theory--rudder effects and propeller effects on maneuverability, effect of draft, trim, list, shallows, banks, wind and tide on maneuverability. General maneuvering of single screw ships--procedures, turning short around, docking, undocking making fast and slipping a buoy, using helm, engines, anchors and ropes.

Week 12 - Use of anchors for maneuvering--running and standing moors, procedure for dragging anchor, use of cables in heavy weather, tidal regions, and to form a lee. General shipboard procedure--general procedure, proceeding to sea, keeping a watch at sea, keeping an anchor watch.

Week 13 - Towing procedures--use of equipment on board for short tows and long ocean tows in good and bad weather. Grounding and beaching procedures--procedure if necessary to beach a vessel, also measures for refloating a grounded vessel.

Week 14 - Distress and rescue operations--man overboard procedure and action in time of distress. Procedure from sighting distress signals to rendering assistance. Ship handling in heavy weather--rigging of jury rudder and steering gear, heaving-to in a violent sea, use of oil and "leg of mutton" sail.

Note: In addition to the above, approximately one-tenth of each weekly classtime is devoted to coverage of "Rules of the Road."

5. Laboratory Projects

Week 1 - Wire rope splicing--the Roebling eye splice.

Week 2 - Knots, bends and hitches--simple and intricate knots, bends and hitches.

Week 3 - Whippings, seizings, servings--simple and intricate work with twine, marlin and various equipment.

Week 4 - Fiber rope splicing--back, eye, short and long splices; dogging, tapering.

Week 5 - Fiber and wire rope handling, stoppers--breaking out and stowage, deck handling, chain and rope stoppers.

Week 6 - Bos'n's chair, lashing, shoring--man aloft procedures, Spanish windlass, securing gear on deck and below.

Week 7 - Blocks, fairleads, winch heads--block usage, rope abuse, safety considerations.

Week 8 - Purchases--reaving and application of common tackles.

Weeks 9,10 - Wire rope splicing--fisherman's splice, locking splice, cut splice.

Weeks 11,12,13 - Practice and review exercises on work of previous laboratory projects.

Note: In addition to the above, some time is devoted to the practical application of Rules of the Road procedures during each laboratory session.

6. Textbooks

a. Rope Knowledge for Riggers, pub. by Columbian Rope.

b. The Collision Rules with Questions and Answers, by J. R. Knott, pub. by Kandy Publications Ltd., England.

c. The New Boatman's Manual, 3rd ed., by C. D. Lane, pub. by W. W. Norton & Co., New York.

d. Light Recognition, by D. A. Moore, pub. by Kandy Publications Ltd., England.

e. Useful Knots and How to Tie Them, pub. by Plymouth Cordage.

f. Rules of the Road - International - Inland, CG-169, U.S. Coast Guard.

7. Handouts - Mimeographed material is provided as follows:

a. Profile and vessel plan

b. Mariners compass and steering by points instruction

c. Signals, code flags

d. Knot effectiveness and splice efficiencies

e. Weekly take-home assignments in Rules of the Road

f. Exercises on safe working loads, and tackles and purchases

8. Visual Aids and Other Materials

- a. Display of the various knots, bends, hitches and fancy ropework
- b. Display of firefighting equipment
- c. Display and chart instructions for lifesaving equipment
- d. Display and operating instructions for distress flares, etc.
- e. Display of the parts and maintenance of blocks
- f. Display of wire rope splicing
- g. Models of various fishing vessel types
- h. Sets of slides for Rules of the Road
- i. Rules of the Road demonstration model kit
- j. Films produced by Film Production Center, University of Rhode Island: Maintenance of Steel Hulls and Maintenance of Wooden Hulls
- k. Film Survival, C. J. Hendy Co.

9. Field Trip

At a convenient point during the course, a field trip is arranged to the firefighting school at the Newport Naval Base, where a display of firefighting techniques is provided.

10. Equipment

- a. One 50 ft. measuring tape, one yardstick
- b. Distress equipment--flaregun with flares, hand-held rocket parachute flare, hand-held daytime flare, hand-held nighttime flare, distress banner, rocket line apparatus
- c. Hand-cranked grinding wheel
- d. Riggers vise
- e. Cutters--heavy duty bolt cutters, two small wire cutters
- f. Hand tools--two 21 lb. mauls, two adjustable wrenches, two 10 in. pliers, two 10 in. linesman's pliers, two 8 in. needle-nose pliers, cold chisels
- g. Full-scale working rig of mast and derrick with winches
- h. Three bos'n's chairs
- i. Snatch blocks--6 in. fiber rope--one swivel hook--one swivel shackle
- j. Snatch blocks--6 in. wire rope--one swivel hook--one swivel shackle
- k. Two wire rope reel trestles (or roller pads)
- l. 3/8 in. open barrel turnbuckles--two clevis pin--two hook--two ring
- m. 1/2 in. pelican hook
- n. One set of the following for each six students in a group: 12 - 6 in. reverse hook fiber rope blocks (2 single sheave, 2 double sheave, 2 -

- 3 sheave, 2 - 4 sheave, 2 - 5 sheave, 2 - 6 sheave)
- 2 - serving mallets
- 1 - serving palm
- o. One set of the following for each student in a group:
  - 1 - fid
  - 1 - marlin spike
  - 1 - mechanic's or pipe vise
- p. Four ft. length of work bench for each student in a group, containing one of the vises with a tricing hook arranged above each vise.
- q. Three ft. length, for each student in a group, of horizontal pipe, or equivalent, at heights of 40 in. and 100 in. above floor
- r. Numerous attachments, each with a safe working load of one ton
- s. Minimum of 36 sq. ft. of laboratory floor space for each student in a group

11. Supplies

- a. For each student:
  - One twine knife
  - Wire rope: 20 ft. of 5/8 in., 25 ft. of 1/2 in., 30 ft. of 3/8 in.
  - Nylon rope: 10 ft. of 1-1/4 in. diameter
  - Polypropylene rope: 20 ft. of 1/2 in. diameter
  - Poly-dac rope: 30 ft. of 1/2 in. diameter
  - Sisal rope: 50 ft. of 1/2 in. diameter, 50 ft. of 1 in. diameter
  - Assorted fiber and wire thimbles
  - Wire rope clips
  - 1/2 in. reverse hook
  - 3/8 in. screw pin shackle
- b. For each six students in a group:
  - 1/2 lb. seizing wire
  - 3 lbs. marline
  - 1-1/2 lbs. 6-thread nylon twine
  - 6 lbs. 18-thread cotton twine
  - 6 lbs. manila twine
  - 3 lbs. hand cleaner
  - 1/2 lb. general purpose grease
  - 1 qt. general purpose oil
  - 18 ft. 1/4 in. galvanized forged steel open-link chain

12. Instructors' Teaching Arrangement

Teaching work is divided into two interrelated activities, two 1-hour lecture sessions, and one 3-hour laboratory session being scheduled each week. For the laboratory sessions, students are divided into relatively small groups, with a useful maximum



per group being about ten students. One field trip is included during the course.

Lecture sessions are devoted to presentation and discussion of the course material, approximately one-tenth of the time being spent each week on Rules of the Road. Reading and home assignments are used and students are expected to undertake the necessary preparation for each lecture, so that the session may be spent on amplification and supplementation of the text material.

In the laboratory sessions, the techniques, materials and apparatus of practical seamanship are explained and used in practice of the subject, demonstration, and criticism being provided as appropriate. Continuing observance of safe practices is emphasized. Time is drawn from these sessions to study practical Rules of the Road problems, as convenient.

Examinations, both written and practical, are held at mid-semester and at the end of the course.

13.	<u>Method of Grading</u>	
	Mid-semester written exam	20%
	Mid-semester practical exam	10%
	Final written exam	30%
	Rules of the Road exam	10%
	Final practical exam	20%
	Home assignments	10%

FIS 135 - FISHERIES METEOROLOGY

1. Credits: 2 Lecture hours: 2  
Instructor: Motte
2. Description  
Basic practical meteorology and weather forecasting for the mariner. The atmosphere, heat budget of the earth, hydrometeors. Fundamental pressure systems, air masses, formation of fronts and associated weather. Precursory signs, tracks and vessel conduct for tropical revolving storms. Ice, icebergs and icing-up conditions. World Meteorological Organization, coding and decoding of weather reports.
3. Subject Outline
  - a. The atmosphere
    - Characteristics of atmospheric layers
    - Heat budget of the earth
    - Critical balances of nature
    - Evolution theories
    - Water vapor, heat transfer and change of state
  - b. World pressure and wind
    - Atmospheric stability and instability
    - Adiabatic lapse rates
    - Circulation of the oceans and atmosphere
    - Component causes of wind
    - Beaufort wind scale
  - c. Precipitation
    - Cloud classification and formation
    - Fog formation and types
    - Classification and formation of hydrometeors
  - d. Air masses
    - Fundamental pressure systems and air masses
    - Fronts and associated weather
    - Frontal development and theories
  - e. Wind
    - Converging and diverging air
    - Descending and ascending air
    - Local winds and thunderstorms
  - f. Tropical revolving storms
    - Precursory signs of hurricanes
    - Terminology and local names for tropical revolving storms
    - Vessel conduct in vicinity of tropical revolving storms
    - Theories on formation and track
  - g. Ice
    - Ice state classification
    - Iceberg formation and path
    - Icing-up conditions

h. Waves

Shallow water and deep water waves  
Tides, seiches and tidal waves

i. Forecasting

The World Meteorological Organization  
The reporting fleet  
Basic coding and decoding of weather conditions  
Reading a weather map  
Meteorological instruments and recorders  
Analysis and prognosis

4. Lecture Outlines

Week 1 - Characteristics of the atmosphere, the troposphere, tropopause, stratosphere, ionosphere, critical balances of heat and water within the atmosphere. Consideration of the basic theories of evolution, ice ages, heat transfer, temperature, evaporation and condensation. Water vapor, hygroscopic nuclei, long and short wave radiation, adiabatic heating and cooling.

Week 2 - Seasonal changes over continents and oceans. Formation of the principal high and low pressure areas of the world. Prevailing winds of the world in January and July. Component causes of wind, geostrophic, cyclostrophic gradient and frictional components. The Beaufort wind scale.

Week 3 - The principal surface currents of the world, pressure gradients in the ocean. Motion of deep and bottom waters, salinity, temperature and density. Ocean to atmosphere balance. Effects of ocean circulation on weather.

Week 4 - Cloud types and associated weather. Formation of cloud due to convection, orographic lifting at fronts, and by turbulence. Classification and subclassification of clouds.

Week 5 - Advection and radiation fog, Arctic sea smoke and frontal fog. Positioning of lookouts for different types of fog. International regulations for preventing collision at sea, Rule 16 and annex. Formation and classification of hydrometeors, supercooled water droplets. Heat energy transfer.

Week 6 - Continental and maritime air masses and the polar front. Seasonal migration of air masses, specific heat values. The seven fundamental types of isobaric formations.

Week 7 - Bjerknes theory of frontal formation. Wave patterns and families of depressions. Secondary and primary lows, dumbbell depressions and bent back fronts.

Week 8 - Warm, cold and occluded fronts. Frontal formation and decay associated with cloud and precipitation. Buys-Ballots law, rotation and translation. Frontolysis and frontogenesis.

Week 9 - Component parts of wind. Pressure gradients and cyclostrophic effect, Coriolis force and friction. Upper air patterns, converging and diverging air, descending air, and the level of nondivergence.

Week 10 - Local winds. Land and sea breezes and the monsoons. Annabatic and Katabaric winds, the Fohn wind. Theories on the life cycle of thunderstorms, tornadoes and waterspouts.

Week 11 - Study of tropical revolving storms, statistical analysis of paths, intensity and behavior. Precursory signs of approaching hurricanes, regions and seasons expected, and action to be taken by vessels in the vicinity. Comparison of tropical revolving storm and an extra tropical depression. Sea states, deep and shallow water waves.

Week 12 - World Meteorological Organization classification of ice conditions. Navigation in ice regions and iceberg zones. Life cycle of Greenland icebergs and their penetration limits in the Atlantic.

Week 13 - History and function of the World Meteorological Organization and operation of the reporting fleet. Basic coding and decoding of weather conditions. The recording instruments, air and sea thermometers and thermographs, barometers and barographs, anemometers and radio sondes.

Week 14 - Interpretation of the weather map. Plotting a weather analysis. Weather forecasting methods. An introduction to upper air forecasting.

5. Textbooks

- a. Meteorology, by W. L. Donn, pub. McGraw Hill.
- b. Meteorology for B.O.T. Examinations, by Kemp and Young, pub. by Kandy Publications, England.

6. Handouts

- a. Most recent weather maps available
- b. Xerox copies of relevant pages from Meteorology for Fishermen and Boat Operators, to be published by Commercial Fisheries Publications, England.

7. References and Additional Reading Material

- a. Ships Code and Decode Book Met. 0.509, H.M.S.O.
- b. American Practical Navigator, by Bowditch (Meteorology section) U.S. Navy H.O. Pub. No. 9.
- c. The Oceans, by Sverdrup, pub. by Prentice Hall.
- d. Meteorology for Mariners, H.M.S.O.

8. Visual Aids and Other Materials

- a. Transparencies showing sectional atmosphere, Bjerknes theory, frontal cross section, cloud types.
- b. Various weather analysis and prognostic charts.

9. Equipment

Meteorological instruments as for a selected weather ship, to include:

- a. Mercurial and aneroid barometers
- b. Hygrometer
- c. Max. and min. thermometers
- d. Barograph
- e. Thermograph
- f. Anemometer
- g. Facsimile recorder

10. Supplies

- a. Weather chart blanks
- b. Latest chart recordings
- c. Selected weather ship's meteorological log book

11. Instructor's Teaching Arrangement

One double lecture session is held each week; every effort is made to interest students in the day-to-day weather, how and why it develops and to introduce the various more modern theories of meteorology, the object being to develop the continuous weather consciousness, which is the mark of a good seaman.

The first ten weeks provide a good basic theoretical grounding in a purely physical and nonmathematical approach. The final four weeks enter into forecasting and the dynamics of weather as it affects a seaman. Radio forecasts and weather prognoses are examined and analyzed from a seaman's viewpoint. A weather map is constructed from given data and a forecast is made from the map. Daily analysis and prognostic charts are compared and reviewed. Simple coding and decoding is undertaken.

Ten papers are required from students, covering various relevant topics, as particular sections of the course are completed.

12. Method of Grading

Term papers 100%

FIS 141 - MARINE ENGINEERING TECHNOLOGY I

1. Credits: 4    Lecture hours: 3    Laboratory hours: 3

Instructor: McCauley, Wing

2. Description

Diesel engine operation, maintenance, testing, timing and overhaul. Basic principles of diesel designs in common use, including fuel systems, combustion chambers, piston and liner assemblies, camshafts and crankshafts, cooling systems, and lubrication systems.

3. Subject Outline

a. Introduction

Engine fundamentals  
Engine testing  
Engine instrumentation

b. Fuel system

Fuels and combustion  
Combustion chamber designs  
Fuel ignition systems  
Injection nozzles  
Governors

c. Engine structure

Frames  
Cylinders and liners  
Pistons and rings  
Connecting rods and piston pins  
Crankshafts and flywheels  
Bearings  
Valves, gears and cylinder heads

d. Engine systems

Air  
Lubrication  
Cooling  
Exhaust  
Starting

e. Engine drives

Types  
Construction

f. Engine installations

Mounting  
Protective devices  
Trouble shooting

4. Lecture Outlines

Week 1 - The diesel engine, brief history of development, engine cycles, comparisons, general principles. Engineering fundamentals, basic engineering data applied to solution of common problems of design, installation and operation of diesel engines.

Week 2 - Engine testing and instrumentation, how engines are tested, indicated and brake horsepower, efficiency, fuel consumption calculations, pressure, temperature and speed measurements, general testing methods. Fuels, combustion and types of engine fuels, fuel specifications, characteristics and their effects on engine, costs.

Week 3 - Combustion, the chemistry of combustion, factors affecting combustion, knock, smoke, exhaust gas composition. Engine performance, analysis of engine cycle efficiencies, engine ratings, altitude, temperature corrections, heat balance, power costs. Combustion chamber designs, types in common use, principles and performance features, turbulent and quiescent chambers, swirl and squish.

Week 4 - Fuel injection systems, functions and requirements, common-rail, individual-plunger and distributor type systems, precombustion chambers, delivery valves, timing control, fuel quantity requirements. Fuel injection pumps, operating principles.

Week 5 - Frames, cylinders and liners, engine structures, bases, frames, cylinders, crankcase explosions, liner types and construction, servicing and reclaiming liners.

Week 6 - Pistons and rings, piston types, structure, clearances, piston temperatures and control methods, ring types and functions, ring clearances, maintenance. Connecting rods and piston pins, connecting rod designs, loads on rods, alignment, piston pins and bearings, cap bolts and tensioning.

Week 7 - Crankshafts and flywheels, crankshaft arrangement, balancing, crankshaft design, materials, alignment, torsional vibration and dampers, flywheel design, materials. Bearings, bearing loads and polar diagrams, main and connecting rod bearing types and design, bearing materials, characteristics, requirements, clearances, break-in, camshaft bearings.

Week 8 - Valves, valve gears and cylinder heads, cylinder head types, design features, valve inserts and cages, valve designs, materials, temperatures, problems, camshafts and drives, valve actuating gear.

Week 9 - Air systems, engine air requirements, piping layouts, air silencers and cleaners, pre- and after-cooling, expansion cooling. Supercharging, positive-displacement and centrifugal blowers, mechanical and turbine drive, turbochargers, manifolding, supercharging control, performance, heat balance, two cycle turbocharging. Fuel handling, purchase, methods of handling and storage, gauging, piping systems, transfer pumps, filtration and centrifugal cleaning, heavy fuel oil systems.

Week 10 - Lubrication, oil refining, oil characteristics and their affects on the engine, consumption, additives, service classifications, used oil analysis, oil change intervals. Lubrication systems, methods of engine lubrication, oil pumps, types capacities, location, oil coolers, types, capacities, location, system layout and piping, filtration and centrifugal purification, reclaimers, mechanical lubricators.

Week 11 - Cooling systems, cooling requirements and calculations, components and controls, water conditioning, air cooling of engines. Exhaust systems, system design factors, piping layouts, silencers, spark arresters and other system components, waste heat recovery

Week 12 - Starting systems, protective devices and automatic controls, air starting systems, tanks, piping, compressors, gear drive starters, electric, air, hydraulic, aids for low temperature starting, alarm and shutdown devices, automatic operation controls. Speed governors, governing principles and speed regulation requirements, governor types, mechanical, hydraulic, electric, pneumatic, performance characteristics and application, governing turbo-charged engines.

Week 13 - Marine engine drives, flexible couplings, friction clutches, electro magnetic clutches, hydraulic couplings and torque converters, chain drives, reverse and reduction gears, direct reversing engines, controllable pitch propellers. Preventive maintenance and trouble shooting, periodic inspection, preventive maintenance programs, operating records and their uses, methods of trouble shooting. Foundations and engine installations, types of foundations, vibration in foundations, foundation design and form work, engine installations and alignment.

#### 5. Laboratory Projects

Week 1 - Introduction and tour of laboratory, general discussion of different engine types, use and care of tools, safety procedures.

Week 2 - Working of two and four cycle engines, operational cycles. Principal features and start-up of various types and models of engines. Carry out tests for compression and fuel pressure on GM diesel. Examine GM blower assembly.

Week 3 - Testing equipment, principles and use of gauges for measurement of exhaust back pressure, crank case pressure, air box or manifold pressure, air inlet vacuum, fuel pressure, compression, on various engine models.



Week 4 - Combustion chambers, use of cutaway engines to demonstrate methods and types of combustion chamber for various models. Removal and correct installation of cylinder heads.

Weeks 5,6 - Fuel systems, use of various fuel system parts and training aids to explain operation of port and helix, PT, and unit injector systems. Testing procedures for each type of system.

Week 7 - Commence disassembly of two cycle engine with dry liners, and four cycle engine with wet liners. Examine operation and construction details.

Week 8 - Measurements on engines used in previous sessions, using feeler gauges, dial indicator, standard micrometer, height gauges, Ames gauge and precision straight edge.

Week 9 - Reassemble engines as convenient, using correct procedures and torqueing methods.

Week 10 - Engine tune up, tune up procedures and the correct use of factory service manuals to attain optimum performance.

Week 11 - Practice on engine tuning.

Week 12 - Examine turbo chargers, blowers, various types of starter devices, marine gears and power-take-off units, cooling systems, heat exchangers, keel cooling, sea chests.

Week 13 - Trouble shooting, recognition and correct remedial procedures for common failures, emphasis on emergency repairs at sea.

6. Textbook

Diesel Engineering Handbook, 12th ed., 1971, by Carl W. Stinson, pub. by Diesel Publications Inc., Stanford, Conn.

7. Handouts

Mimeographed material amplifying the text is used during laboratory sessions.

8. References and Additional Reading Material

- a. Diesel Engine Operation and Maintenance, by V. L. Maleev, Pub. by McGraw Hill, New York.
- b. Small Boat Engines, Inboard and Outboard, by Conrad Miller, Pub. by Sheridan House, New York.
- c. Factory service manuals for engines used in laboratory.

9. Visual Aids and Other Materials

- a. Demonstration models and charts of diesel engine operating principles.
- b. Sets of slides and overhead projector transparencies of engine construction and systems operation for various engine models.

- c. Spare parts for various engine makes and models.
- d. Cutaway working models of Caterpillar and GM diesel engines.

10. Equipment List

- a. Working diesel engines: 2-GM 6-71, 1-CAT D330, 1-Cummins C160, 1-Superior 4 cylinder, 1-Lister SL1.
- b. Marine Gear: Twin Disc MG509
- c. Power Take-off Units: 1-Rockford 35HP, 1-Rockford 200HP.
- d. Portable fuel system for engines
- e. Portable exhaust system
- f. Individual cooling system for each engine
- g. 20ft. of bench, four working positions with vises, storage under.
- h. Testing instruments: Ames cylinder gauge, 2-dial indicators, ohm meter, dwell meter, volt-amp meter, assorted temperature and pressure gauges, compression tester, manometer gauge, magnahelic gauge, set of micrometers 0 inch to 6 inches.
- i. Bench grinding machine
- j. Electric hand drills: 1 - 1/4 inch, 1 - 1/2 inch.
- k. Drill press - 1/2 inch.
- l. Come-along
- m. Jacks: 4 - 1 ton stand, 1 - 5 ton hydraulic
- n. Cylinder hone
- o. Valve spring depressor
- p. Gasket punch set
- q. Battery charger
- r. Booster cables
- s. 2 - 10 qt. galvanized pails
- t. Wrenches: 1 set 1/4 inch drive sockets, 2 sets 1/2 inch drive sockets, 4 sets 3/8 inch drive sockets, 1 set 3/4 inch drive sockets; 2 claive, 4 torque, 3 sets 3/8 inch to 3/4 inch combination, 2 sets 3/8 inch to 1-1/2 inch combination, 1 set 3/8 inch to 1-1/2 inch box, 6 assorted adjustable, 1 set starter, 1 set Allen
- u. Hand tools: 1 set cold chisels, 1 set punches, 1 carpenters square, 1 set battery tools, 2 awls, 2 sets standard screwdrivers, 1 large set taps and dies, 3 file sets, 2 hacksaws, assorted ball peine hammers, 3 soft face hammers, 3 slip joint pliers, 2 end cutters, 2 diagonal side cutters, 2 needle nose pliers, 3 vise grip pliers, 2 sledge hammers, precision straight edges.
- v. 4 - 12 volt batteries
- w. Complete combination puller set
- x. Impact driver
- y. Drill sets: 2 sets 1/64 inch to 1/2 inch, 1 set 1/2 inch to 1 inch

z. Oil cans: 1 - 2 qt., 1 - 1 qt., 4 squirt

11. Supplies

- a. Gasket material, 20 sq. ft.
- b. Spare parts as found necessary from tests.
- c. Replacement tools, etc., as necessary
- d. 10 gals. diesel fuel
- e. 30 gals. lubricating oil
- f. Rags

12. Instructors' Teaching Arrangement

Teaching work is divided into two interrelated activities.

Lecture sessions are used to provide basic understanding of the operating principles of engines and associated systems commonly used in the industry.

During laboratory classes, students, in groups of two to five, examine and test the engines and systems covered in the lecture sessions. A laboratory notebook is required; written and practical tests are used to assess students' progress.

13. Method of Grading

Laboratory notebooks and practical tests	25%
Three written tests	45%
Mid-semester and final examinations	30%

FIS 142 - MARINE ENGINEERING TECHNOLOGY II

1. Credits: 4    Lecture hours: 3    Laboratory hours: 3

Instructor: McCauley, Wing

2. Description

Introduction to hydraulics, including operation, maintenance, troubleshooting, installation, and applications. Study of basic hydraulic systems, design of common hydraulic components, and selection of components for various applications. Study and application of mechanical and hydraulic diesel powered drive units. Layout and uses of shipboard water pumps.

3. Subject Outline

a. Fundamentals

Physical laws relating to fluid power  
Plumbing hydraulic systems  
Pressure drops in hydraulic systems

b. Cylinders

Calculation of cylinder thrust  
Cylinder speeds  
Piston and rod seals  
Testing of cylinders

c. Valves

Two-way valves  
Three-way valves  
Four-way valves  
Five-way valves  
Electric, air, and hydraulic valve controls

d. Pumps

Design features of various pumps  
Driving horsepower of hydraulic pumps  
Operation and maintenance  
Mounting and drives used on hydraulic pumps

e. Motors

Design features of various motors  
Operation and maintenance  
Mounting and drives used with motors

f. Accessories

Filtration in a hydraulic system  
Accumulators  
Heat exchangers

g. Welding and burning

Electric welding  
Gas welding  
Burning

4. Lecture Outlines

Week 1 - Physical laws relating to fluid power;  
effects of heat on fluids, compressibility of fluids,

transmission of fluid power, calculation of hydraulic pressure, hydraulic leverage, static head pressure.

Week 2 - Fluid flow in pipes, plumbing hydraulic systems, selecting plumbing size for various systems.

Week 3 - Pressure drop in pipes, valving, automatic systems, pressure circuits, hydraulic fluids.

Week 4 - Calculating cylinder thrust, cylinders working at an angle, cylinder speeds, directional control of cylinders, speed control of single and double acting cylinders.

Week 5 - Dividing fluid between two cylinders, cylinder types, standard mounting of cylinders, piston seals, cylinder rod packings.

Week 6 - Cushioned cylinders, 2:1 ratio cylinders, designing with cylinders, testing of cylinders, unit pressure and total pressure in cylinders.

Week 7 - Two-way directional control valves, three-way directional control valves, fluid motor control with three-way valves, physical appearance of three-way valves, pressure control valves.

Week 8 - Accessory valves, two-way direct acting and pilot operated solenoid valves, four-way directional control valves, two, three and four position four-way spool valves, miscellaneous four-way valves.

Week 9 - Methods of actuating fluid power valves, button bleed operating principles, four-way solenoid valves, four-way valve circuits, solenoid valve circuits.

Week 10 - Hydraulic pumps and motors, manual and powered pumps, action of hydraulic pumps and motors, unloading of pumps and motors. Driving horsepower of pumps and motors, alignment.

Week 11 - Direction of rotation of pumps and motors, side load with belts and gears, pump suction design, supercharging, starting a new system, external drains.

Week 12 - Hydraulic oil reservoirs, accessories for oil reservoirs, filtration in a hydraulic system, filtering circuits.

Week 13 - Accumulator construction, accumulator circuits. Heat exchangers, calculating heat loss in the system. Accessory valves for sequencing, unloading, etc.

#### 5. Laboratory Projects

Week 1 - Gas cutting and welding; correct method of assembly for oxy-acetylene torch outfit, explanation of safety procedures used in operation of the torch and the correct method of using the torch while cutting and welding.

Week 2 - Brief explanation of the electric welding operation and the various types of welding. Correct selection of electrodes, and safety procedures to be

used. Correct methods for welding.

Week 3 - Piping, correct use of pipe cutting and threading equipment. Introduction to various pipe fittings and the correct use of pipe wrenches.

Week 4 - A practical piping job is undertaken by the students to increase their proficiency in piping techniques.

Week 5 - Care and maintenance of tools including sharpening of cutting tools and the repair of broken equipment.

Weeks 6-11 - Students spend alternate weeks in the welding room practicing gas welding, cutting, and electric welding. Alternate weeks are spent on building practical hydraulic systems on the hydraulic set-up bench. Projects in hydraulics include: use of three-way valve to turn a motor on and off, use of three-way valves to control a cylinder, use of open and tandem centered four-way valve to control a cylinder, use of closed centered four-way valve to control a cylinder, use of two four-way closed center valves in parallel to operate two cylinders by one valve and a motor by the other, use of three four-way tandem center valves in series to operate a motor and then two cylinders (power beyond).

Weeks 12,13 - Students disassemble and inspect various hydraulic pumps, motors, valves and cylinders to gain an appreciation of the operating procedures and construction for the various types of apparatus.

6. Textbook

Industrial Fluid Power Text Vol. 1, 9th printing, 1970, by Charles S. Hedges, pub. by Womack Educational Publications, Dallas, Texas.

Fluid Power Data Book, 1st ed. written and pub. by Womack Educational Publications, Dallas Texas.

7. Handouts

a. Mimeographed material prepared by the instructor, used during lecture and laboratory classes; includes schematics of hydraulic circuits and a formula sheet.

b. Victor's Welding, Cutting and Heating Handbook, by Victor Welding and Cutting Division, Denton, Texas.

c. Hobart's Vest Pocket Guide, by Hobart Welding Co., Troy, Ohio.

8. References and Additional Reading Material

a. Industrial Hydraulics, 2nd ed. by John J. Pippenger and Tyler G. Hicks, pub. by McGraw Hill Book Co., New York.

- b. Simplified Hydraulics, 1st. ed., by L. S. McNickle Jr., pub. by McGraw Hill Book Co., New York.
  - c. Standard Industrial Hydraulics Questions and Answers, 1st ed., by Stephen M. Elonka and Orville H. Johnson, pub. by McGraw Hill Book Co., New York.
  - d. Vicker's Industrial Hydraulics Manual, 1st ed., Vicker's Division, Sperry Rand Corp., Troy, Mich.
9. Visual Aids and Other Materials
- a. Set of 216 slides accompanying text.
  - b. Set of 285 slides by Vicker's Division of Sperry Rand Corporation, Troy, Mich.
  - c. Films by Vicker's Division of Sperry Rand Corp.: Hydraulic Circuits, Flow Controls, Pressure Controls, Directional Controls, Vane Pumps, Hydraulic Actuators, Basic Hydraulic Principles, Hydrostatic Transmissions.
  - d. Cutaway pumps, valves, motors, cylinders.
  - e. Transparent valves in plastic housings to show construction and operating principles.
10. Equipment List
- a. Electric Welding Machines: 1 - 200 amp a.c./d.c., 1 - 180 amp. a.c.
  - b. 2 sets oxy-acetylene welding torches
  - c. Portable weld grinding machine
  - d. Bench grinding machine
  - e. Drill press: 1/2 inch.
  - f. Electric hand drills: 1 - 1/2 inch, 1 - 1/4 inch
  - g. Come-along
  - h. 20ft. of bench, four working positions with engineers vises.
  - i. 2 pipe vises
  - j. Jacks: 4 - 1 ton stand, 1 - 5 ton hydraulic
  - k. 2 sledge hammers
  - l. Piping and welding tools: pipe cutter 1/2 inch to 2 inch, pipe reamer, pipe die stock and dies 1/2 inch to 2 inch, assorted pipe wrenches, 4 pairs welders vise grips, 2 sets tubing wrenches, 2 tube flaring kits, 2 thread files, 2 sets thread chasers.
  - m. Cylinders: single acting, double acting, two rod; assorted diameters and strokes.
  - n. Pumps and motors: orbital, piston, axial piston, balanced vane, unbalanced vane, double gear, triple gear, gear rotor; assorted capacities.
  - o. Valves: two-way, three-way, four-way, selector, diverter, ball, needle, gate, pressure relief, check, flow control, unloading, sequence, counter-balance, brake; assorted sizes.
  - p. Complete backhoe unit to demonstrate use of cylinders.

- q. Complete winch, mast and boom assembly to demonstrate use of hydraulics applied to fishing vessel situations, including motors, air controls, cylinders, winches.
- r. Five-position self-draining hydraulic set-up bench driven by 30HP electric motor with pump supplying 15 gpm at 1000 psi.
- s. Heat exchanger
- t. Accumulator
- u. Assorted temperature and pressure gauges
- v. 2 - 10 qt. galvanized pails
- w. Tools: see FIS 141 listing

11. Supplies

- a. Hydraulic oil: 30 gals.
- b. Hydraulic hose: lengths of flexible hydraulic hose with end couplings as appropriate
- c. Steel piping of various diameters as appropriate
- d. Steel: 1000 lbs. oddments
- e. Welding rod: 100 lbs. assorted
- f. Gas: 1800 cu.ft. oxygen, 800 cu.ft. acetylene
- g. Replacement fittings for hydraulic components as necessary
- h. Replacement tools as necessary

12. Instructors' Teaching Arrangement

Lecture sessions are concerned with the coverage of basic principles of hydraulics and their application to the machinery and operations required aboard a fishing vessel.

Laboratory classes emphasize practical proficiency in standard shipboard activities used in the construction and installation of hydraulic systems and equipment. A laboratory notebook is required.

13. Method of Grading

Laboratory notebook and performance	15%
Mid-semester examination	40%
Final Examination	45%



FIS 151 - FISH TECHNOLOGY

1. Credits: 4    Lecture hours: 3    Laboratory hours: 3  
Instructor: Meade
2. Description  
Introduction to microbiology and biochemistry as they relate to spoilage of fish. Preservation and processing methods at sea and ashore. Plant sanitation and quality control. Processing of industrial fish.
3. Subject Outline
  - a. Introduction
    - Fish as living animals
    - Composition of fish
    - Proteins and amino acids
    - Fish lipids
    - Vitamins, inorganic compounds and water
    - Fish and physics
    - Elements of bacteriology
    - Elements of food bacteriology related to fishery products
    - Role of global fisheries in food and economics
  - b. Handling of fresh fish at sea and ashore
    - Handling aboard the vessel
    - Deck and fish rooms, outfit and equipment
    - Handling at the shore plant
    - Storage
    - Transportation
    - Distribution
  - c. Refrigeration, freezing and cold storage of fishery products
    - Refrigeration equipment
    - Refrigeration requirements and freezing methods
    - The freezing process
    - Freezing fish at shore plants and at sea
    - Packaging
    - Distribution
    - Marketing
  - d. Processing of fish and fish products
    - Smoking
    - Salt curing
    - Drying
    - Canning
    - Prepared precooked products
  - e. Processing of shellfish and crustacea
    - Shrimp
    - Crabs and lobsters
    - Scallops, clams, etc.

f. Fishery by-products technology

Production of fish liver oil  
Fish reduction industry  
Fish meal and oil  
Condensed fish solubles  
Hydrolyzed fish products  
Fish protein concentrate  
Marine plant products

g. Other topics

Retail quality of products  
Factory ship operation  
Marine mammals

4. Lecture Outlines

Week 1 - Class introduction. Directed discussion of fish as living animals. Composition of fish; yields, proximate composition, classification by composition. Introduction to protein. Proteins and amino acids; classes of proteins, characteristics, types of proteins in fish. Amino acid composition of different proteins. Amino acid classification--chemical and nutritional.

Week 2 - Fish lipids; classes of lipids, structure and composition of neutral triglycerides, glycerol, fatty acids and phosphatides; methods of determination. Vitamins, inorganic compounds and water. Fish and physics. A basic review of rules and laws governing heat as it relates to refrigeration.

Week 3 - Elements of bacteriology. A basic introduction to the subject, classification and definition, aerobic - anaerobic. Psychrophilic, mesophilic and thermophilic bacteria and their significance in fish preservation and processing. Pathogenic and non-pathogenic bacteria. Elements of food bacteriology as related to fishery products. Global fisheries and their role in national economics and food supply.

Week 4 - Handling of fish aboard the vessel. Deck and fish room designs and equipment, insulation of holds, mechanical refrigeration. Handling fresh fish at the shore plant. The importance of maintaining low temperatures.

Week 5 - Storage, transportation and distribution of fresh fish. Refrigeration equipment. Basic theory of compression and absorption systems, refrigerants. Refrigeration requirements and freezing methods.

Week 6 - Purpose of freezing fish, what happens when fish is frozen, how to make a good product, freezing, storing frozen fish. Freezing fish at shore plants and at sea. Protective coverings for frozen fish.

Week 7 - Distribution and marketing of frozen fish products. Smoking, purpose, method, scientific

aspects, products. Salt curing, principles of salt curing, spoilage of salt fish, drying of salt fish. Week 8 - Drying, stockfish, dried salted cod, vacuum drying, freeze drying, air drying and accelerated drying. Canning, to include: preparation, exhausting, sealing, heat processing, causes of spoilage and related matters. Fish sticks, fried fillets, and precooked products.

Week 9 - Shrimp: commercial species, handling, and storage on the trawler, canning, freezing, peeling, deveining, and dehydration, by-products. Crabs and lobsters; general characteristics; the crab fisheries: blue crabs, king crabs, dungeness crab, stone crab, and red crab. Lobsters: northern lobster, and spring or rock lobster. Handling, processing and storage. Scallops, oysters, clams, and mussels. Harvesting and processing of oysters, clams, and scallops. Mussels--a potential shell fishery.

Week 10 - The production of fish liver oil; historical, direct steaming, alkali digestion, acid digestion, enzyme digestion, and solvent extraction. Processing low oil content livers. Types of cod liver oil. Vitamins A & D. Role of synthetic vitamin A & D. Present day operations. The fish reduction industry and its significance to world fisheries. The production of fish meal and oil. Wet reduction.

Week 11 - The production of fish meal and oil. Dry reduction and other methods. The production of condensed fish solubles. Historical role as a source of vitamins and unidentified factors, process equipment, use in production of fish meal, problems in dehydration. The production of hydrolyzed fish products. Production of pet foods and related products.

Week 12 - Fish protein concentrate--methods for production. Fish protein concentrate--standards, nutritive value, socio-economic aspects. Processing marine plant products. Seaweeds, classification, uses in food, feed, fertilizer, and chemicals.

Week 13 - Problems relating to quality at the retail level. Factory ship operation. Technological aspects of processing at sea. Marine mammals. Seals and whales.

Week 14 (if available) - Special topics and review of course.

##### 5. Laboratory Outline

Principal activities during the laboratory sessions involve bi-weekly, full day field trips and demonstration visits, which are timed to mesh with the progress of lecture material throughout the course. Visits include:

Fish landing docks and ice plants  
 Fish stick and portion production plants  
 Food fish processing (filleting) plants  
 Fish reduction plants  
 Fish protein concentrate plant  
 Lobster holding and processing plant  
 Technological Laboratory, National Marine  
 Fisheries Service

6. Textbook  
Fish Handling and Processing, G. H. Burgess, C. L. Cutting, J. A. Lovern, J. J. Waterman, pub. by HMSO, Edinburgh, 1965.
7. Handouts  
 Mimeographed notes.
8. References and Additional Reading Material
  - a. Industrial Fisheries Technology, ed. M. Stansby, Academic Press.
  - b. Fish in Nutrition, ed. E. Heen and R. Kreuzer, Fishing News (Books), London.
  - c. Technology of Fish Utilization, ed. FAO, Fishing News (Books), London.
  - d. Fishery By-Products Technology, ed. J. Brody, Academic Press.
  - e. Microbiology of Foods, by F. Tanner, Garrard Press.
  - f. Fish Quality at Sea, ed. and pub. by Grampian Press, London.
  - g. Fishery Leaflets: 427, 428, 429, 430, 431, 584, National Marine Fisheries Service, Washington, D.C.
  - h. "U.S. Fish Industry CFTL 14," National Marine Fisheries Service, Washington, D.C.
  - i. Journal of the Fisheries Research Board of Canada, 21(6), 1964; 19(6), 1962.
9. Instructor's Teaching Arrangement  
 Teaching work consists primarily of the lecture sessions supported by field trips arranged to coincide with the appropriate subject material of the lectures. The class meets for three separate one-hour lecture periods each week. Term papers on subjects related to fishery technology are required. A total of six tests are given following coverage of each major subject area, in addition to a final examination.
10. Method of Grading

Six tests, mid-semester and final exams	60%
Class participation	20%
Term paper	20%

FIS 161 - MARINE ELECTRONICS

1. Credits: 3    Lecture hours: 2    Laboratory hours: 3

Instructor: Merriam

2. Description

Basic electricity applied to fishing. Basic solid state and vacuum tube electronics, d.c. and a.c. machinery, ship wiring, communications, depth and fish finders, radar, electronic navigation systems. Noise control, siting and preventive maintenance of equipment.

3. Subject Outline

a. Basic electricity

The atom, electron, proton and ion  
Electric charge  
Laws of electrostatics  
Electric current (charge flow)  
Electric pressure  
Electric power  
Primary cells  
Electric resistance (Ohm's Law)  
The electric circuit; series and parallel connections  
Voltage drop

b. Magnetism

Laws of magnetism  
The magnetic circuit  
The magnetic compass  
Magnetic field of a conductor  
Solenoid  
Motor action  
Generator action  
Electric instruments:  
The voltmeter  
The ammeter  
The wattmeter  
The Ohmmeter

c. The lead acid storage battery

Purpose  
Principle of operation  
Care and maintenance

d. Marine corrosion

Galvanic action  
Stray current corrosion

e. Marine electric systems

Voltage regulation and wire size  
Wiring standards  
Color coding  
Circuit diagrams  
Fuses and circuit breakers

- f. D.C. machinery
  - Shunt motors
  - Series motors
  - Speed torque and load characteristics
  - Speed control
  - The shunt generator
  - The reverse current relay and regulator
- g. Alternating currents
  - Frequency
  - Period
  - Inductance and capacitance
  - The alternator
  - The diode
  - The solid state regulator
  - The electromagnet spectrum
- h. Radio communication
  - The spectrum continued
  - Radiation
  - Antennas and grounds
  - Detection
  - AM, FM & SSB
  - Communication law and radio operating practice  
(elements I & II of FCC license)
- i. Ultra sonic devices
  - Sound transmission in water
  - The indicating depth finder
  - The recording depth finder
  - The white line and high power fish finding recorder
  - The fishscope
  - Sonar
  - Net sounding gear
- j. Electronic navigation systems
  - Loran
  - Decca
  - Omega
  - Radar

4. Lecture Outline

Week 1 - The atom, electron, proton, ion, electric charge, laws of attraction and repulsion, and charge flow.

Week 2 - The primary cell, electric potential, the volt, electric power and electric resistance.

Week 3 - Ohm's Law, the electric circuit, series, parallel, and series-parallel connections.

Week 4 - Laws of magnetism, the magnetic circuit, the compass, the magnetic field of a moving charge, motor action, generator action, electric instruments-- the voltmeter, the ammeter, the wattmeter, and the ohmmeter.

Week 5 - Complete marine electric systems, choice of voltage, voltage regulation, wire size and insulation requirements, wiring standards, color coding, fuses and circuit breakers, overall circuit diagrams.

Week 6 - The lead acid storage battery, its reversible chemical reaction, specific gravity, Faraday's Law, care and maintenance of wet cells.

Week 7 - Marine corrosion, galvanic action, and stray current corrosion. Rules for inhibiting corrosion. Bonding systems and grounding.

Week 8 - D.C. machinery, the shunt motor and the series motor, speed and torque characteristics, speed and direction control. The shunt generator, field control, the regulator and reverse current relay.

Week 9 - Alternating currents. Frequency and period. How a.c. is generated. The alternator, the diode, and the solid state regulator.

Week 10 - Alternating currents, the electromagnet spectrum and the placement in it of the various kinds of marine electronic equipment. Radiation, antennas, tuning and detection. CW, AM, FM and SSB.

Week 11 - Communications law and proper radio operating procedure.

Week 12 - Ultra sonic devices in marine applications. The depth finder including the indicator, the recorder, the white or gray line recorder, the multi stylus recorder, the fishscope, the sonar, and net sounding equipment.

Week 13 - Electronic navigation systems, the direction finder, Loran, Decca, Omega and Radar.

Week 14 (if available) - Miscellaneous devices, such as hailers, auto pilots, and static chargers.

#### 5. Laboratory Projects

Weeks 1,2 - Familiarization with electrical laboratory equipment. The adjustable bench d.c. supply, measuring instruments and their care, clip leads. Connection of source to load in various ways and the observation of the relationship between voltage and current.

Week 3 - Magnetism and relays. The compass as a detector of magnetism, the field of a moving charge, righthand rule. Making an electromagnet, a buzzer, a relay, and a simple telegraph.

Week 4 - Wiring practice. Use of lugs and lug tools, soldering. Calculating and measuring voltage drop using wire of various sizes and lengths.

Week 5 - Wiring practice. The complete marine electric system, choice of voltage, switchboard layout and protection devices.

Week 6 - Lead acid storage battery and corrosion. Study cell structure. Charge and discharge laboratory

model cell. Determine ampere-hour capacity and resistance of this cell. Use of hydrometer. Make galvanic couple in sea water and observe rate of corrosion. Introduce stray current and observe rate of corrosion.

Week 7 - Direct current motors and generators. Connect shunt motor, observe speed and torque characteristic. Connect series motor, observe speed and torque characteristic. Study internal connections and methods to reverse direction of rotation. Connect shunt generator and determine field current vs. output voltage characteristic.

Week 8 - Alternating currents. Familiarization with laboratory oscilloscope. Use variable frequency oscillator and observe wave form, amplitude and frequency changes on oscilloscope. Repeat with crystal oscillator and multivibrator. Detect low frequency a.c. with speaker and with large galvanometer coil. Observe motor action. Set up 2-pole a.c. generator and demonstrate validity of:  $f = \frac{P \times \text{RPM}}{120}$

Week 9 - Capacitors and inductors. Inspect physical construction of several kinds of capacitors. Set up RC circuit to demonstrate time constant. Set up make and break ignition system to demonstrate:  $L \frac{di}{dt}$  Measure peak voltage developed. Operate jump spark ignition system and observe value of capacitor in coil primary. Demonstrate resonance with coil and capacitor.

Week 10 - Radio. Build simple crystal receiver. Observe function of tuning. Study parts layout of modern radiotelephones, both AM and VHF FM. Trace signal paths. Operate radios into dummy loads.

Week 11 - FCC license study. Practice operating and review laws.

Week 12 - Depth and fish finders. Examine several types in detail. Trace signal with oscilloscope. Study operation of Simrad white line recorder and fishscope on test range in laboratory. Operate F80 with Basdic head, measure sonar beam width.

Week 13 - Radar. Dismantle laboratory unit to analyze function of parts. Reassemble and place into operation. Check magnetron output. Study rotation and sweep systems. Work plotting problems.

6. Text Books

- a. Delco Remy Training Series, Books a, b, c, d, e, j.
- b. Small Boat Electronics, pub. by the Engineering Press, E. Greenwich, R.I.

7. References and Additional Reading Material

- a. Echo Sounding at Sea, by H. Galway, pub. by Sir



- Isaac Pitman & Sons, London, England.
- b. An Introduction to Echo Sounding, pub. by ELAC (Electroacoustic GMBH), Kiel, Germany.
- c. Fish Finding With Sonar, pub. by SIMRAD (Simonsen Radio A.S.), Oslo, Norway.
- d. Radar and Electronic Navigation, by G. J. Sonnenburg, pub. by D. Van Nostrand Co., Inc., Princeton, New Jersey.

8. Visual Aids and Other Material

- a. Series of charts by Delco Remy accompanying text.
- b. Series of slides on sonar prepared by SIMRAD
- c. Visual aids prepared by instructor.

9. Equipment List

- a. 2 Bendix MR3 radar sets
- b. 1 Simrad Partner sounding machine with Simrad scope and simulator
- c. 1 VHF FM radio telephone
- d. 2 Kelvin Hughes LJ-11 loran sets
- e. 1 Kelvin Hughes loran simulator
- f. 1 APN9 loran set
- g. 1 Basdic F80 fish finder
- h. 1 RDF loop combined with multi-band receiver
- i. 2 Oscilloscopes
- j. Simulated fishing vessel electrical system including alternator, generator, starter, ignition system, shore charge system, vessel lighting and power distribution systems.
- k. Assorted a.c. and d.c. motors
- l. Four laboratory working positions for student groups of 2 to 3, containing variable source of direct current power, voltmeter, ammeter, test leads, tool kit.

10. Instructor's Teaching Arrangement

Two one-hour lecture sessions and one three-hour laboratory session are undertaken each week with the lecture material directly related to the laboratory exercises. The course aims at providing students with a basic understanding of electricity and its application to fisheries use, with emphasis on correct procedures and trouble shooting of equipment. A laboratory notebook is kept to coordinate lectures and laboratory exercises. Problem assignments are provided each week.

11. Method of Grading

Laboratory notebooks and performance	20%
Twelve quizzes	30%
Home problem assignments	10%
Mid-semester and final examinations	40%

FIS 171 - VESSEL TECHNOLOGY

1. Credits: 4    Lecture hours: 3    Laboratory hours: 3

Instructor: Sainsbury

2. Description

Flotation principles, the lines plan, detailed treatment of stability, use of hydrostatic and stability information. Powering, propeller selection. Construction in wood, steel, ferro concrete and GRP. Introduction to vessel economics leading to choice of size and particulars.

3. Subject Outline

a. Principles of flotation

Archimedes principle  
Tonnage  
Displacement  
Buoyancy  
Center of gravity  
Center of buoyancy

b. Hull geometry

Definitions  
Moulded dimensions  
The lines plan  
Draft  
T.P.I.  
Center of flotation  
Form coefficients

c. Stability

Conditions of equilibrium applied to a vessel  
Metacentric stability, GM  
Stability beyond the metacentric range  
Statcal stability curve  
Cross curves of stability  
Dynamical stability  
V.C.G. and its importance  
Effect of swinging weights  
Effect of liquid and fish cargo free surfaces  
The inclining experiment  
Effect of icing up  
Loading conditions  
Stability booklet  
Initial instability  
List and loll  
Stability at sea  
Desirable stability characteristics  
IMCO criteria  
Stability when grounded

d. Trim

Change of trim

- Longitudinal movement of weights
  - Addition and removal of weights
  - Calculation of drafts
  - Grounding
  - e. Hydrostatic information
    - Hydrostatic curves
    - Displacement and drafts
    - C of F correction
  - f. Powering
    - Hull types
    - Resistance and its component parts
    - E.H.P.
    - Engine B.H.P. rating
    - Transmission of power to propeller
    - Allowances
    - SHP/speed estimates for displacement hulls
    - Towing power requirements
    - Effect of form factors on speed and power
    - Estimating speed and power for planing craft
  - g. Marine propellers
    - Definitions and geometry
    - Clearances
    - Operating conditions
    - Choice of propeller to suit individual vessel
    - Towing
    - Propeller selection
    - Cavitation
    - Controllable pitch propellers and the Omega gear
    - Nozzles
    - Shafts
  - h. Construction
    - Forces acting on vessel afloat and ashore
    - Desirable construction properties
    - Construction in wood
    - Construction in steel
    - Construction in aluminum
    - Construction in G.R.P.
    - Construction in ferro concrete
    - Comparison of materials
  - i. Vessel planning
    - Use of economic data to choose type and size
    - Dimensions
    - Power
    - Layout
4. Lecture Outlines
- Week 1 - The lines plan and its use; perpendiculars, molded dimensions and lines; sections, waterlines, bow and buttock lines, diagonals; the body plan, the half-breadth plan, the sheer plan; relationship between plans, the fair ship.

Week 2 - Flotation balance; gross and net tonnage, displacement, deadweight, light ship, calculation of CG for given deadweight make-up.

Week 3 - The stable and unstable ship, righting moment and righting lever, the metacenter and GM; stability beyond the metacentric range, the GZ curve; factors affecting the GZ curve, cross curves of stability and their use; dynamical stability.

Week 4 - Effect on stability of moving weights and swinging weights; free surface of liquids and fish cargoes, use of longitudinal bulkheads to control free surface, effect of deck cargoes. Icing up, its control and effect on stability.

Week 5 - Practical loading conditions for fishing vessels, the stability booklet and its use; control of KG under practical conditions; recognition and correction of list and loll; stability at sea; desirable stability characteristics for a fishing vessel, IMCO stability recommendations.

Week 6 - Theory and use of the inclining experiment, use of rolling period to assess stability; change of trim and draft due to movement of weight, drafts following addition and removal of weight; drafts, force on hull, and stability when grounded.

Week 7 - Description of displacement, transitional and planing hulls; resistance characteristics of displacement hull, frictional and residual resistance; engine power rating; breakdown of power loss between engine and propeller; shp/speed relationship for displacement hull, speed/power estimates, power required when towing fishing gear.

Week 8 - Description and definitions for marine propellers; propeller characteristics and charts, speed of advance, passage and towing conditions for propeller operation.

Week 9 - Propeller selection and performance while on passage and towing; bollard pull; cavitation, loading; use of controllable pitch propellers and Omega gear, use of nozzles, shaft size.

Week 10 - Operational economics, costs and earnings, effect of catch rate and price structure on optimum vessel size; choice of vessel type and dimensions, general arrangement, deck layout, engine room requirements, crew quarters, hold space.

Week 11 - Longitudinal and transverse stresses when afloat and out of the water; local stresses; arrangement of structure to combat working stresses; desirable structural characteristics. Standard wooden fishing vessels of sawn and bent frame construction. The midship section and profile section construction plans.

Week 12 - The use of steel and aluminum as fishing vessel construction materials; construction of typical fishing vessels of steel and aluminum; mid-ship section and usual plans.

Week 13 - The use of ferro cement and G.R.P. for fishing vessels; survey of constructional methods, typical plans. Comparison of fishing vessel construction materials from viewpoints of cost, maintenance, life, flexibility.

Week 14 (if available) - Survey of important factors not considered in previous coursework, including the effect of flooding and damage control, ship motions and roll stabilizing systems.

5. Laboratory Projects

Weeks 1,2 - Project No. 1 - Hydrostatic Properties of a Vessel I - Study and use of the lines plan. Simpson's first rule and its use to calculate areas and centroids of waterplanes and sections. Construction of certain hydrostatic curves.

Week 3 - Project No. 2 - Hydrostatic Properties of a Vessel II - Use of Simpson's first rule to calculate volumes and centroids of the hull. Calculation of form coefficients. Construction of further hydrostatic curves.

Week 4 - Project No. 3 - Hydrostatic Properties of a Vessel III - Use of Simpson's first rule for moments of inertia of a waterplane; calculation of  $BM_L$ ,  $BM_T$ ,  $MCT 1''$ ; completion of hydrostatics. Calculation of  $GM_T$ .

Week 5 - Project No. 4 - Stability I - Calculation of displacement, VCG, LCG and mean draft for a loading condition; tank free surface correction; use of hydrostatic curves to calculate GM; use of cross curves and isocline curves to obtain statical stability curves.

Week 6 - Project No. 5 - Stability II - Dynamical stability; IMCO stability criteria; calculation of drafts for loading conditions; the stability booklet; effect of icing up.

Week 7 - Project No. 6 - The Inclining Experiment - Conduct of inclining experiment and the reduction of results to find the lightship displacement, KG and LCG. Expansion of lightship particulars to determine characteristics for range of operating conditions. Rolling period and constant.

Week 8 - Project No. 7 - Powering - Free running shp/speed estimates using simplified data. Repowering estimates. Power required when trawling.

Week 9 - Project No. 8 - Propeller Selection - Propeller performance curve. Selection of propeller for free running and its performance when towing.

Selection of propeller for maximum towing pull and its performance on passage.

Weeks 10-13 - Project No. 9 - Vessel Planning - Use of economic data to determine optimum vessel size for chosen operation. Choice of vessel type, principal dimensions and particulars. Selection of propulsion, auxiliary and deck machinery. General arrangement, deck layout, fishing and gear handling operations, engine room layout, accommodation. Above water profile.

6. Textbooks  
Stability and Trim of Fishing Vessels, J. Anthony Hind, Fishing News (Books) Ltd, London.
7. Handouts (Duplicated Material)
  - a. Mimeographed lecture notes
  - b. Mimeographed laboratory handbook
  - c. "Intact Stability of Fishing Vessels," U.S. Coast Guard Navigation and Vessel Circular 6-68.
  - d. "De-Icing Equipment Tested in Arctic Waters," Xerox from Norwegian Maritime News.
  - e. "Norway's Answer to Arctic Icing," Xerox from Fishing News.
  - f. Ship Stability, Notes and Examples, Kemp and Young, Kandy Publications, London.
  - g. "Stability and Seaworthiness of Fishing Vessels," Xerox from Norwegian Maritime News.
  - h. "Advantages of CP Propellers," Xerox from Fishing News.
  - i. Midship section and profile construction plans for 90 ft. Eastern Rig Dragger, Jack Gilbert.
  - j. Construction plans for 65 ft. Wood Combination Vessel, W. M. Reid.
  - k. Lines plan and construction plans for 74 ft. Steel Trawler, Atlantic Marine.
  - l. Profile arrangement for 74 ft. GRP Trawler, Hatteras.
8. References and Additional Reading Material
  - a. Marine Library Series, pub. by Detroit Diesel Div. of General Motors:
    - Book 1. Elements of Marine Propulsion
    - Book 2. Propeller Selection Guide
    - Book 3. Marine Engine Installation Facts
  - b. Publications of Caterpillar Tractor Co.
    - Introduction to Marine Propulsion
    - Caterpillar Marine calculators: "hull speed estimator," "marine propeller basic size and speed selector," "propeller slide rule."
    - Cat. Marine engine application and installation guide.

- c. Boatbuilding Manual, by Steward, Poseidon Publishing Co.
  - d. Small Steel Craft--Design, Construction & Maintenance, by Nicholson, pub. by Adlard Coles Ltd., London.
  - e. Aluminum Boats, by Kaiser Aluminum.
  - f. "Marine Aluminum Applications," by C. W. Leveau, SNAME Calif. sec.
  - g. "Construction of Ferro Cement Motor Sailer Hull," L'Ingenieur, May 1970.
  - h. How to Build a Ferro Cement Boat, Samson and Wellens, pub. Samson Marine Design Enterprises, Vancouver.
  - i. Concrete Boatbuilding, Its Technique and Its Future, by Jackson and Sutherland (from International Marine Pub. Co.).
  - j. "Repairs to Fibreglass Boats" and "Maintenance of Fibreglass Boats" by Boughton Cobb Jr., Owens Corning Fibreglass Corp.
  - k. Rules for Building and Classing Steel Vessels, American Bureau of Shipping.
  - l. "Guidelines for Building and Classing Aluminum Vessels," ABS.
  - m. "Guidelines for the Construction of Ferro Cement Vessels," ABS.
9. Visual Aids and Other Materials
- a. Slides of construction of wood vessel "Hero"
  - b. Slides of steel construction
  - c. Slides of aluminum construction
  - d. Slides of GRP construction
  - e. Slides of ferro cement construction
  - f. Propeller
10. Equipment List
- a. Drawing table and stool for each student position
  - b. Vessel for inclining experiment, weights, pendulum, etc.
11. Laboratory Layout  
Usual drawing office or Navigation Lab layout--one bench per student.
12. Supplies
- a. Lines plan of particular vessel ("Gail Ann")
  - b. General arrangement of particular vessel ("Gail Ann")
  - c. Scale rules with correct divisions for lines plan scale.
  - d. Work sheets for Simpson's rule calculations (mimeographed)
  - e. Vessel particulars for 120 ft. side trawler

- and 65 ft. wood combination vessel
- f. Stability booklet blank sheets for vessels in (a) and (e)
- g. Speed/power worksheets from GM book No. 1.
- h. Worksheets of  $B_p$  and coefficient charts for standard propellers
- i. Squared paper for vessel planning

13. Instructor's Teaching Arrangement

Teaching work is divided into two interrelated activities--lecture sessions and laboratory sessions, with two meetings each week.

First meeting, 1-1/2 hour lecture - Devoted to coverage of course material. Students are normally supplied with relevant reading assignments one week in advance and are expected to familiarize themselves with the assigned topics. Class time is used to emphasize important theoretical aspects and discuss their application to practical conditions associated with fishing vessels and fishing operations. Detailed calculations and examples are not normally considered in this session, being covered in the second meeting period each week.

Second meeting, 1 hour lecture, 2-1/2 hours lab - Class time is used for (1) discussion of points and questions raised by students regarding course material covered in the previous lecture, (2) distribution, collection and discussion of assignments and tests, (3) introduction of the associated laboratory project.

A set laboratory project is arranged each week. Basic project work is undertaken during the time period, with students being expected to complete the assignment and write up the report for presentation the following week. Laboratory projects cover the application and detailed calculations associated with subject matter previously introduced in lectures and are arranged to follow the course layout throughout the semester.

14. Method of Grading

Two tests	20%
Mid-semester and final examinations	40%
Laboratory notebook and performance	40%



FIS 181 - NAVIGATION I

1. Credits: 4    Lecture hours: 2    Laboratory hours: 4

Instructor: Motte

2. Description

Fundamental rules and methods of chartwork. Chart projections and types. Position fixing, wind and tide allowance. Variation, deviation and compass error. Principle of transferred position line and doubling angle on the bow. Use of sextant angles, radar, hyperbolic, and celestial position lines for chartwork. Tidal theories and calculations involving parallel, plane and mercator sailings.

3. Subject Outline

a. Chart familiarization

Care of the chart  
Basic rules of chartwork  
Chart types  
Fishing charts  
Chart scale  
Chart projections

b. Position

Great and small circles  
Latitude and longitude  
Nautical mile and knot  
Bearings and transits  
Use of hyperbolic position lines

c. Reading a chart

Chart symbols and abbreviations  
General chart layout  
Small and large corrections  
Notices to Mariners  
Chart construction and surveying

d. Magnetism

Magnetic Variation  
Magnetic Deviation

e. Instruments

The magnetic compass  
The gyro compass  
The sextant  
Azimuth mirrors

f. Tides

Tidal theories  
Tidal calculations  
Course to counteract current

g. Practical chartwork

The running fix  
Transferring hyperbolic and sounding lines  
Distance by rising and dipping circles

- Horizontal and vertical sextant angles
- Doubling the angle on the bow
- Leading and clearing marks
- The rule of sixty
- The three bearing problem
- h. The sailings
  - Parallel sailing
  - Plane sailing and traverse tables
  - Mercator sailing

4. Lecture Outlines

Week 1 - Upkeep and maintenance of charts. Introduction to chart catalogues and publications. How to select charts for an area. Chart scale, chart types, fishing charts.

Week 2 - Mercator, Gnostic and Polyconic chart projection characteristics and applications of each. Great circle and rhumb line tracks.

Week 3 - The earth as an oblate spheroid, latitude and longitude and grid systems. Distance and the nautical mile, velocity and the knot.

Week 4 - Fixing a vessel's position near to shore using true bearings and transits. Integration of compass bearings with position lines from electronic navigational aids.

Week 5 - Reading a chart, interpretation of symbols and abbreviations. Conversion of radar P.P.I. information to charted detail. Small and large corrections, how to catalogue and update charts.

Week 6 - Basic chart construction and hydrographic surveying. Base line extension, setting up a tide pole and bench marks. Lithographic and photographic chart impressions.

Week 7 - Magnetic Variation, the magnetic course, isogonic lines and annular change. The magnetic equator and dip. The running fix applying estimated effect of tide and wind.

Week 8 - Magnetic Deviation, the compass course, hard and soft iron magnetism and compass error. Component parts of deviation, the nine rods of induced magnetism and the three components of permanent magnetism. Basic compass adjusting using the deviascope.

Week 9 - Errors, adjustment and working principles of the marine sextant. Use of azimuth and reflecting mirrors. Distance off by vertical sextant angle.

Week 10 - Tidal theories and calculations. Lunar, solar and geographical components, harmonic constants and meteorological factors. Course to steer to counteract a tide.

Week 11 - Hyperbolic position lines by loran and Decca, the principles of time and phase comparison. Radio direction finding and convergency.

Week 12 - Practical wrinkles of the navigator. Transferred position circles, the line of soundings, the four-point problem, the rule of sixty, distance estimation.

Week 13 - Logarithms and plane trigonometry and the traverse tables. Parallel and plane sailing.

Week 14 - The mercator chart, meridional parts and mercator sailing.

## 5. Laboratory Projects

Week 1 - Calculations with chart scales. Comparison of linear dimensions on plan, coastal and ocean charts.

Week 2 - Converting position by true bearing and distance from a light to latitude and longitude and vice versa.

Weeks 3,4 - Fixing position by true bearings and transits. Laying off true course to steer and distance in nautical miles from place to place. Calculations involving speed, time and distance.

Weeks 5,6 - Examination of symbols and abbreviations on the coastal charts of this area. Study of fishing charts with particular emphasis on trawling grounds. Wrecks, hazards, cautions and "hangs" important to the fisherman.

Week 7 - Exercise involving practical use of transferred position lines from electronic navigational aids, celestial reductions as well as the conventional compass bearings.

Week 8 - Constructing a curve of deviations, applying compass error to all previously worked problems and converting from true to compass and vice versa.

Week 9 - Use and care of the marine sextant. How to take vertical and horizontal sextant angles. How to check the sextant for errors. Determination of Index Error.

Week 10 - Calculations using tide tables including computation of height of tide at certain time for a secondary port, and computation of the time the tide reaches a certain height at a secondary port. Chart datum and establishing a datum, setting up a tide pole.

Week 11 - Use of loran and Decca simulators to familiarize students with operation of, and use of information from, these navigational aids.

Week 12 - Exercises and calculations on some of the more practical wrinkles of the navigator including transferred position circles, lines of soundings and distance estimation.

Weeks 13-15 - (a) General chartwork exercises, devised to present a realistic working situation for a fishing skipper and incorporating all the aforementioned material, are attempted by the student.

- (b) Exercises in Parallel, Plane and Mercator Sailing.
6. Textbooks  
Chartwork for Fishermen and Boat Operators, by G. A. Motte, University of Rhode Island Sea Grant Program, Marine Bulletin No. 7.  
Burton's Four Figure Navigation Tables, George Philip and Son.
7. Handouts (duplicated material)  
 The above concise textbook is supplemented by additional general chartwork exercises as to the individual requirements of particular students.
8. References and Additional Reading Material
- a. American Practical Navigator, by Bowditch. H.O. Pub. No. 9.
  - b. Navigation and Pilotage, by Dutton. U.S. Naval Institute.
  - c. Admiralty Manual of Navigation, Vol. I, H.M.S.O.
  - d. Nichols's Concise Guide, Vol. I, Brown Son and Ferguson, Glasgow.
  - e. Tides, by D. H. Macmillan. C.R. Books Limited.
  - f. The Oceans, by Sverdrup. Prentice Hall.
  - g. The Ship's Compass, by Grant & Klinkert. Routledge and Kegan Paul.
  - h. Plane and Spherical Trigonometry, by Nielsen and Vanlonkhuyzen. Barnes & Noble, No. 45.
  - i. The Use of Radar at Sea, by Wylie. American Elsevier.
  - j. Marine Chartwork and Nav aids, by Moore. Kandy Publications.
9. Visual Aids and Other Materials
- a. Slides and transparencies of position, solar system, tides, by Hubbard Scientific Company.
  - b. Various models and visual aids for navigational instruction by Hubbard Scientific Company.
  - c. Miniature Planetarium by Hubbard Scientific Company
10. Equipment List
- a. Chart table, stool, set of parallel rulers and dividers for each student position.
  - b. Electronic simulators for loran, Decca navigator and radar.
  - c. Magnetic compasses, deviascope, marine sextants, azimuth mirrors.

11. Laboratory Layout
- a. Normal drawing office layout with electronic navigational aids laboratory adjacent so that individual instruction may proceed during class laboratory sessions.
  - b. Training vessel outfitted with modern navigational equipment in order that classroom learning may be practically applied.
12. Supplies
- a. Sufficient charts, 1210, 1211, and 71 related to the laboratory exercises.
  - b. Renewal of parallel rulers, dividers and other tools as necessary.
13. Instructor's Teaching Arrangement
- A double session of lecture and laboratory is undertaken each week with the lecture material directly related to the laboratory exercises. The student is introduced to the various navigational tools and instruments as the relevant material is covered in the classroom. It is possible by strategic use of simulators and laboratory exercises to familiarize the student with the work and practice of the navigator before he undertakes that position on board the training vessel. Every effort is made towards this end during the instructional periods.
- The laboratory sessions during the initial periods cover the basics of vessel conduct in coastal waters. The later laboratory sessions combine the early classroom knowledge and theory into as realistic as possible navigational exercises, reflecting the daily work of the fishing skipper. A laboratory notebook is kept to coordinate lectures and laboratory exercises as well as training vessel experience.
14. Method of Grading
- |                                     |     |
|-------------------------------------|-----|
| Laboratory notebook                 | 20% |
| Three general chartwork exercises   | 40% |
| Mid-semester and final examinations | 40% |

FIS 182 - NAVIGATION II

1. Credits: 3    Lecture hours: 2    Laboratory hours: 4

Instructor: Motte

2. Description

Continuation of Navigation I. Basic astronomy applied to celestial navigation. Study of time and the solar system. Azimuth, amplitude, pole star and meridian altitude problems. Sight reduction by calculation, short method tables and inspection. Use of information from electronic aids to navigation.

3. Subject Outline

a. Solar System

Kepler's laws of planetary motion  
Bode's law  
Inferior and superior planets  
Characteristics of an ellipse

b. Earth's motion

True and apparent motion of earth to sun  
The celestial sphere  
Equinoctial and ecliptic  
The seasons  
Motion of the moon

c. Stars

Recognition of principal constellations  
True and apparent stellar motion

d. Time

Greenwich, zone and local time  
True and apparent time  
The equation of time  
Solar, sidereal and lunar time  
The civil calendar

e. Nautical Almanac

Locating a body on the celestial sphere using  
the Nautical Almanac  
Conversion of time to arc  
Use of Increment and Interpolation tables

f. Instruments

The marine sextant  
The chronometer  
Bubble sextants

g. Determination of compass error

The azimuth problem  
The amplitude problem

h. Determination of latitude

Latitude by meridian altitude  
Calculation of time of meridional passage  
Latitude by observation of the Pole Star  
Latitude by ex-meridian altitude

i. Position line navigation

The altitude/intercept method  
Spherical trigonometry and Napier's Rules  
Sight reduction by calculation, short method  
and inspection tables  
Simultaneous sights and the transferred position line

4. Lecture Outlines

Week 1 - The solar system and the universe. Kepler's first law and Bode's law. Inferior and superior planets and nodal points. Obtaining true zenith distance from sextant altitude. The zenith distance position circle.

Week 2 - The celestial sphere and true and apparent motion. Greenwich, local and zone time and construction of the civil calendar. Kepler's second and third laws.

Week 3 - Position fixing on the celestial sphere. Celestial latitude and longitude, altitude and azimuth, declination and hour angle. Sidereal, solar and lunar time.

Week 4 - The seasons, obliquity of the ecliptic, the first point of Aries, solstices and equinoxes. Motion of the moon and satellites. Construction of scale diagrams in the plane of the observer's rational horizon indicating path of bodies and meridional passage.

Week 5 - Introduction to the celestial triangle and the properties of a spherical triangle. How to determine compass error by observation of sun and stars. Use of short-method tables to find true azimuth.

Week 6 - Basic right spherical triangle calculations using Napier's Rules. The amplitude problem solved by spherical trigonometry and short-method tables. Familiarization with the principal stellar constellations.

Week 8 - A detailed analysis of the Nautical Almanac. A further and continuing study of the sextant, laws of light, errors and adjustments. (Following lectures and practical use of the sextant carried out in Navigation I.) The pole star problem.

Week 9 - A further study of time and timekeeping. Accumulated daily rate and time checks. History, basic construction and care of the marine chronometer. Introduction to the altitude/intercept method of position line navigation.

Week 10 - Sight reduction by calculation using the cosine/haversine formula.

Week 11 - Consolidation of previous lectures on electronic aids to navigation and determination of position by combination of celestial and "navaid" position

10. Equipment List  
 Draughting table and stool for each student position.
11. Laboratory Layout  
 a. Usual drawing office or Navigation Lab layout. One bench per student.  
 b. Lab situation to be such as to provide a visible sea horizon to facilitate observation of the sun.
12. Supplies  
 a. Set of H.O. 214 or H.O. 229, one for each student.  
 b. Set of Ageton's short method tables, one for each student.  
 c. Set of Nautical Almanacs for an established working year, one for each student.
13. Instructor's Teaching Arrangement  
 The two weekly lectures are conducted in conjunction with the laboratory session and progress is a function of the rate that the student body is able to absorb the practical laboratory work.  
 a. One of the weekly lectures provides the theoretical basis for the following laboratory session which is coordinated with home assignments.  
 b. The remaining weekly lecture is used to broaden the student's knowledge of the ancillary topics of mathematics and astronomy. In this applied manner it is possible to convey relatively advanced and practical trigonometric principles to students who would perhaps otherwise fail to grasp this useful topic.  
 c. The laboratory sessions deal with day-to-day problems of "deep sea" navigation. Every effort is made to present the calculations and problems in a realistic manner, utilizing the most modern and innovative approaches and techniques.
14. Method of Grading
- |                                     |     |
|-------------------------------------|-----|
| Five tests                          | 50% |
| Mid-semester and final examinations | 40% |
| Laboratory reports                  | 10% |



FIS 192 - FISHING OPERATIONS

1. Credits: 4    Lecture hours: 3    Laboratory hours: 8

Instructor: McCauley

2. Description

Principles of fishing vessel operation. Year-round, seasonal, trip, daily planning and work. Working the New England grounds for principal commercial species, including correct rigging of gear and fishing procedures. Fishing vessel management and business procedures.

3. Subject Outline

a. How to work the fishing grounds

Ranges  
Sounding machine  
Loran  
Radar  
Buoy systems  
Avoiding hangups  
Effects of tide

b. Characteristics of fishing areas

Includes gear changes and modification on:  
soft muddy bottom  
firm mud bottom  
mud ridge bottom  
level sand bottom  
coarse sharp sand bottom  
sand lump bottom  
shell bottom  
hard rocky bottom  
canyons

c. Fleet considerations

Passing vessels while towing  
Radar observation  
Fish location  
Communication  
Mobile gear versus fixed gear

d. Procedures for handling unusual situations

Excessive fish catches  
Rocks  
Mud  
Foul sets  
Rough weather  
Fouled propeller

e. Trip evaluation

Prices  
Market information  
Fishing effort by other vessels  
Catch rate  
Shelf life

- f. Vessel cost of operation
    - Trip expenses
    - Crew expenses
    - Wage determination
    - Daily cost of operation
    - Depreciation methods
  - g. Business considerations
    - Statement of income and expense
    - Balance sheet
    - Bank loans and applications
    - Investment credits
    - Taxes
    - Check records
    - Cash receipt records
    - General ledger
    - General journal
    - Coding
    - Computerized bookkeeping systems
  - h. Specific fishing grounds, hangs & tows
    - George's Banks
    - Nantucket Shoals
    - South of Block Island
    - East of New York
    - New Jersey south to Hatteras
    - Outer bank to 300 fathom
  - i. Fish migration patterns
    - Red hake
    - Whiting
    - Scup
    - Butterfish
    - Fluke
    - Yellowtail flounder
    - Blackback flounder
    - Grey sole
    - Tile fish
    - Herring
    - Mackerel
    - Lobster
    - Gear information on all the above
  - j. Vessel construction and financing
    - Contracts
    - Financing
    - Insurance
    - Registering
    - Measuring
    - Masters and alternate masters
4. Lecture Outline  
Week 1 - Use of combinations of navigational aids in maintaining position on fishing grounds, avoiding hangs and obstructions, effects of tide on vessel, vessel modifications affecting turning ability,

trawl effects on navigating and maneuvering.

Week 2 - Type of gear, adjustments to trawl doors, nets, warp length, ground cables, tickler chains, etc., used on all the different bottom compositions.

Week 3 - Problems encountered fishing in areas with other vessels, radar sightings, practical maneuvering procedures, fish location through fleet communication, effects of fleet fishing effort.

Week 4 - Handling of problems while trawling, emergency measures, safety considerations, vessel capabilities, gear modification; methods of avoiding problems.

Week 5 - Determination of fishing effort using all the variables such as fish prices, fishing effort; length of trip, evaluating the market, influence and examples of specialized fishing ports.

Week 6 - Cost of operating a vessel, examples of trip expenses, crew expenses, lay systems, payroll deductions, effects of depreciation, other fixed expenses applying to vessel, insurance allocation.

Week 7 - Developing a model of daily cost of operation using all the normal expenses. Breakdown of model for purposes of evaluating individual tows or catches.

Week 8 - Explanation and analysis of the statement of income and expense and the balance sheet. Benefits of investment credits and method of determination. General journal entries and coding systems.

Weeks 9,10 - Detailed study of the New England fishing area from George's Banks to Cape Hatteras including types of bottom, wrecks, tide considerations, ports available, and specific tows in clear areas. Study is designed to bring to the student the depth of knowledge necessary to fish an area successfully.

Weeks 11,12 - Detailed study of fish migration patterns from George's Bank to Hatteras. Includes all common fish species, preferred fishing gear used in each case, shelf life and storage, price structure, and marketability.

Week 13,14 - The steps necessary to carry out the purchase of a vessel through to the time of actual operation.

#### 5. Laboratory Projects

Weeks 1-8 - Actual operation of a commercial vessel including all phases of operation during an eight to ten hour day. First eight weeks allow for each student to carry out all the assignments.

Assignments - Captain must handle vessel in harbor, trip to the grounds, actual fishing operation in area specified by instructor, supervise crew, guarantee safety, operate all fishing aids (loran,

depth sounder, radar, fish finder, and radio telephone), and record operations in the log of the vessel.

Mate must assist captain in all the above with the primary function of supervising the deck operations.

Engineer must check out engine and all equipment on board, start and operate all systems during daily operation. Repair and maintain as required. Carry out additional duties on deck.

Cook must provide at least two meals, cooked on board, maintenance of cooking equipment, and maintain condition of kitchen area.

Deckhands operate all deck gear, handle fishing equipment, maintain nets; separate, wash, ice, and unload fish.

Weeks 9-14 - A repeat of the above with more difficult fishing areas and with little or no assistance from the instructor other than in matters of safety to the vessel and students. Students change job assignments on the half day, passing on the fishing assignment at the time of relief. In the event of unfavorable weather, students may be required to construct, rebuild, and maintain fishing gear or carry out maintenance projects on the vessel

6. Textbooks - None available.
7. Handouts (duplicated material)
  - a. Nine handouts on wrecks and hangs from George's Banks to Cape Hatteras.
  - b. Net plan for lobster trawl.
  - c. Net plan modifications for fish species discussed.
  - d. Ground cable length versus trawl wire length chart.
8. References

U.S. Master Tax Guide published by Commerce Clearing House, Inc., Chicago, Ill.
9. Equipment List
  - a. Commercial type fishing vessel of 60 feet.
  - b. Complete line of navigation equipment and radio equipment (loran, depth sounder, fishscope, white line recorder, radar, radio telephone).
  - c. Safety equipment including inflatable life raft, life jackets, flares, life ring, and adequate fire fighting equipment.
  - d. One complete net with trawl doors, legs, ground cables, trawl wires, and spares where necessary

10. Laboratory Layout

In this case, a vessel of 60 feet. Requirements should include electronic equipment appropriately laid out for use by the individual student captain. Good visibility of the work area on the vessel for purposes of safety. Controls and shutoffs for main engine in at least two stations (main winch and wheelhouse). Adequate engine gauges and alarms systems for purposes of continuous monitoring by students and instructor.

11. Supplies

- a. Complete line of spare parts for engine and deck gear maintenance.
- b. Fuel, lubricating oil and hydraulic oil as required.
- c. Spare twine, twine needles, fish knives (rippers), fish baskets, pickers, shovels, rope replacement, shackles of various sizes and any other items necessary for net repairs and maintenance.
- d. Cooking utensils and kitchen materials adequate to simulate conditions on board a commercial vessel.

12. Instructor's Teaching Arrangement

Teaching work is divided into one 3-hour lecture period each week, and two 8 to 10 hour laboratory sessions on the training vessel. The class is divided into two equal laboratory sections.

Lecture period covers the enclosed material and includes a discussion of the vessel classes which took place during the week. Questions on the trip are brought up at the time of the vessel class and if there is cause, the questions and solutions are offered during the lecture.

Laboratory period or vessel class allows the students to carry out the fishing procedures offered in the lecture sessions. Since the fishing operations course occurs in the final semester, the student is able to apply most of the knowledge acquired in his other subjects during the previous semesters of study.

13. Method of Grading

Performance in vessel classes	50%
Two-chart assignment on plotting wrecks and hangs	20%
One term paper on specific fishery evaluation	20%
Final examination	10%

REN 135 - FISHERIES ECONOMICS

1. Credits: 5 Lecture hours: 5  
Instructor: Holmsen
2. Description  
Analysis of supply and demand for fish and fishery products. Costs and returns in harvesting and processing. Crew remuneration systems. Fisheries policy and management.
3. Subject Outline  
This service course is not a traditional economics course, but is specifically designed for the students in the fisheries program. Because this is the only social science course required by these students, this course is much broader and goes less in depth than a standard course in the principles of micro-economics. The course is less theoretical and more applied. After five weeks of economic principles (a - f below), it deals with various economic and business issues related to the fishing industry.
  - a. The task of the market system
    - How the market works
    - The production-possibility curve
    - The factors of production
  - b. The market for goods
    - Behavior and prices
    - The conditions of supply and demand
    - Marginal utility
    - Quantities and schedules
    - Individual and collective demand
    - Balancing supply and demand
    - The equilibrium price and its function
    - The role of competition
    - Price and allocation
    - Price versus nonprice rationing
    - Shortage and surplus
  - c. The market in movement
    - Price changes
    - Elasticities: Price elasticity of supply and demand, cross elasticities, income/consumption and income expenditure elasticities.
    - Elasticities, expenditure and receipts
    - Substitution and demand
    - Stability and instability, unstable situations
    - Destabilizing expectation
    - Predictive and normative price theory
  - d. The market for goods
    - Distribution of income
    - The supply curves of factors

- The supply curve of labor
- Elasticities and mobility
- Time and technical specificity
- Quasi rent
- Supply curves and prices
- The demand for factors of production
- Comparative earnings and cause of income disparity
- Entrepreneurial demand
- e. The firm in the factor market
  - The problem of scale
  - The factor mix
  - Increasing and diminishing returns
  - The law of variable proportion
  - Marginal revenue and marginal costs
  - Productivity and profit
  - Factor pricing
  - The market solution to distribution
- f. The equilibrium of the firm
  - Fixed and variable costs
  - Costs per unit
  - Average and marginal cost
  - Average and marginal revenue
  - The firm and the industry
  - Long-run equilibrium
  - Profits and equilibrium
  - The competitive environment
  - Price competition defined
  - Competition in fact and theory
- g. The world fisheries
  - Production and estimated potential
  - Utilization, trends
  - Consumption
  - International trade
- h. U.S. fisheries
  - Production and estimated potential
  - Geographic and biological factors
  - Structure of the major fisheries
  - Utilization trends
  - Consumption
- i. The New England fishery
  - Production and outlook for various species
  - The operation of the Division of Conservation,  
State of Rhode Island
  - Management and enforcement
- j. Price determination in the fishing industry
  - Auction system
  - Fixed pricing
  - Price leadership
  - Sales on consignment
  - Factors affecting prices of food fish, lobster  
and fish meal

- k. Lay systems (remuneration methods) in the fishing industry
    - Theory of risk
    - Clear lay and broken lays
    - Labor union contracts
    - Effect of lay system on investment decisions and ownership patterns
  - l. Cost structure for fishing vessels
    - Breakdown of cost for representative vessel categories
    - Computation of crew share
    - Computation of return on assets and on net worth
    - Factors affecting return to labor and capital
  - m. Co-operatives
    - Principles of co-operatives
    - Supply co-ops, marketing co-ops, bargaining co-ops, and production co-ops
    - The functions of co-operatives
    - Script and its use
    - Why co-ops fail or succeed
  - n. Insurance
    - Purpose and use of insurance
    - Hull and hull war risk
    - P&I, and P&I war risk
    - Harbor workers and longshoremen
    - Workmen's compensation
  - o. Vessel finance, conditions and terms
    - Commercial banks
    - Fisheries Loan Fund
    - Fishing Vessel Mortgage Insurance
    - Construction cost differential payments
    - Small Business Administration
    - Capital Construction Fund
  - p. Theory of fisheries management
    - The Shaeffer model and the maximum sustainable yield concept
    - Maximization of economic rent from a fishery
    - Effect on fishing pressure from price changes and changes in technology
  - q. International fisheries agreements
    - Example of successful and unsuccessful management program
    - Problems of overcapitalization
    - International Convention for Northwest Atlantic Fisheries
    - Yellowtail flounder and haddock agreements
    - Bilateral agreements with Russia and Poland
4. References and Additional Reading Material  
 The following published in whole or in part:
- a. Understanding Micro-economics, R.L. Heilbroner.



- b. The Commonwealth in Ocean Fisheries, R.T. Christy and A. Scott.
- c. "Economics of the Small Trawler Fleet", A. Holmsen.
- d. "Management of the Peruvian Anchovata Resource," A. Holmsen.
- e. "Remuneration Systems and Ownership Patterns in the Fishing Industry and their Relation to Investment Decisions," A. Holmsen.

In addition, a number of statistical publications from the National Marine Fisheries Service, booklets on finance programs, labor union contracts and various unpublished material by the instructor and his colleagues.

5. Outside Speakers

- a. Representative from Department of Natural Resources, State of Rhode Island.
- b. Representative from the insurance industry.

6. Field Trips

- a. Half-day field trip to Point Judith to see:
  - Operation of a marketing co-op
  - Operation of a supply shore
  - Operation of a fish meal plant
  - Operation of a wholesale lobster business
- b. Full-day field trip to New Bedford, Mass., to:
  - Observe fish auction
  - Have seminar with New Bedford Fishermen's Union
  - Have seminar with New Bedford Seafood Dealers Assn.
  - See filleting plants for flounders

APPENDIX H  
SAMPLES OF FINAL EXAMINATION PAPERS ..

FIS 013 - SHIPBOARD WORK I

Answer all the questions. Time allowed: 1-1/2 hours.

PART A

1. a. List the flares normally carried aboard "Gail Ann" for daytime and nighttime use.  
b. What signal do daytime and nighttime flares make?
2. a. How many liferafts are carried aboard "Gail Ann"?  
b. How many persons is each certified to hold?  
c. Describe the procedure for launching a life-raft over the side.
3. Explain the principle and action of the man-overboard float attached to the lifering.
4. Describe the standard man-overboard procedure from the time an alarm is given.
5. a. Describe the fire protection and extinguishing equipment fitted in the engine room of "Gail Ann".  
b. List the number, type and position of portable fire extinguishers aboard "Gail Ann". State the type of fire for which each should be used.
6. a. List the lights to be shown by "Gail Ann" while steaming at night or in restricted visibility. Include details of color and extent of visibility.  
b. List the lights to be shown by "Gail Ann" while trawling at night or in restricted visibility.
7. State the actions to be taken in the event of visibility becoming restricted to less than half a mile.
8. State the fog signals to be sounded on the siren while steaming, and while trawling.
9. When entering Wickford Harbor, state the color of the buoys to port and to starboard.
10. "Gail Ann" is moored at her dock with bow upstream. Wind is from the north at 15 knots, and it is three hours after low water. Describe how to leave the dock. Make sure you show the correct use of the spring and a track of the vessel on a sketch.
11. "Gail Ann" is coming into harbor; the wind is from the north at 15 knots, and it is one hour after

279/280

- high water. Describe, with the aid of a sketch, the procedure to bring the vessel alongside at her dock. Show the track while maneuvering.
12. On a sketch, show the correct layout of mooring lines for "Gail Ann" at her berth.
  13.
    - a. State the VHF radio channel for contacting the Wickford base.
    - b. State other VHF channels of possible use.
  14. Should it prove impossible to contact the Wickford base in the event of an emergency, detail the procedure to be followed. Include details of frequencies used.
  15.
    - a. Determine the compass course to steer in order to make good a chart course of  $087^{\circ}$  true. Assume variation is  $14^{\circ}$ W, and deviation for this course is  $4^{\circ}$ E.
    - b. Determine the compass course to steer in order to make good a chart course of  $267^{\circ}$ T. Assume variation is  $14^{\circ}$ W, and deviation is  $12^{\circ}$ W.
  16. List the pre-start checks for the main engine aboard "Gail Ann".
  17. List the pre-voyage checks for the hydraulic system aboard "Gail Ann".

#### PART B

1. Describe the correct way to thread a twine needle.
2. There are four things you must know before you can mend a net, what are they?
3. Can a hole with five 3-leggers in it be mended properly? Explain.
4. Describe how 3-leggers are eliminated.
5. Is it true that you always tie a knife to your belt?
6. What kind of hitches are used to put on yorkings or latches?
7. What are the meshes called on the edge of a hammock?
8. What is the name given to two meshes taken up as one?
9. When is the only time you can go to a sider when mending a net?

10. After reaching a sider, what do you do next?

FIS 014 - SHIPBOARD WORK II

Answer all the questions. Time allowed: 2 hours.

PART I - All these questions apply to the operation of "Gail Ann" in Narragansett Bay

1. Describe the procedure for launching a life raft carried aboard "Gail Ann".
2. List the VHF channels which are available aboard "Gail Ann". To which channel should this instrument normally be set during operation?
3. In case of distress, outline the procedure to be followed if unable to contact the Wickford Laboratory.
4. Describe the fire protection system fitted for the engine room in "Gail Ann". Include details of how it operates and precautions to be taken in its use.
5. State the normal operating range for main engine oil pressure, drive gear pressure, engine temperature.
6. Describe the starting procedure for the main and auxiliary engines aboard "Gail Ann". Include details of the pre-start and operating checks.
7. "Gail Ann" is at the Wockford dock, preparing to leave, bow upstream. It is one hour after high water and the wind is south at approx. 15 knots. Sketch and describe the procedure for leaving the dock to leave harbor.
8. State the Sound Signals to be used aboard "Gail Ann" during fog or reduced visibility--
  - a. While steaming
  - b. When stopped
  - c. When anchored
  - d. When fishing
9. Why is it important to ensure the Log Book is complete and accurate?
10. Describe the correct manner to pump bilges using the main pump system. What additional pumping arrangements are installed?

11. Determine the correct compass course to steer for the following chart courses. You may assume variation is  $14^{\circ}\text{W}$ , deviation as noted in each case:
  - a.  $010^{\circ}\text{T}$  (Dev.  $8^{\circ}\text{W}$ )
  - b.  $120^{\circ}\text{T}$  (Dev.  $4^{\circ}\text{E}$ )
  - c.  $341^{\circ}\text{T}$  (Dev.  $10^{\circ}\text{W}$ )
  - d. East (Dev.  $2^{\circ}\text{E}$ )
12. "Gail Ann" is preparing to come alongside the Wickford berth; it is 2 hours after low water, the wind is north at 25 knots and gusting. Sketch and describe the correct way to dock the vessel. Include a sketch showing the correct way to lay out mooring lines at spring tides.
13. With the aid of sketches, describe the operation of obtaining a position fix using the radar and variable range marker. Why is it important to choose carefully the land points or objects used to obtain the position fix?
14. Describe the operation of setting and hauling the bottom trawl during a class session aboard "Gail Ann", using the net drum arrangement. Mention the use of engine revolutions and the hydraulics as appropriate.

#### PART II

For the "stern trawling with quarter ropes" method:

- 1) Make neat sketches showing the fishing arrangement aboard "Gail Ann". Ensure that the sketches are complete and accurate.
- 2) Describe in detail the rigging and operation of the gear; be concise, accurate, complete, and mention precautions necessary to ensure the net sets correctly.

#### FIS 015 - SHIPBOARD WORK III

Answer both questions. Time allowed: 2 hours.

1.
  - a. Draw a diagram indicating the position of the seine skiff and arrows showing the setting of the seine net from the "Gail Ann" when the wind direction is northwest.
  - b. What are the duties of the skiff man?
  - c. With a crew of five men, explain each man's duty when setting and hauling the seine.

- d. What is the purpose of the purse line?
  - e. The long rope on the wing end of the net must be there, but not necessarily used every time the seine is set. What is it called and when does it become necessary to use it?
2.
    - a. When dragging on the "Gail Ann" using the quarter ropes, what is the proper procedure for setting the net? Explain in full detail including the hook-up of the doors.
    - b. The bull rope will sometimes foul around the codend or bellies. What causes this to happen and how can it be prevented?
    - c. With a four-man crew, explain each man's job when hauling back the net.
    - d. What is the proper procedure when the net becomes foul in the bottom?
    - e. When the winch fails, what can be done to save the gear that is being towed?

FIS 110 - MARINE TECHNOLOGY

Answer all the questions. Time allowed: 3 hours.

1. A fairlead block for a gypsy head is located according to the diagram. Determine the force on the shackle holding the snatch block if the tension in the line is 1,000 lbs. (assume the lines and the block lie in the vertical plane).

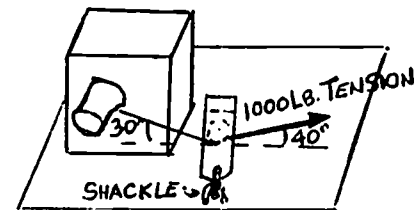

2. Determine the sum of the moments about Point A for the forces shown.

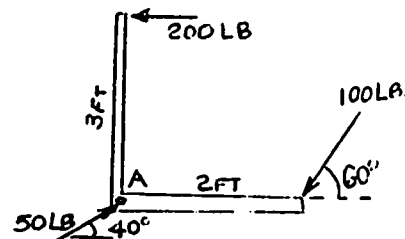

3. A stabilizer boom has the geometry shown. Determine the tension in the cable AB and the reactions on the pin at C i.e.  $C_x$  and  $C_y$ . The boom weighs 400 lbs. which may be considered to act at its center.

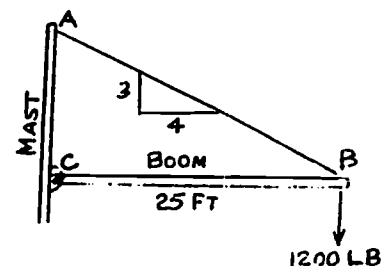

4. For the steel rod in tension, determine the following: (a) stress in the rod, (b) strain in the rod, (c) the total elongation. The cross section area is 2 sq.in., and  $Y_{\text{steel}}$  is  $30 \times 10^6$  lb/in<sup>2</sup>.



5. A 3 HP pump is delivering sea water to a tank at a discharge height of 10 ft. Assume the pump to be 80% efficient. How many ft<sup>3</sup> per minute will the pump deliver? (1 ft<sup>3</sup> weighs 64 lbs.)
6. A seagull is flying slowly at an altitude of 100 ft. If the gull inadvertently discharges over the people waiting for the Block Island ferry, what is the velocity of impact on the unfortunate person in the path of the discharge?
7. A large tank with sea water is filled to a depth of 12 ft. If there is a 2 inch valved pipe in the bottom, what is the volume discharge rate in ft<sup>3</sup>/sec when the drain valve is open? (Density of sea water is 2.0 slug/ft<sup>3</sup>.)

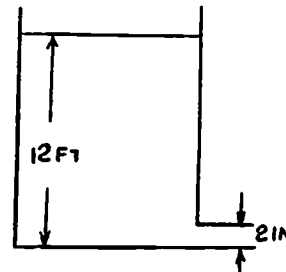

8. Calculate the heat transfer in btu/hr of a fish hold under the following conditions: Surface area of hold is 2,000 ft<sup>2</sup>. The hold is constructed of 2 inches of wood and 4 inches of styrofoam insulation. Temperature inside is 38°F, temperature outside is 88°F.  $k_{\text{wood}}$  is 0.10 btu/hr.ft.°F.  $k_{\text{styrofoam}}$  is 0.015 btu/hr.ft.°F.

### FIS 118 - INTRODUCTION TO COMMERCIAL FISHERIES

Time allowed: 3 hours.

PART A - Answer all the questions.

1. Relate the problem of population assessment to the management of the quahog resources of the State of Rhode Island.
2. What factors account for the age distribution of quahogs found in the West Passage of Narragansett Bay in the area of the Jamestown Bridge?

3. Discuss the longevity and reproduction cycle of the bay scallop.
4. What factors are involved in determining the catchability of herring with midwater trawling gear?
5. What two families of fish make up the bulk of the world's landings?
6. Under what conditions can demersal species be harvested for the production of fish meal and oil?
7. Compare the fishing techniques used for catching alewife and menhaden in the Chesapeake Bay.
8. Compare the relative importance of the cod and haddock fisheries on a world-wide basis.
9. What factors are responsible for the presence of "deserts" in the ocean?
10. What do you think accounts for the cyclic variation in the abundance of herring in the North Atlantic?
11. What part does the reproductive age of fish have to do with their ability to withstand intensive fishing pressure?
12. Give four examples of anadromous fish and discuss the life cycle of one.
13. Discuss the effect of fishing pressure on the size distribution of lobsters taken in the inshore pot fishery.
14. What three species account for the bulk of the shrimp taken in the Gulf of Mexico?
15. Compare the relative size of the stone crab and blue crab fisheries in Florida.
16. Discuss in general terms areas outside of the United States where shrimp are being taken in commercial quantities.
17. What behavioral characteristics reduce the availability of thread herring to commercial fishing gear?
18. In what area are the largest concentrations of fish in U.S. coastal waters located?



19. What factors mitigated against wider participation in the menhaden fishery?
20. What commercial marine fishery can be entered with a minimal investment? Discuss the factors which restrict the development of the fishery.

PART B - Answer questions 1 and two other questions.

1.
  - a. State the main factors to be considered when choosing the fishing method and gear to be used in a particular area.
  - b. State the two principal types of encircling gear used in the world's commercial fisheries and explain how they differ in technique and gear.
  - c. Make a neat sketch showing a standard bottom trawl fishing on the sea bed. Show the net rigged for quarter ropes and include details of the Kelly's eye and stopper arrangement.
2.
  - a. Make a neat sketch showing a profile and deck layout for a vessel about 90 ft. in length, rigged as a stern ramp trawler.
  - b. Describe, briefly, the operation of the vessel layout you have drawn.
3.
  - a. Sketch neatly a double rig vessel suitable for the Gulf of Mexico Shrimp fishery. State a suitable size for such a vessel.
  - b. Explain briefly how European double rig trawlers differ from those used in Gulf Shrimp fishery. Include a sketch showing the special safety arrangement for the warp leads used aboard European vessels.
4.
  - a. State the three common operational arrangements found aboard offshore dredging vessels.
  - b. Describe one of the operational methods in detail, illustrating your answer with neat sketches.
5.
  - a. List the principal methods of purse seining.
  - b. Describe one of the methods in detail, using sketches to illustrate your answer.
6.
  - a. Make a neat sketch of a vessel, with wheelhouse aft, rigged for seine net fishing. Note the deck equipment necessary for this operation.
  - b. Describe, with the aid of sketches, the operation of "fly-dragging."

FIS 121 - FISHING GEAR I

Answer all the questions. Time allowed: 1 hour.

1. There are four things to know before you can mend twine. What are they?
2. Can a hole that has an uneven number of three leggers be mended properly?
3. How many quarters are there in a net? Where are they?
4. What are siders?
5. Can you go from one side to another on the same side of a hole? If not, explain why.
6. How do you join a wing to a belly?
7. When mending a hole, where would you find pick-ups?
8. How many parts of twine make up a net? Name them.
9. On side trawlers, what are the ropes called that lift the net on board?
10. Name the ropes to which the ends of the wings are attached.
11. What are the advantages of having the head rope in three pieces?
12. Roller chains are made of 3, 5 or 7 links; why?
13. Describe how to stop an odd-linked chain to the hanging line.
14. Name the rope that comes from the cod-end to the headrope.
15. Name the rope that goes around the cod-end through the beackets. What is its use?
16. The quarter ropes go through two rings on the head-rope. What are they called?
17. Is it true that the net is hauled back on the lee side?
18. Name the line on which the dog's ears are hung.

19. How many dog's ears are there on a top wing?
20. Is it true that the bunt end of a wing is the narrow end?
21. What are the dimensions of the 52 by 72 square?
22. What is the common name for the Yankee 35 net?
23. Describe the two methods used for putting on floats.
24. Is it true that you can remove the knot from a sider?
25. Is it true that your knife should be tied to your belt?
26. Why are roller wires made in several pieces?
27. Is it true that when using your jackknife to cut rope, you should always cut toward yourself?

### FIS 122 - FISHING GEAR II

Answer both questions. Time allowed: 3 hours.

i. Midwater Trawls

Discuss the following problems as they relate to midwater trawling for herring:

- a. The behavior patterns of herring which affect the design of the trawl.
- b. The various design features, twine, etc., which are common in most midwater trawls as a result of the study of behavior patterns.
- c. The problems of controlling a midwater trawl, including the methods and/or means of adjusting the depth of the trawl in midwater, the effect of tide, and the importance of electronic monitoring.
- d. The design features of midwater trawl nets that can be used to assist in controlling the position of the net in midwater and those design features which assist in shortening the reaction time of the trawl.

II. Seines

- a. Discuss four design features that can increase the sinking speed of a seine.
- b. Discuss the considerations that must be taken into account by the operator when setting a seine from a single boat.

- c. Draw the general layout of two of the following three seines: Two Boat Menhaden Seine, Salmon Seine, and Hybrid Tuna Seine.
- d. What are the major considerations that have led to the design of the seines in each case of the two seines you described in Question C?

FIS 131 - SEAMANSHIP

Answer all the questions. Time allowed: 3 hours.

1. Explain your various actions from the time of receiving a distress call to the time rescue is effected.
2. A fire has broken out in a crewman's cabin forward, the door is locked; describe how you would deal with this situation considering safety of vessel and crew.
3. Explain why synthetic fiber rope is replacing rope of natural fibers for many shipboard uses; list some exceptions to this trend and give reasons.
4. What would a stress of half a ton applied to the hauling part of a two-fold purchase lift when rove to advantage? What size wire rope of 6 x 25 structure would be required for this tackle?
5. List the signals that may be used by a vessel in distress and requiring assistance as stated in the international regulations for preventing collisions at sea. Could a vessel not under command make use of any of these signals to attract attention?
6. Describe how the principle of cathodic protection is applied in combatting corrosion near the stern of a vessel (a diagram may be helpful). Why wouldn't you use antifouling paint as an anti-corrosive?
7. Illustrate with the aid of diagrams how you would turn a vessel "short round" in a narrow channel. Justify the direction that you turn considering your vessel to be single screw right handed.
8.
  - a. Box the compass in quarter points from S x W to SW x W.
  - b. Illustrate what is meant by 3 points on port quarter.

- c. Show the trim condition: "2 feet by the stern."
9. Sketch a snatch block, indicate its component parts and list its uses.
  10. Your vessel has become badly "iced up" and it may be necessary to beach her in order to save boat and crew. Explain what preparations you would make to ground the vessel and how you would later refloat her.

FIS 141 - MARINE ENGINEERING TECHNOLOGY I

Time allowed: 3 hours.

PART I. Basic Engineering Questions.  
(Answer any five questions.)

1. Explain torque as it applies to a diesel.
2. Explain the term "compression ratio."
3. Explain what is meant by the "delay period."
4. What is the effect on the diesel if the delay period is shortened by increasing the compression ratio?
5. What part does "turbulence" play in the combustion process?
6. What is "Friction H.P."?
7. What are the major benefits of the piston crown design adopted by G.M.?
8. The problem of vibration in an engine is solved by the following means. Explain each.
  - a. vibration damper
  - b. counterbalance shaft
  - c. counterweights on the crankshaft

PART II. Fuel Systems.

(Answer any four questions.)

1. Explain the theory of the port and helix system as it applies to either the Caterpillar or G.M. engine.
2. What is meant by "retraction volume" as it applies to the delivery check valve of a "Bosch" system?
3. How does the "open" type nozzle work in a Cummins P.T. system?

4. The most common type nozzle is a differential needle valve type. Diagram and explain its principle of operation.
5. Which of the following systems require timing to the engine? How is the timing accomplished in each case? Caterpillar, Cummins, G.M.

PART III. Lube oil, fuel oil, and cooling systems.  
(Answer any three questions.)

1. Diagram the path the lube oil must take to supply the engine with proper lubrication. Start with the lube oil pump in the base. Label the parts and direction of flow.
2. Most lube oil filters make use of a "fuel flow" system. Explain how this system works and why it is used.
3. Describe how the lube oil cools the pistons in most engines.
4. Fuel oil tanks, especially in boats, are prone to have trouble with water in the fuel. What are some of the precautionary measures taken to eliminate this problem?
5. Many boats make use of a basic salt water-fresh water system using a heat exchanger. Use a schematic diagram to explain the system.

PART IV. The turbocharger--answer the following questions as they relate to a four-cycle turbocharged engine. (Answer any four questions.)

1. Draw a pressure diagram of the various strokes of a turbocharged four-cycle engine.
2. Describe what happens as far as valve timing on each of the four strokes.
3. Why is the valve overlap greater in a turbocharged engine as opposed to a naturally aspirated engine?
4. Using a schematic diagram, show the location of the aftercooler in the air system. In addition, explain the function of the aftercooler.
5. What is the difference between using "jacket" water or "raw" water in the aftercooler?
6. Describe how a turbocharger works using the "constant pressure" system.

PART V. Engine governors

(Answer any two questions.)

1. Most governors operate on the same basic principle. Using a governor system from one of the engines of which you are more familiar, G.M. or Caterpillar, diagram and explain the basic system.
2. If we engage the marine gear on a diesel there would be some adjustment made by the governor. What actually happens? Include the fuel system adjustment.
3. Explain the part the governor plays in the operation of the Cummins fuel pump.

PART VI. Starting systems

(Answer both questions.)

1. Describe how an engine is turned over using an electric starter. Include the actual starting mechanism.
2. Name and explain three of the innovations used to enable diesels to start more easily in cold weather

FIS 142 - MARINE ENGINEERING TECHNOLOGY II

Answer all questions. Time allowed: 3 hours.  
Use data book to solve problems.

1. Cylinder Problem

We are planning to use two cylinders to raise and lower a gantry on a small stern trawler. We have calculated the total load and the angles involved and decided that we had to meet the following requirements:

Load - 21,000 lb. each piston  
Distance of travel - 70"  
1000 PSI - 25% safety factor  
Time - 3/4 minute for the extension

- Find -
- a) Piston size
  - b) Rod size
  - c) Length of stroke
  - d) Size Pump (for 2 cylinders)
  - e) Size Motor to drive pump
  - f) Pipe size required (pressure & return)
  - g) Reservoir size
  - h) Inlet Piping
  - i) Control Valve type & size
  - j) Pressure relief valve size and capacity
  - k) Filter - return & suction specifications or requirements

2. Marco W1170 Single Drum Trawl Winch

Given: 40" dia. drum (1-1/2" flange remaining)  
210 ft. per min. full drum  
10,000 lb. line pull  
Use 25% safety factor

Find: R.P.M. and H.P. required

If we used 2000 PSI for the system, how many GPM would we require?

3. Hydraulic Purse Winch

Given: gypsy dia. 12"  
line speed desired 185' per min.  
hydraulic system available 75GPM @ 200 PSI

Find: Line pull in lbs.

4. Describe the operation of an axial piston pump and a balanced vane pump.
5. Design a complete circuit using ASA symbols which would incorporate a series of three hydraulic cylinders requiring 5 G.P.M. at 1000 PSI and a single reversible hydraulic motor requiring 35 G.P.M. at 2000 PSI. Choose the type of valves which would be needed, the appropriate pipe sizes and specifications (extra heavy, etc.), reservoir size, relief valves, return and suction filters, and when laying out the drawing, position a heat exchanger in the system.
6. Calculate the following, given the data below:
- Effective area of push (blind) side of cylinder in square inches.
  - Effective area of pull (rod side) in square inches.
  - Volume of oil needed to extend cylinder (1 full stroke) in cubic inches.
  - Volume of oil needed to retract cylinder (1 full stroke) in cubic inches.
  - Speed in inches per minute when cylinder is extending.
  - Speed in inches per minute when cylinder is retracting.
  - Time (in seconds) it takes to extend.
  - Time (in seconds) it takes to retract.
  - Theoretical thrust developed on the push stroke.
  - Theoretical thrust developed on the pull stroke.
  - Actual thrust developed on the push stroke.
  - Actual thrust developed on the pull stroke.



Piston diameter . . . . . 4"  
 Piston stroke . . . . . 46"  
 Piston Rod diameter . . . . . 1 3/4"  
 G.P.M. of Pump . . . . . 11 G.P.M.  
 System Pressure . . . . . 750 P.S.I.

7. Answer true or false to the following statements:
- a. A needle valve should never be used in a hydraulic circuit.
  - b. A check valve allows free flow in one direction and stops the flow in the opposite direction.
  - c. Pressure relief valves are not necessary in a circuit using an open center 4-way valve.
  - d. Most hydraulic valves can be installed without concern over the direction of flow.
  - e. Button bleeders are used primarily to control 4-way hydraulic valves.
  - f. Solenoid controlled valves of large size make use of the system pressure to move the spools.
  - g. A detent is a mechanical arrangement to hold the valve spool in the desired position against drift.
  - h. There is no pressure loss experienced when using tandem center valves regardless of how many are used in the series.
  - j. Circuit drawings using USASI symbols are usually made with the directional control valves in this activated position.
  - k. A 5 P.S.I. pressure difference between inlet and outlet is a necessary part of a 2-way normally closed solenoid valve operation.

FIS 151 - FISH TECHNOLOGY

Answer all the questions. Time allowed: 3 hours.

1. Compare the keeping time and factors related to the deterioration in quality of fresh and smoked whiting.
2. What is an "iron chink?" Describe the significance of canning as a method of preservation in the fishery with which it is associated.
3. What problems would you anticipate if food fish, for example salmon, are held in refrigerated sea water for periods in excess of 10 days?
4. What factors account for the increased storage life of fish held at 29°F when compared with fish held at 32°F?

5. Lobsters are normally held in live wells in off-shore trawlers. What conditions determine the length of time that lobsters can be held?
6. Compare the relative sensitivity of lobsters to changes in pressure and temperature.
7. Pasteurization has been suggested as a pretreatment for eviscerated cod stored in ice during the winter, describe the effect of such a treatment on the Maine shrimp (Pandalus borealis).
8. Black spot in shrimp can be controlled by chemical treatment. What chemical is commonly used for this purpose?
9. In fresh fish the build-up of trimethyl amine is associated with deterioration. What is the source of this compound and what conditions result in its formulation?
10. What effect does the air temperature in the fish hold have on the cooling rate of iced fish?
11. Fish products may become contaminated with different species of bacteria. Compare the significance of a high count of Clostridium botulinum and Pseudomonas fluorescens.
12. Fish meals have been implicated in the transmission of salmonellosis. What kind of bacteria are responsible for this disease?
13. Compare the relative significance of the three causes of deterioration in iced cod fish.
14. Why is it necessary to maintain anaerobic conditions in brine cured herring?
15. In what form was the bulk of the fish protein consumed in the United States in 1968?
16. What conditions make possible the profitable operation of a fish meal factory ship?
17. What factors do you feel are currently holding back the development of a fish protein concentrate industry in the U.S.?
18. What properties of fish oil contribute to its stability and how do these relate to the keeping quality of fatty fish?

19. What changes would you expect to find in dried salted herring after a few weeks storage at room temperature?
20. What effect does temperature have on the rate and nature of oxidation occurring in the lipids of fish?

### FIS 161 - MARINE ELECTRONICS

Answer all the questions. Time allowed: 3 hours.

1. Draw a complete circuit diagram of the wiring system that would be suitable for a 45 foot lobster boat or small dragger. Specify battery voltage, all wire sizes, all fuse sizes and approximate wattage of each load.

Assume vessel is 6-cylinder gas powered. Show circuit diagram of ignition system, charging system, and starting system. Also provide feed for three pieces of electronic equipment.

Suggestion: Sketch a rough block diagram first and rearrange parts if necessary so that your final diagram will compose neatly on one page.

2. Explain the difference between galvanic action and stray current corrosion. Explain why the choice of one ground polarity is better than the other from a corrosion point of view.
3. Draw a diagram of a single cell of a conventional storage battery. Identify and label its parts. Give the chemical composition of the plates and the electrolyte and tell how these chemical compositions change from charge to discharge. Explain the function of a hydrometer and give two typical values of its readings.

Does the freezing point of the electrolyte go down when the hydrometer reading goes up? Explain.

4.
  - a. Describe the performance characteristics of VHF - FM radiotelephony.
  - b. Describe the performance characteristics of MF - AM radiotelephony.
5.
  - a. Calculate the voltage drop from a 12 volt battery in the engine room to a depth recorder in the wheelhouse. The feed wire is #10 duplex. It is 80 feet long and the depth recorder draws 6 Amperes.

- b. How many watts does the recorder draw?
- c. How many watts is wasted in the feed wire?

FIS 171 - VESSEL TECHNOLOGY

Answer all the questions. Time allowed: 3 hours.

1. A 120 ft. side trawler has the following rectangular tank free surfaces:
  - Fuel 2 tanks each 14.0 ft. long by 8.0 ft. wide
  - Fresh Water 1 tank 6.0 ft. long by 13.0 ft. wideAssuming fresh water stores at 36 cu.ft. per ton and fuel stores at 40 cu.ft. per ton, estimate the free surface correction for the vessel loaded to a displacement of 581 tons. In this condition, the solid GM was estimated as 2.37 ft., calculate the GM liquid.
2. State the meaning of the following BHP ratings for diesel engines as specified by Commercial Standard C S 102E-42 of the National Bureau of Standards:
  - a. Maximum power available, or peak output
  - b. Intermittent rating
  - c. Continuous ratingWhich of these ratings would you specify for an engine to be installed aboard a purse seiner?
3.
  - a. For what type of fishing vessel is a Kort nozzle particularly suitable? Explain your answer.
  - b. Discuss the relative merits of fixed and swiveling nozzles.
4. Compare the merits of fitting a controllable pitch propeller versus an Omega clutch system to a trawler.
5. For either a wooden or a steel fishing vessel hull of about 70 or 80 ft. LOA:
  - a. Sketch a structural section, and note the principal scantlings.
  - b. List the pieces of structure which contribute to:
    - 1) Longitudinal strength
    - 2) Transverse strength
6. Discuss the advantages and disadvantages of one of the following as a fishing vessel construction material:
  - a. Ferro cement
  - b. GRP
  - c. Aluminum

7. How will the RPM and available power differ between the towing and passage conditions for a trawler--
  - a. having a propeller selected to provide maximum pull at towing speed?
  - b. having a propeller selected to provide best passage performance?
 Explain your answer in each case.
8. Explain the function of Classification Societies, such as the American Bureau of Shipping (A.B.S.) Discuss the advantages and disadvantages of building a fishing vessel to be classed by a Classification Society.

FIS 181 - NAVIGATION I

Answer all the questions. Time allowed: 3 hours.

1. Describe how you would evaluate the accuracy of a compass on a vessel that you have just joined in a port where no compass adjuster is available. If you are now leaving on a long passage, what limitations would you put on this evaluation and how would you allow for such limitations?
2. Define the following:
  - a. Departure
  - b. Rhumb Line
  - c. Difference of Longitude
  - d. Isogonic Lines
  - e. Small corrections
3. Describe how you would utilize the characteristics of two common chart projections in order to "lay off" the shortest route between two places.
4.
  - a. What is meant by Sextant Index Error?
  - b. Why is the arc of a sextant graduated in degrees which are in fact only half degrees?
5. Calculate the course and distance from  $48^{\circ}12' S$   $178^{\circ}18' E$  to  $52^{\circ}11' S$   $174^{\circ}27' W$  using plane sailing.
6. Find the course and distance from  $7^{\circ}42' N$   $13^{\circ}06' W$  to  $24^{\circ}18' N$   $6^{\circ}02' W$  by mercator sailing.

## FIS 182 - NAVIGATION II

Answer all the questions. Time allowed: 3 hours.

Note: Use diagrams throughout and check your work by alternative methods where possible.

1. What information is provided in the Nautical Almanac concerning the apparent daily and annual behavior of the sun? Why do we require the Mean Astronomical Sun and how do the two suns fit into our time keeping system? What contributions did Johannes Kepler, Pope Gregory XIII and John Harrison make to time-keeping?
2. Define the following with the aid of diagrams:
  - a. A vertical circle
  - b. Second principle of the sextant
  - c. Parallax
  - d. Haversine
  - e. Horizon mirror
3. Calculate the latitude of an observer in longitude  $22^{\circ}15'W$  if the true meridian altitude of the sun was  $57^{\circ}07'$  bearing north of the observer on August 27, 1968. How could you check if the calculated time of noon was correct?
4. On 26 August 1968 the Sun was observed with lower limb one semi-diameter above the visible horizon bearing  $290^{\circ}C$  from D.R. position  $51^{\circ}00'N$   $15^{\circ}00'W$ . If the variation was  $4^{\circ}W$ , state deviation.
5. An observation of the Sun bearing  $270^{\circ}T$  gave an intercept of  $3'$  towards at 1730 hrs. in D.R. position  $32^{\circ}45'N$   $17^{\circ}12'W$ . The vessel then steered  $046^{\circ}C$ , C.E.  $4^{\circ}E$  at 15 kts. until 1930 hrs. when latitude by observation of the pole star was  $33^{\circ}08'N$ . Calculate the observer's longitude at 1930 hrs.
6. On August 26, 1968 at 0930 L.M.T. the sextant altitude of  $\odot$  was  $44^{\circ}9.6'$ . The vessel was in D.R. position  $39^{\circ}30'N$   $71^{\circ}15'W$  and the chronometer which was 12m 13s slow of G.M.T. was reading 13h 55m 16s. Calculate the direction of the position line and a position through which it passes if the observer's H.E. is 16 feet and I.E.  $0.8'$  on the arc. (Use any method of sight reduction.)

## FIS 192 - FISHING OPERATIONS

Answer all the questions. Time allowed: 3 hours.

Note: Read all parts to each question carefully. Be precise. Avoid lengthy answers. Use diagrams as often as you can, rather than a written explanation.

- I. Certain changes can be made to any design bottom trawl to increase its fishing capabilities. Assuming you fished a standard #35 or #36 "framed" net on a vessel of 350 H.P., what would you do to the net to catch the most fish based on the following considerations: number of floats, trim of net, trim of doors, weight of doors, type of sweep, length and type of ground cable and legs, backstraps of doors, twine size of net, tailpiece (if used), cod end, etc.
  1. Fishing for scup in rocky bottom.
  2. Fishing for yellowtail in hard, muddy bottom.
  3. Fishing for butterfish in smooth, muddy bottom with starfish in excessive quantity.
  4. Fishing for flounder in sand lumps.
  5. Fishing for lobster in deep water with irregular, muddy bottom.
  6. Fishing for fluke in hard, sandy bottom.
  
- II. Discuss the following points a vessel captain must consider under the following conditions: Use diagrams!
  1. Passing a vessel while towing with an eastern-style dragger: a) daytime, b) nighttime.
  2. Using the radar while towing in a fleet of boats. (Use some imagination.)
  3. Maintaining a tow while following a loran line using cross bearings on each end of the tow.
  4. How would you determine whether the net was mudding up?
  5. What steps would you take if you had a foul set?
  6. What is the haul-back procedure on an eastern dragger catching large quantities of hake for industrial purposes?
  
- III. The following questions pertain to vessel management and operation:
  1. List at least six considerations in evaluating a tow as it relates to a vessel that is trip fishing.
  2. & 3. The cost of vessel operations is based on the fixed and variable costs of the vessel. Other costs are charged entirely, or in part, to the crew. Using the settlement sheet supplied by the instructor, make out a settlement for: a) a broken 40 lay; b) a clear 40 lay. Complete

the settlement using 5.2% for FICA, 30% for federal tax, 15% of the federal tax for determining the state tax.

Costs to be applied in the settlement sheet: gross stock \$5,525, fuel \$325, ice \$150, lube oil \$35, electronics \$40, food \$150, gloves \$10, Captain's share 10% of boat share, crew of five men.

4. How does depreciation work as a tax benefit to a vessel owner? Note: Begin by defining depreciation in general terms.
5. What is a Statement of Income and Expense? How would it help you in evaluating your own or someone else's vessel operation?



## APPENDIX J

### STUDENT DATA

Data for students in entering classes which have completed the program is given in the following pages. The 1971 entry is not included, as these students have completed only one of the two years work.

Columns 1,2,3, - show students' background

- Column 1 - Veteran status; Y = veteran, N = non veteran
- Column 2 - Previous College experience; Y = some previous college work, N = no previous college work.
- Column 3 - Fishing background; Y = some previous fishing background, N = no previous fisheries connection.

Columns 4,5 - show preparatory experience

- Column 4 - Average of scholastic aptitude test scores
- Column 5 - High school class rank

Columns 6,7,8,9 - show student performance during the program

- Column 6 - Graduate; Y = graduate, N = non graduate
- Column 7 - Level of graduation; 4 = highest distinction, 3 = high distinction, 2 = distinction, 1 = pass.
- Column 8 - Completed two years; Y = student completed two years in the program, N = did not complete two years in the program.
- Column 9 - Withdrew/dismissed; W = student withdrew before completing program, D = student was dismissed for academic failure.

Columns 10,11 - show students' activities after graduating or leaving the program

- Column 10 - Entered fishing industry; Y = entered some phase of the fishing or an associated marine industry, N = did not enter industry, y = entered industry on a part-time basis in conjunction with continuing education.
- Column 11 - Continued education at University of Rhode Island, at another university, a Junior or Community College.

General - Where information is not available under a heading, this is indicated by (-).  
Where a column heading does not apply, this is indicated by (n/a).

1967 STUDENT ENTRY

	1	2	3	4	5	6	7	8	9	10	11
number	veteran	previous college	fishing background	av'ge score aptitude tests	high school class rank	graduate	level of graduation	completed two years	withdrew/dissmised	entered fish. ind.	continued education
1	Y	Y	Y	650	-	Y	4	Y	n/a	Y	N
2	N	N	Y	390	$\frac{2}{4}$	Y	1	Y	n/a	Y	N
3	N	N	N	-	$\frac{362}{687}$	N	n/a	N	W	N	Y
4	N	N	N	470	$\frac{181}{207}$	N	n/a	N	W	N	Y
5	Y	N	N	435	$\frac{201}{279}$	N	n/a	N	W	Y	N
6	N	N	N	280	$\frac{192}{197}$	Y	1	Y	n/a	Y	N
7	N	N	Y	-	-	N	n/a	N	W	N	N
8	N	N	N	420	$\frac{17}{23}$	N	n/a	N	W	Y	N
9	Y	Y	Y	650	$\frac{11}{50}$	N	n/a	Y	n/a	Y	N
10	N	N	N	450	$\frac{34}{77}$	Y	1	Y	n/a	Y	N
11	Y	Y	Y	B.S. degree		Y	4	Y	n/a	Y	N
12	Y	Y	Y	-	$\frac{19}{44}$	Y	2	Y	n/a	Y	N
13	Y	N	Y	400	-	N	n/a	N	D	Y	N
14	Y	N	N	520	$\frac{47}{89}$	N	n/a	N	W	Y	N
15	N	N	N	460	-	Y	3	Y	n/a	Y	Y
16	Y	N	N	580	$\frac{38}{48}$	Y	1	Y	n/a	Y	N
17	N	N	Y	380	$\frac{140}{244}$	Y	1	Y	n/a	Y	N
18	N	N	Y	360	$\frac{148}{190}$	Y	1	Y	n/a	Y	N
19	N	N	Y	480	$\frac{55}{169}$	N	n/a	N	D	Y	N
20	N	N	Y	450	$\frac{117}{205}$	N	n/a	Y	n/a	Y	N

1967 STUDENT ENTRY (cont.)

	1	2	3	4	5	6	7	8	9	10	11
number	veteran	previous college	fishing background	av'ge score aptitude tests	high school class rank	graduate	level of graduation	completed two years	withdrew/dissmised	entered fish. ind.	continued education
21	N	N	N	-	$\frac{140}{264}$	N	n/a	N	D	N	N
22	N	Y	Y	-	$\frac{165}{215}$	Y	1	Y	n/a	Y	N
23	N	N	N	275	$\frac{6}{6}$	N	n/a	N	D	N	Y
24	N	N	N	440	$\frac{571}{730}$	N	n/a	N	D	N	Y
25	N	N	N	-	$\frac{4}{6}$	N	n/a	N	D	N	Y
26	N	N	Y	410	$\frac{158}{216}$	N	n/a	N	W	N	Y

1968 STUDENT ENTRY

1	N	Y	Y	-	$\frac{81}{174}$	Y	3	Y	n/a	Y	N
2	Y	Y	Y	680	$\frac{25}{500}$	Y	4	Y	n/a	y	Y
3	Y	N	Y	630	$\frac{112}{113}$	Y	1	Y	n/a	Y	N
4	N	Y	Y	-	-	Y	2	Y	n/a	Y	N
5	N	Y	N	-	$\frac{250}{529}$	Y	1	Y	n/a	Y	N
6	N	N	N	290	$\frac{205}{233}$	Y	1	Y	n/a	Y	N
7	N	Y	Y	510	$\frac{293}{367}$	Y	3	Y	n/a	Y	N
8	N	N	Y	510	$\frac{52}{64}$	Y	1	Y	n/a	Y	N
9	Y	Y	Y	-	-	Y	1	Y	n/a	Y	N
10	N	N	Y	395	$\frac{155}{214}$	Y	1	Y	n/a	Y	N
11	N	N	N	-	-	N	n/a	N	W	N	Y
12	N	Y	Y	640	-	Y	1	Y	n/a	y	Y

1968 STUDENT ENTRY (cont.)

	1	2	3	4	5	6	7	8	9	10	11
number	veteran	previous college	fishing background	av'ge score aptitude tests	high school class rank	graduate	level of graduation	completed two years	withdrew/dissmised	entered fish. ind.	continued education
13	N	Y	Y	550	-	N	n/a	N	W	N	Y
14	N	Y	Y	615	$\frac{70}{800}$	Y	3	Y	n/a	Y	N
15	N	Y	N	-	-	N	n/a	N	W	N	N
16	N	N	Y	340	$\frac{37}{105}$	Y	1	Y	n/a	Y	N
17	N	N	Y	370	$\frac{24}{52}$	Y	1	Y	n/a	Y	N
18	Y	N	N	-	$\frac{388}{605}$	N	n/a	N	W	N	N
19	N	N	N	420	$\frac{14}{329}$	N	n/a	N	W	N	N
20	Y	Y	N	-	-	N	n/a	N	W	N	Y
21	N	Y	N	490	$\frac{370}{554}$	N	n/a	N	W	N	N
22	N	N	Y	405	$\frac{139}{214}$	N	n/a	N	W	N	N
23	N	N	Y	373	$\frac{55}{62}$	N	n/a	N	W	Y	N

1969 STUDENT ENTRY

1	Y	N	Y	-	$\frac{112}{465}$	Y	1	Y	n/a	Y	N
2	N	Y	Y	-	-	Y	1	Y	n/a	N	Y
3	N	Y	N	-	$\frac{74}{101}$	Y	1	Y	n/a	Y	N
4	N	N	Y	450	$\frac{428}{579}$	N	n/a	Y	n/a	Y	N
5	N	N	N	360	$\frac{38}{75}$	Y	1	Y	n/a	Y	N
6	N	N	N	450	$\frac{68}{125}$	N	n/a	N	W	N	Y

1969 STUDENT ENTRY (cont.)

	1	2	3	4	5	6	7	8	9	10	11
number	veteran	previous college	fishing background	av'ge score aptitude tests	high school class rank	graduate	level of graduation	completed two years	withdrew/dissmised	entered fish. ind.	continued education
7	N	Y	N	-	-	Y	1	Y	n/a	N	Y
8	N	Y	Y	-	$\frac{26}{53}$	Y	1	Y	n/a	Y	N
9	N	N	N	-	-	Y	4	Y	n/a	Y	N
10	N	N	Y	390	$\frac{93}{226}$	Y	1	Y	n/a	y	Y
11	N	N	Y	340	$\frac{61}{103}$	N	n/a	N	W	Y	N
12	N	N	N	300	$\frac{187}{226}$	N	n/a	N	W	N	N
13	N	N	N	450	$\frac{3}{4}$	N	n/a	N	W	N	N
14	N	N	Y	620	$\frac{82}{209}$	Y	1	Y	n/a	Y	N
15	Y	Y	N	-	-	Y	3	Y	n/a	Y	N
16	N	N	N	-	-	Y	1	Y	n/a	N	Y
17	N	Y	Y	B.S. degree		Y	1	N*	n/a	Y	N
18	N	N	N	430	$\frac{29}{56}$	N	n/a	N	W	N	N

\*Completed in one year of residence

1970 STUDENT ENTRY

1	N	N	N	550	$\frac{61}{434}$	N	n/a	N	W	Y	N
2	N	Y	Y	380	$\frac{329}{357}$	N	n/a	N	W	y	Y
3	N	Y	N	-	$\frac{53}{123}$	N	n/a	N	W	N	N
4	N	N	N	-	$\frac{157}{195}$	N	n/a	N	W	N	Y
5	N	Y	Y	600	$\frac{3}{10}$	Y	2	Y	n/a	Y	N

1970 STUDENT ENTRY (cont.)

	1	2	3	4	5	6	7	8	9	10	11
number	veteran	previous college	fishing background	av'ge score aptitude tests	high school class rank	graduate	level of graduation	completed two years	withdrew/dissmissed	entered fish. ind.	continued education
6	N	N	Y	-	$\frac{413}{480}$	N	n/a	N	W	Y	N
7	N	N	N	395	$\frac{4}{6}$	N	n/a	N	D	N	Y
8	N	N	N	395	$\frac{371}{621}$	Y	1	Y	n/a	Y	N
9	N	N	Y	485	$\frac{40}{215}$	N	n/a	N	W	Y	N
10	N	N	N	500	$\frac{130}{201}$	N	n/a	N	W	N	Y
11	N	N	Y	460	$\frac{91}{102}$	N	n/a	N	D	N	Y
12	N	N	Y	490	$\frac{42}{215}$	N	n/a	Y	n/a	Y	N
13	N	Y	Y	480	$\frac{125}{171}$	Y	1	Y	n/a	N	Y
14	Y	Y	Y	640	$\frac{142}{231}$	Y	1	Y	n/a	N	Y
15	Y	Y	Y	-	$\frac{115}{125}$	Y	1	Y	n/a	Y	N
16	N	N	N	495	$\frac{35}{224}$	N	n/a	N	W	N	N
17	N	N	Y	405	$\frac{14}{56}$	N	n/a	N	W	Y	N
18	N	N	N	550	$\frac{60}{143}$	N	n/a	N	W	N	Y
19	N	N	Y	515	$\frac{171}{215}$	Y	1	Y	n/a	Y	N
20	N	N	Y	495	$\frac{44}{50}$	Y	1	Y	n/a	Y	N
21	N	N	N	425	$\frac{130}{268}$	N	n/a	N	W	N	N
22	Y	Y	Y	-	$\frac{10}{99}$	Y	2	Y	n/a	Y	N
23	Y	Y	N	B.S. degree		N	n/a	N	W	N	N
24	N	N	N	405	$\frac{310}{374}$	N	n/a	N	W	N	N
25	Y	N	Y	-	$\frac{199}{336}$	N	n/a	N	W	N	Y

1970 STUDENT ENTRY (cont.)

	1	2	3	4	5	6	7	8	9	10	11
number	veteran	previous college	fishing background	av'ge score aptitude tests	high school class rank	graduate	level of graduation	completed two years	withdrew/dismised	entered fish. ind.	continued education
26	N	N	N	625	$\frac{47}{185}$	Y	2	Y	n/a	Y	N
27	N	N	Y	570	$\frac{74}{164}$	N	n/a	N	W	N	N
28	N	N	Y	565	$\frac{141}{209}$	N	n/a	N	W	Y	N
29	Y	Y	N	565	$\frac{179}{257}$	Y	1	Y	n/a	y	Y

## APPENDIX K

### LIST OF SCHOLARSHIPS

The following scholarship aid has been made available specifically for students in the Two Year Commercial Fisheries Program:

1. Kelvin Hughes Scholarship - Donor: Kelvin Hughes  
Division of Smiths Industries, Inc., Mass.

The sum of \$500 annually; award decisions to be the responsibility of the Program Director. Criteria established for the award were: second year student, financial need, demonstrated ability in the program, potential for a successful career preferably in the sea-going sector of the commercial fishing industry. Practice has been to award the full sum to a single student.

2. The National Fisheries Institute, Inc. - Donor: National  
Fisheries Institute, Inc., Washington, D.C.

The sum of \$500 annually; award decisions to be the responsibility of the Program Director and Faculty, based on financial need, ability and potential for success in any phase of the fishing industry. Practice has been to award the total amount each year to a single second year student.

3. Donor: Ashaway Line and Twine Company, Ashaway, R.I.

The sum of \$450 annually, to students in need of financial assistance to complete the program. Practice has been to divide the sum between one or two students, either first or second year, based on needs.

4. Donor: Eppley Foundation for Research, Inc., Newport,  
R.I.

The sum of \$500 annually, to students in need of financial assistance to complete the program. Practice has been to divide the sum between two or three students, either first or second year, based on needs.

5. Donor: The Women's Seamen's Friends Society of  
Connecticut, Inc.

Up to \$2000 annually to students resident in Connecticut who need financial assistance to complete the program. Practice has been to divide the available sum between those students from Connecticut who are in need of financial assistance to continue work in the program.

311/312

207



## APPENDIX L

### MAJOR ITEMS OF EQUIPMENT

#### Engineering

- 1 - GM 6-71 diesel engine with hydraulic marine gear and front end power take off
- 1 - Gray Marine (GM) 6 cyl. diesel engine
- 1 - Cummins C160 diesel engine
- 1 - Caterpillar D330 diesel engine
- 1 - Superior 4 cyl. diesel engine
- 1 - Lister SL 1 diesel engine
- 1 - Cutaway powered demonstration D330 Caterpillar diesel engine
- 1 - Cutaway GM 6-71 diesel engine
- 1 - 20HP Mercury Outboard motor
- 1 - Air compressor and tank unit
- 5 - electric motors of various HP
- 1 - complete laboratory hydraulic system
- 1 - Hathaway four barrel winch, hydraulic with air controls
- 1 - complete mast, boom, winch, topping, gilson and vanging hydraulic rig, custom built
- 1 - backhoe demonstration rig
- 1 - self-draining hydraulic set-up bench, custom built
- 1 - hydraulic test stand
- 1 - drill press
- 1 - bench grinding machine
- 1 - portable grinding machine
- 1 - two ton falls on overhead travelling beam
- 1 - half ton falls on overhead travelling beam
- 1 - portable exhaust system to outside silencer
- 1 - 200 amp a.c./d.c. electric welding machine
- 1 - 180 amp a.c. electric welding machine
- 2 - sets oxy-acetylene welding and burning outfits
- 1 - Marco hydraulic winch model W1100
- 1 - Marco power block model 19A
- 1 - Marco gear reducer, 35HP
- 1 - Marco gillnet block model 13A
- 1 - Hydroslave Junior line hauler
- 3 - Marco W0650 vang winches

#### Electrical

- 1 - simulated small fishing vessel electrical system including battery, alternator, generator, starter, shore charge connection, light and power loads, ignition system.
- 4 - variable d.c. power sources
- 4 - test meters
- 4 - d.c. motors, various types
- 4 - a.c. motors, various types

313/314

## Electronics

- 1 - Kelvin Hughes radar plotting table/simulator
- 2 - Bendix MR3 radar sets
- 1 - Apelco radar set
- 1 - Decca RM326 radar set with magnifier and variable range marker
- 1 - APN9 loran set
- 1 - Enac Triton DX Navigator Comm-X150 loran set
- 2 - Kelvin Hughes LJII loran sets
- 1 - Kelvin Hughes loran simulator transmitter
- 1 - Simrad Basdic F80 Fish Finder
- 1 - Wesmar SS200 sonar set with stabilized transducer head
- 1 - Simrad Partner sounding machine with Simrad scope, bottom input and fish simulation system
- 1 - Elac LAZ16 Gray Line sounding machine
- 1 - Kelvin Hughes MS37 sounding machine
- 1 - Raytheon flasher sounding machine
- 1 - Furuno FRN20 Net recording system
- 2 - Decca Mark 12 Decometers
- 1 - Decca Navigator simulator type 2536A
- 1 - Merriam Marine Electronics Fishscope
- 1 - Raytheon standard band radio telephone
- 1 - Portable Konel VHF FM radio telephone
- 2 - Konel VHF FM marine radio telephones
- 2 - Oscilloscopes

## Fishing Gear

- 2 - sets standard trawl doors
- 2 - sets shrimp doors
- 1 - set 2 sq.m. Suberkrub doors
- 1 - 800 ft. Menhaden purse seine with end bunt
- 1 - Canadian Diamond trawl
- 1 - Hillier midwater trawl
- 1 - Hillier high opening bottom trawl
- 2 - Irish wing trawls
- 1 - Scottish Seine
- 1 - Krawiec Wing Trawl
- 1 - Standard Yankee 35 bottom trawl
- 1 - three-quarter size Yankee 35 bottom trawl
- 1 - standard 8 ft. scallop dredge
- 1 - standard 6 ft. scallop dredge
- 1 - 20 ft. beam trawl
- 2 - long line sets
- 6 - monofilament gill nets
- 24 - standard inshore lobster pots, various designs
- 1 - net drum, 36 ins. diameter by 60 ins. long, double flange
- 1 - purse line reel
- 1 - purse ring tray

- 1 - purse davit
- 2 - 21 ft. booms for double rig trawling
- 2 - riggers vises
- 1 - sweep wrap device

#### Fishing Vessel Models

- 1 - 240 ft. stern freezer factory vessel
- 1 - 160 ft. wet fish stern trawler
- 1 - 65 ft. stern drum trawler
- 1 - 72 ft. double ring Gulf shrimp trawler
- 1 - 50 ft. scottish seiner
- 1 - 80 ft. eastern rig dragger
- 1 - 50 ft. purse seiner

#### Meteorology

- 1 - remote reading weather station for wind speed and direction
- 1 - thermograph
- 1 - barograph
- 1 - hygrometer
- 2 - mercurial and aneroid barometers
- 2 - outside thermometers
- 2 - maximum and minimum thermometers

#### Navigation

- 1 - Hubbard/Baader miniature planetarium
- 5 - Hubbard demonstration models of solar system and earth-moon-sun system
- 3 - Plathe marine sextants
- 1 - bubble sextant
- 2 - hand bearing compasses
- 2 - magnetic compasses
- 5 - station pointers
- 1 - deviascope

#### Seamanship

- 2 - dummy man-overboard light/smoke floats
- 1 - rocket line throwing apparatus
- 1 - full scale working rig of mast and derrick with working winches, custom built
- 1 - riggers vise

#### Vessels

- 1 - 47 ft. training vessel
- 1 - 18 ft. work/seine skiff
- 1 - 30 ft. double ended surf boat
- 2 - Nova Scotia dories

Visual Aid Equipment

- 1 - 16 mm sound film projector
- 1 - 35 mm carousel slide projector
- 1 - overhead projector
- 1 - self contained rear screen 8 mm film cartridge projector
- 1 - wall screen

Woodworking Equipment

- 1 - 8 inch table saw
- 1 - 10 inch band saw
- 1 - portable circular saw
- 1 - portable sanding machine

APPENDIX M  
TRAINING VESSEL PARTICULARS

OUTLINE SPECIFICATION FOR TRAINING VESSEL "GAIL ANN"

Built: Stonington, Connecticut, 1956

Radio Call: WH 3656

Principal Particulars:

Length overall	45' - 6"
Length between perpendiculars	43' - 4"
Breadth molded	14' - 2-1/2"
Depth molded	6' - 3"
Mean draft at datum waterline	4' - 11-1/2"
Displacement to datum waterline	19.2 long tons
Gross tonnage	25.5
Net tonnage	16.4

Speed: 8.5 knots

Arrangement: Working deck aft, wheelhouse with engine room below, galley, head, forecastle with two berths.

Fishing Methods: Stern trawling with net drum or quarter rope handling, twin rig trawling, beam trawling, midwater trawling, purse seining, potting, gillnetting, longlining.

Construction: Wood, hull planking 1-1/2 inch mahogany, frames 1-1/4 in. by 2-3/4 in. double, frame spacing 11 in. centers.

Capacities: fuel: 400 gals.  
fresh water: 50 gals.

Main Engine: GM 4-71, 96 BHP at 1800 rpm.  
marine gear: Allison MH 3:1  
front end power take off: Twin Disc 35 HP  
generator: 0.5 kw, 12 v.

Propeller: 34 in. by 26 in.

A.C. Generator: 6.5 kw, 110 v., driven by 2-cyl. Onan diesel.

Bilge Pumps: 1 - 1-1/4 in. 110 v., a.c., 30 gpm, manifold to fish hold, engine room, lazarette.  
1 - Lovett 12 v., d.c., 5 gpm, to engine room, manual or automatic operation.  
1 - Edson 2 in. hand diaphragm pump on main deck, to fish hold.

318/319

Electrical Systems:

- a.c. system: 110 v., with centralized circuit breaker distribution; power outlets in wheelhouse and accommodation, 2 - 1-1/2 kw electric heaters in wheelhouse and galley, deck working lights, sonar, main radar, fishscope, Decca Navigator, bilge pump. Powered from a.c. generator or shore power connection.
- d.c. system: 12 v. with centralized circuit breaker distribution; two banks of two - 8D marine batteries with charging from main engine, a.c. generator engine, or shore power. Outlets in wheelhouse and galley, navigation lights, lights throughout accommodation, radio telephone, VHF radio, back-up radar, flasher sounder, gray line recorder, fresh water system, d.c. bilge pump, emergency deck lights, main engine starting, a.c. generator starting.

Deck Machinery: Hydraulic.

- Main winch: Marco model W1100  
Net Drum: 36in. diam. by 60in. long, double end flange with inner flange cut down. Gear reducer is Marco G2051 - M2 - 210 - 35.  
Power block: Marco 19A 1050GR.  
Gillnet block: Marco 13A.  
Line Hauler: Hydroslave Junior.  
Topping lift winch: Marco W0650 vang winch.

- Hydraulic System: Double pump driven from main engine front end power take off. Pump: Vickers double 11 gpm and 22 gpm, 33 HP at 1500 psi; heat exchanger, 30 gal. reservoir. Equipment operated by system: main winch 33 gpm, topping lift winch 11 gpm, power block 11 gpm, gillnet block 11 gpm, linehauler 11 gpm, net drum 22 gpm.

Electronic Aids:

- Radar: Decca RM326 with magnifier and variable range marker. Apelco  
Loran: Enac Triton DX Navigator Comm-X 150.  
Radios: Raytheon radio telephone  
Konel VHF FM radio telephone  
Depth sounders: Raytheon flasher sounder  
Elac LAZ 16 gray line recorder  
Kelvin Hughes MS 37  
Fishscope: Merriam Marine Electronics.  
Sonar: Wesmar SS200 with stabilized transducer  
Decca Navigator: Mark 12  
Net recorder: Furuno FRN 20

Other Navigational Equipment:

Magnetic compass  
Pelorus  
Chart table and instruments  
Clock  
Barometer

Safety Equipment:

Firefighting: Engine room CO<sub>2</sub> smothering system,  
2-50 lb. bottles arranged for manual  
or automatic operation.  
1 - 5 lb. dry chemical portable ex-  
tinguisher in wheelhouse.  
3 - 2-1/2 lb. dry chemical extinguishers  
in accommodation.

Bilge water warning: magnahelic bilge gauge.

Lifesaving: 2 - standard liferings, port and star-  
board of wheelhouse, with man-overboard  
smoke/light float.  
2 - 6 man Elliot inflatable liferafts,  
on deck forward and on wheelhouse roof.  
2 - sets smoke and light flares.  
14 - standard lifejackets.  
Inflatable personal buoyancy aids to be  
worn by non-swimmers.  
Emergency horn.  
Liferails each side of after working  
deck.

SUMMARY SPECIFICATION FOR VESSEL "LA NINA"

Built: MARCO, Chile 1960.

Principal Particulars:

Length overall	57' - 0"
Beam	17' - 0"
Draft loaded	8' - 6"
Net tonnage	32.0

Speed: 9-1/2 knots, cruising range 1200 miles.

Arrangement: Standard Marco design; open work deck aft, pilot house forward with galley, head, seven berths.

Fishing Method: Stern trawling with quarter rope net handling.

Construction: V-bottom steel.

Capacities: fuel: 1800 gals.  
fresh water: 800 gals.  
reefer: 12 cu.ft.

Main Engine: GM 6-71, 160 BHP at 1800 rpm. Front end power take off driving hydraulic pump; generator 0.3 kw, 32v.d.c.

Electrical System: 110 v. a.c., 32 v. d.c.

Deck Machinery:

Main winch: Marco double drum hydraulic, 100 fathoms of 1/2 inch wire on each drum.  
Windlass: Marco hydraulic  
Topping Lift: Marco hydraulic

Electronic Aids: Radar: Decca 202  
Loran: Kelvin Hughes  
Depth sounder: Kelvin Hughes paper recorder  
Radio: 85 watt radio telephone

Other Navigational Equipment:

Magnetic compass  
Chart table and instruments  
Clock

Safety Equipment: Lifejackets  
Flares  
Dry chemical fire extinguishers  
12 man inflatable liferaft  
liferings



NOTES ON U.S. COAST GUARD REQUIREMENTS FOR INSPECTION AND  
LICENSED PERSONNEL WITH REFERENCE TO TRAINING VESSELS

All powered vessels operated from the United States are subject to the Rules and Regulations established and administered by the U.S. Coast Guard under various acts of Congress. The extent and depth of the rules and regulations applicable to any particular vessel depends on the size of that vessel and its manner of use.

The first task of anyone contemplating the acquisition and use of any vessel should be, therefore, to gain a full understanding of the regulations which may be applicable. This is best achieved by direct contact with the Officer in Charge, Marine Inspection, at the nearest port having a Coast Guard Marine Inspection office. This officer will provide publications detailing the various Rules and Regulations, and can provide valuable guidance as to the manner in which they may be interpreted to apply to the particular operation in question.

A vessel associated with training activities may be classed as an Oceanographic Research Vessel, a Nautical Schoolship, a Miscellaneous Vessel, or an Uninspected Vessel, depending on its size and use. Special regulations exist for Oceanographic vessels above 300 gross tons; Nautical Schoolships operated by a civilian institution are required to meet the stringent requirements applicable to passenger ships; miscellaneous vessels may be treated as uninspected vessels if they are below 300 gross tons, but above that size they come under more extensive regulations.

In general, it appears that the Schoolship classification applies to vessels whose prime purpose is to train students for the merchant marine, and which berth students aboard for lengthy periods. Oceanographic vessels below 300 gross tons may be classed as Miscellaneous or Uninspected. Fishing Vessels are all classed as Uninspected vessels.

If a vessel is operated on a daily basis without permanent berthing for students, and does not undertake extended offshore trips, then it appears likely to be classed as a Miscellaneous or Uninspected vessel, if below 300 gross tons, as was the case with the training vessel GAIL ANN during this project. It should be noted here that licensed personnel are required aboard Uninspected vessels of over 200 gross tons.

Uninspected vessels are not subject to Coast Guard regulations regarding construction, or to regular

inspections, but have to meet requirements regarding lifesaving and firefighting equipment. They represent a most inexpensive alternative to the other classifications where heavy expenses can be incurred in bringing a vessel up to the standard and maintaining that standard.

A DAY ON THE "GAIL ANN"  
(by Harry Snow, Class of 1971)

Let's sit in on a typical afternoon trip for first-year students on the URI schoolship, "Gail Ann."

Each duty station on the boat has been assigned to a student, and on other trips, each student will eventually fill each position at least once. For today's trip, the student Captain, Navigator, and Engineer are at the vessel a half hour before sailing time. The Captain checks the vessel over carefully to be sure it's ready for the mission. The Navigator breaks out the charts, and they look them over for an operating area. The Engineer, meanwhile, begins his routine of mechanical checks and maintenance tasks.

Shortly before sailing, the faculty instructor for the trip sits down with the Captain and Navigator and goes over the plan of action, including the method to be used in leaving the dock, courses to be followed, fishing gear to be used, etc.

This done, and the balance of the crew having arrived, the student Captain proceeds to execute his plan. He acts independently, unless the instructor feels it necessary to override his authority to keep the operation running smoothly or to make an instructive point.

The Captain goes over his itinerary with the Navigator, who then will be prepared with the proper compass courses and who will be selecting radar targets for establishing position.

The Engineer is very busy at this time starting the auxiliary diesel generator, switching from shore to ship's power, pumping bilges, greasing equipment, checking fluid levels, and making sure that all lights, gauges, and equipment are operating properly. Any malfunctions are reported and resolved, and when the ship is ready for sea, he informs the Captain.

The Captain confers with the Mate, who has charge of all deck and fishing operations. They discuss how lines are to be handled when leaving the dock and where and how the fishing will be done. The Mate directs the two or three deck hands--the lowliest of the lowly is last week's Captain--who handle the lines and nets.

All aboard now having been briefed on the purpose and destination of the trip, and with the instructor aboard, the Skipper signals the Mate, lines are cast off

--except, perhaps, for a spring line to aid in warping the vessel into the stream--and we're off!

For the next few minutes everyone is busy. The Captain keeps the wheel as he cons the boat through the narrow Wickford channel.

The Navigator readies the first course for the first leg from the breakwater; he has the radar, depth sounder, ship-to-shore radio, and fish-finding sonar on standby, and he notes each event in the ship's log.

The Engineer checks the gauges to be sure engine pressures and temperatures are normal, and he sees that the hydraulic winch is ready for service. The Mate supervises the stowage of mooring lines and other extraneous gear and checks the winch with the Engineer.

On the way to the fishing area the trawl doors are hoisted over the side to their position at either gallows at the stern. During such operations requiring power to the winch or net reel, the Engineer stands at the hydraulic controls, ready to cut power immediately in the event of any emergency. The net is run off the reel and examined for tears or holes. (If any are found, out come the twine and needles and hands fly as the mending techniques learned in the twine lab are put to practical use.) At this time the Mate ties the "cod-end" knot (to make a bag for trapping the fish) at the end of the net. When all the fishing gear is ready, the Mate so advises the Captain.

Now there's a little time to relax--at least, for the Engineer and deck crew. The Captain may appoint a deckhand to steer, giving him the compass course set by the Navigator, who is a busy boy indeed. He must constantly check the vessel's position with visual reference to buoys, landmarks, and other vessels; with the depth sounder, and by radar bearings and ranges.

Once at the fishing ground, the Captain gets from the Navigator a point of departure for the tow and notifies the Mate that he may shoot the net. The Engineer cuts in the power takeoff and stands by the hydraulic controls. The cod-end goes over; and, as the net drum unwinds, the rest of the net follows, streaming astern. Finally the buoyed head rope and weighted sweep rope go over, and the Mate watches carefully as the towing bridles unwind. Next the chains from the two doors are attached; a little more net rolls off the drum and the doors have the load; the drum is disconnected and the set is ready.

The Mate is at the winch and, releasing the brakes, he pays out the towing warps slowly and evenly, watching carefully to see that the doors spread properly. Now the warps are all out, the brakes are set, and the vessel's power is increased to full towing power. The Captain orders a basket lashed in the rigging--the international signal for a vessel trawling.

For the first half of the 30-minute tow all is routine--but what's this? Fog, slowly but inexorably, has been creeping in. The Navigator, using the radar range finder, keeps the Captain informed of the range of visibility. When it drops quickly to less than a half-mile, the Captain orders the fog signal to be sounded as required by the "rules of the road." The Navigator concentrates on keeping radar contact with his local targets and constantly plots the vessel's position, at the same time checking for the presence of other vessels in the area.

The Captain posts one of the hands forward as a fog lookout and advises the Navigator of each action for entry in the log.

Soon the Captain orders the net hauled. The Engineer mans the power controls, the ship's speed is slowed, and the Mate brings the warps in on the winch. The trawl doors slam in to the gallows, the hands secure the dog chains, and the load is transferred to the net reel which begins to bring in the net. A host of gulls does an anticipatory dance astern. Finally the head-rope floats break water; the wings and belly come aboard with a scattered mixture of kelp, crabs and a few gilled fish. Then the cod-end floats close astern, bulging with fish!

A line is passed around the narrow cod-end ahead of the bulge, and the "gilson"--a hoisting line from the boom overhead--is attached. The Mate drops a few turns around the revolving warping head, and the bag comes handily aboard. A hand jerks the cod-end knot loose, the bag bursts open, and a load of silvery, flopping fish hits the deck.

Now the deckhands have a job. "Fish picks" flying, they quickly toss the "good" fish into baskets--cod, flounder, etc.--and kick, shovel, and wash the trash over the side. In a few minutes the job is done; the vessel is turned and set for another tow. The net is shot again, and the crew cleans off the deck, hosing it down, and sets to filleting a few fish for supper.

The Captain confers with the faculty adviser. Visibility has closed to a quarter-mile. It's nearly 4:00 p.m. and darkness will set in early tonight. They decide it would be discreet to make this a short tow and head for home. The net is hauled again; this time it yields a much smaller bag, but with four large cod in it!

With the net aboard and the power takeoff secured, the Captain orders the signal basket in, and increases the speed a bit--but not too much. The ship is in a reduced visibility area and must, according to the rules, "go at a reduced speed and navigate with caution." The Navigator sets the course for home and watches the radar closely for signs of any "strangers" on the screen.

The Captain discusses his docking plan with the adviser, and with agreement on the plan, imparts it to the Mate. He gets the lines ready and instructs his crew. The Captain retains the helm coming into the harbor. The ship rounds the last buoy and steams slowly to the dock, then heads around into the tide. A bow spring line goes out and is made fast. Slow ahead on the spring, and "Gail Ann" nestles up to the dock. Mooring lines are made fast, shore power is hooked up, and all engines are secured. The vessel is cleaned, aloft and below, to the Captain's satisfaction. He inspects the log, the deck, the engine room, and cabin. When satisfied, he must "sell" his ship to the instructor.

And next time? Our good Captain becomes a deck-hand, the first step in working his way up again. Each job, taken in rotation, has its own problems, but each time it becomes easier until, at the end of the semester, the crew has become a real team.

APPENDIX N  
REPORT OF SURVEY EVALUATION BY  
NEW ENGLAND RESOURCE CENTER  
FOR OCCUPATIONAL EDUCATION



New England  
Resource Center  
for Occupational Education  
at E|D|C 55 Chapel St., Newton, Mass. 02160  
(617) 969-7100 Cable NERCOE

A SURVEY REPORT

on

The Two-Year Associate Degree Program in Commercial  
Fisheries at the University of Rhode Island

Conducted by: The New England Resource Center for Occupational  
Education

Date: June 20, 1972

Thomas H. Sandham, Jr., Associate Director, and Peter Fellenz, Coordinator, Evaluation Services of NERCOE surveyed the progress of the above program through discussion with those of long and deep involvement with it. (See Chapter VIII to this report for listing of those involved.)

As concrete evaluative data is substantial in Dr. Sainsbury's final report, our purpose was to analyze the most basic aspects of the program in terms of initial expectations. With this understanding the following conclusions and recommendations may be stated.

CONCLUSIONS:

1. The securing of the present waterfront site was the turning point for this successful program. Before water frontage was secured both student and faculty involvement was low. It is the site too which has contributed to substantial involvement of neighboring commercial fishermen.
2. The program administration has also greatly expanded its work quarters so that the present site includes fine facilities for working with large gear and equipment items. Thus, not only the training vessel but also the lab for gear and equipment development and training are within seconds of the classroom setting. The original training vessel has been designed with equipment used in the industry and is now a model for this kind of program.

329/330

(2)

3. Although the initial curriculum was overburdened with general college introductory courses, the present curriculum is almost totally adapted to the interests and needs of the fisheries students. Input from multiple students, faculty and advisory committee members is a normal part of this curriculum revision process. The continuing support of the University of Rhode Island is also most significant.
4. The present staff consists of people with ongoing involvement in the fisheries industry. Reliance on part-time local staff has been essential in developing this responsive staff. Early and deep involvement of local fisheries people may be considered one of the major reasons for the success of this program.
5. The original student enrollment projections of forty first year and forty second year students has not been met. Present enrollment is approximately 32-35 first year and 18-20 second year. The staff reports that the program is now attracting more and better informed students with a greater interest in the fishing profession.
6. Many graduates are being placed with the local fleet and are establishing a good reputation in the industry. Others are moving into related occupations or continuing their academic education.

### RECOMMENDATIONS

Recognizing that final recommendations for program improvement should be based upon a comprehensive study of Dr. Sainsbury's final report and upon an ongoing relationship with the program, the following tentative recommendations are made:

1. A long-range plan for a permanent site should be developed. As present success is dependent upon local fisheries involvement so could long term success be built upon involvement of students, graduates, and fisheries personnel from throughout the New England Region now being served.
2. Although the present curriculum is essentially skills oriented and related to the industry, the skills should continue to be clearly articulated and checked so that any tendency to measure or reward classroom or academic skills rather than practical sea skills will be overcome.
3. Finally, as the program is presently producing valuable students through substantial local involvement, the continuation and greater State funding support is fully justified.



## APPENDIX O

### DONATION SOURCES

The following companies have provided equipment or training aids for use in the program as donations, at nominal cost or on a permanent loan basis:

1. Caterpillar Tractor Co.
2. Cummins Engine Co.
3. Hathaway Machinery Co., Fairhaven, Mass.
4. ITT Decca Marine Inc., New York.
5. Kelvin Hughes Division of Smiths Industries Inc., Woburn, Mass.
6. Marine Construction and Design Co., Seattle, Wash.
7. Marine Products Co.
8. Merriam Marine Electronics Inc., E. Greenwich, R.I.
9. R. A. Mitchell Co., Inc.
10. Rhode Island Engine Co., Pt. Judith, R.I.
11. Scandia Propeller Service and Supply Co., Fairhaven, Mass.
12. Simonson Radio Inc., New York.
13. Twin Disc Inc., Racine, Wisc.
14. Western Marine Electronics, Seattle, Wash.

332/333

304